



**FİYAT LİSTESİ**  
PRICE LIST  
2023-2

mutlusan.com.tr

*Kalite, İnovasyon, Teknoloji*

*40.yıl*



**YENİ ÜRÜN**  
**YAKINDA**

**SİZ KEYFİNİZE BAKIN,**

**CİHAZLARINIZI**  
YÜKSEK GERİLİM  
DALGALANMALARINDAN

**BİZ KORURUZ**



**ŞOK KORUMALI PRİZ**

# içindekiler

## anahtar priz grubu

Rita Serisi	4
Elitra Plus Serisi	10
Candela Serisi	15
Bron Serisi	21
Nemliyer Serisi	23
Grup priz ve Aksesuarlar	25

## kablo kanalları, plastik, tesisat ve aydınlatma grubu

Canalex serisi kapalı tip kablo kanalları	36
Eko serisi kapalı tip kablo kanalları	36
Yapışkan bantlı kapalı tip kablo kanalları	36
Meks serisi kapalı tip kablo kanalları	37
Meks serisi klima kanalı ve aksesuarları	37
Tavan köşe kanalı	37
Süpürgelik kablo kanalları	37
<b>Fugalı süpürgelik</b>	37
Tezgah süpürgeliği	37
Balık sırtı zemin kanalları	37
H.Free flaret kanal ve aksesuarları	38
Kanal aksesuarları	39
Meks plus serisi için priz setleri	41
Kanal için ups ve enerji prizleri 45x45	42
Kablo toplama spirali ve kablo omurga kanalı	45
Sidem serisi renkli kablo kanalları	46
Sidem serisi süpürgelikler ve aksesuarları	46
Comfort w otomat kutuları	50
Comfort zayıf akım kutuları	50
Meksbox w otomat kutuları	51
Kablolu spiraller	52
H. Free spiraller	53
Plastik spiraller	54
Hdpe koruge borular	55
Logar kutuları	55
Eko serisi çelik ve izole kaplı spiraller	56
Meks serisi çelik ve izole kaplı spiraller	56
Metal rakorlar	57
Pvc boy borular ve aksesuarları	58
Fiber klavuz, çelik susta ve plastik sustalar	58

<b>H.Free borular</b>	59
Kalın boy boru ve dirsek-muflar	59
PVC Buat Aksesuarlar	60
Polietilen yeraltı boruları	61
Kasa, buat ve kapakları	63
Beton çivili kroşeler	69
Dübelller, vidalar ve kroşeler	69
Kapı otomatığı, trafolar, ziller ve butonları	70
Telefon dağıtım kutu ve aksesuarları	70
Döner, flaşör lambaları ve motorlu sirenler	71
ME-FAN Aspiratör Çeşitleri	72
Mutlusan Aspiratör Çeşitleri	73
Led armatür çeşitleri	75
Armatür çeşitleri	76
Bahçe armatürleri	80
Exit - acil aydınlatma armatürü	81

## pano ve endüstriyel grubu

Promex delikli kanallar	85
Delikli kablo kanalları	86
Abs panoları	88
Abs otomat panoları	89
Pano prizleri	90
Abs pano aksesuarları	91
Pano termostat ve fanları	92
Pano ısıtıcı ve güç kaynakları	101
Polyamid spiral ve aksesuarları	103
Süper etanj plastik rakorlar	103
Kablo bağları ve yapışkan kroşeler	104
Pano spiralleri	105
Ray klemensler ve dağıtım üniteleri	106
Geçmeli ve tırnaklı tip buat klemensler	108
Klemensler	108
Yüksükler	109
Baralar	110
Skp çeşitleri	111
Sanayi tipi kauçuk fiş ve prizleri	112
Cee norm fiş ve prizler	114
Termoplastik buatlar ve kombinasyon kutuları	118
Kombinasyon panoları	120
<b>Sinyal ve kumanda butonları</b>	<b>122</b>
Kumanda ve vinç kutuları	124
Butonlar ve potansiyometre	125
Ampermetre ve voltmetre	133
İkaz lambaları ve sirenler	135
Eko Serisi	138
Promex Plastik Kablo Rakoru	139



# ANAHTAR PRİZ GRUBU

# YENİ RENKLER YENİ BAŞLANGIÇLAR

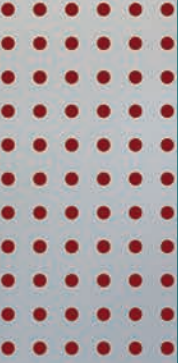
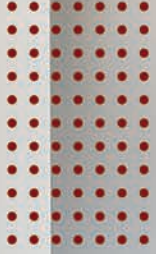

««« Rita  
SERİSİ

ANTRASİT



# Ritä

Modern tasarımlar,  
kusursuz çözümler...



**ANAHTAR GRUBU VİDALI TİP**

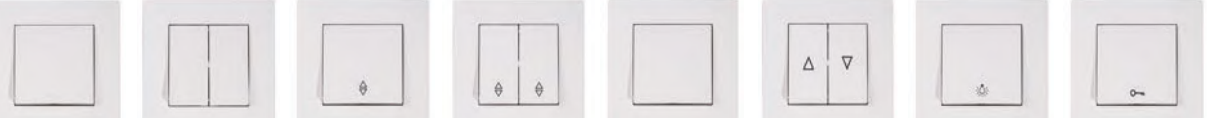

2220 401 02XX Anahtar  
2220 402 02XX Komütatör  
2220 403 02XX Vavien (iki Yollu Anahtar)  
2220 404 02XX Komütatör Vavien  
2220 405 02XX Çift Kutuplu Anahtar  
2220 406 02XX Jaluzi Anahtar  
2220 407 02XX Çağırma  
2220 407 02XXX Kapı Otomatijli Anahtar



2220 407 02XXX Zil Anahtar  
2220 408 02XX Deviyatör(Ara Vavien)  
2220 409 02XX Üçlü Anahtar  
2220 411 02XX Şofben Anahtar  
2220 415 02XX Işıklı Anahtar (220V)  
2220 416 02XX Işıklı Vavien (220V)  
2220 417 02XX Işıklı Çağırma (220V)  
2220 418 02XX Işıklı Etik. Anahtar (220V)  
2220 419 02XX Işıklı Etik. Çağırma (220V)



2220 422 02XX Işıklı Zil Etik. Çağırma (12V)  
2220 425 02XX Tek Tuşlu Jaluzi Anahtar (Vidalı)  
2220 426 02XX Işıklı Komütatör  
2220 436 02XX Jaluzi Anahtar (Yaysız - Vidalı)  
2220 401 01XX Anahtar  
2220 402 01XX Komütatör  
2220 403 01XX Vavien (iki Yollu Anahtar)  
2220 404 01XX Komütatör Vavien

**ANAHTAR GRUBU KLİPSLİ TİP (KOLAY BAĞLANTI)**



2220 405 01XX Çift Kutuplu Anahtar  
2220 406 01XX Jaluzi Anahtar  
2220 407 01XX Çağırma  
2220 407 01XXX Kapı Otomatijli Anahtar  
2220 407 01XXX Zil Anahtar  
2220 408 01XX Deviyatör(Ara Vavien)  
2220 409 01XX Üçlü Anahtar  
2220 415 01XX Işıklı Anahtar (220V)  
2220 416 01XX Işıklı Vavien (220V)

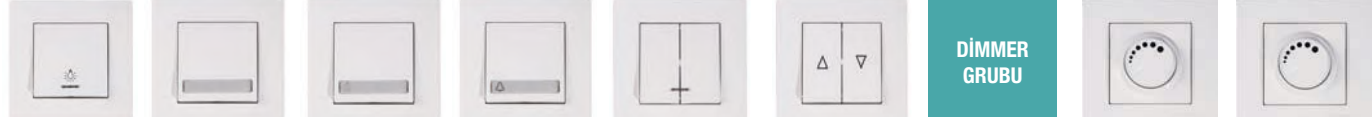

2220 417 01XX Işıklı Çağırma (220V)  
2220 418 01XX Işıklı Etik. Anahtar (220V)  
2220 419 01XX Işıklı Etik. Çağırma (220V)  
2220 422 01XX Işıklı Zil Etik. Çağırma (12V)  
2220 426 01XX Işıklı Komütatör  
2220 436 01XX Jaluzi Anahtar (Yaysız - Klipsli)  
2220 440 02XX RL Işıklı Dimmer 600W  
2220 444 02XX RL Işıklı Dimmer 1000W

**DİMMER GRUBU**



2220 447 02XX RC Dimmer 325W  
2220 450 01XX Energy Saver G.sız Işıklı  
2220 452 01XX Energy Saver Gecikmeli Işıklı  
2220 470 02XX Müzik Yayın Anahtar  
2220 480 01XX Hoparlör Prizi  
2220 485 02XX Uyarı Zili  
2220 495 02XX Hareket Sensörü

**ELEKTRONİK GRUBU**

**PRİZ GRUBU**



2220 600 02XX Tonraklı Priz  
2220 601 02XX Tonraksız Priz  
2220 605 02XX Topraklı Priz (Ç.K.)  
2220 606 02XX Topraksız Priz (Ç.K.)  
2220 610 02XX Kapaklı Topraklı Priz  
2220 611 02XX Kapaklı Topraklı Priz (Ç.K.)  
2220 615 02XX Ups (Fransız) Prizi  
2220 616 02XX Ups (Fransız) Prizi (Ç.K.)  
2220 617 02XX Ups Kapaklı (Fransız) Priz



2220 618 02XX Ups Kapaklı (Fr.) Priz (Ç.K.)  
2220 448 01XX Tekli Usb Şarj Prizi  
2220 449 01XX İkili Usb Şarj Prizi  
2220 200 02XX İkili Tonraklı Priz Porselen  
2220 201 02XX İkili Tonraksız Priz Porselen  
2220 202 02XX İkili Tonraklı Priz  
2220 203 02XX İkili Tonraksız Priz



2220 215 01XX İkili Ups Priz  
2220 619 02XX İkili Usb (2.4A) Topraklı Priz  
2220 125 01XX Telefon Prizi 1Xrj12 (Cat3)  
2220 126 01XX Telefon Prizi 2Xrj12 (Cat3)  
2220 128 01XX Etiketsiz T11 Data Priz (Kon.süz)  
2220 135 01XX Data Prizi 1\*Rj45 (Kon.süz)  
2220 136 01XX Data Prizi 1\*Rj45 (Cat5e)  
2220 137 01XX Data Prizi 2\*Rj45 (Kon.süz)

**İLETİŞİM GRUBU**



2220 139 01XX T11 Data Priz (Rj12 Cat3 + Cat5e)  
2220 138 01XX Data Prizi 2\*Rj45 (Cat5e)  
2220 140 01XX Data Prizi 1\*Rj45 (Cat6)  
2220 141 01XX Data Prizi 2\*Rj45 (Cat6)  
2220 455 01XX Data Prizi 1\*Usb  
2220 456 01XX Data Prizi 2\*Usb  
2220 457 01XX Data Prizi 1\*Hdmü  
2220 458 01XX Data Prizi 2\*Hdmü  
2220 459 01XX Data Prizi 1\*Usb/1\*Hdmü



2220 460 01XX VGA Priz  
2220 461 01XX İki Çıkışlı Fiber Optik Priz  
2220 121 02XX Kör Kapak  
2220 156 02XX Tv-Sat Prizi (Geçişli) 4DB/F Kon.  
2220 157 02XX Tv-Sat Prizi (Sonlu)  
2220 166 01XX Sat Prizi (Geçişli) 4DB/F Kon.  
2220 167 01XX Sat Prizi (Sonlu)  
2220 170 01XX Tv Prizi (Geçişli) 11DB

**TV / SAT GRUBU**

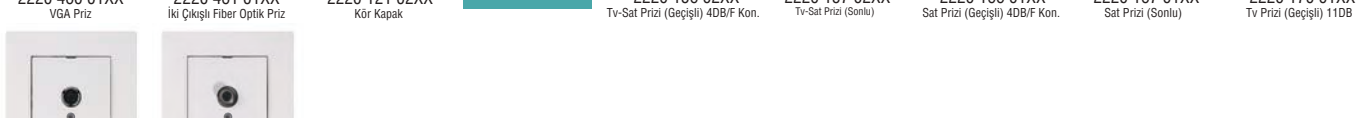

2220 171 01XX Tv Prizi (Sonlu)  
2220 172 01XX Tv Prizi F Dişi



NATURAL



01 - BEYAZ



02 - KREM

AHŞAP



56 - KIRAZ



57 - CEVİZ



58 - MEŞE

METALİK



80 - A. ALTIN



82 - İNOX



83 - TİTANYUM



84 - SİYAH



85 - DORE



86 - ANTRASİT



95 - FÜME

PASTEL



03 - GRİ



04 - KIRMIZI



06 - TURUNCU



08 - SARI



09 - LACİVERT



10 - YEŞİL



11 - PEMBE



12 - MAVİ



25 - MOR

YENİ  
RENGİMİZ



Kod	Ürün Tanımı	Kutu Adedi	Koli Adedi	Beyaz/Krem Fiyat	Metalik Fiyat	Ahşap Fiyat
-----	-------------	------------	------------	------------------	---------------	-------------

**Anahtar Grubu Vidalı Tip**

2200 401 02XX	Mek+Tuş Anahtar (Vidalı)	12	120	75,81	90,14	120,17
2200 402 02XX	Mek+Tuş Komütatör (Vidalı)	12	120	101,46	123,06	138,87
2200 403 02XX	Mek+Tuş Vavien (İki Yollu Anahtar)(Vidalı)	12	120	100,61	114,76	133,68
2200 404 02XX	Mek+Tuş Komütatör Vavien (Vidalı)	12	120	174,12	192,96	205,54
2200 405 02XX	Mek+Tuş Çift Kutuplu Anahtar (Vidalı)	12	120	114,41	133,20	145,89
2200 406 02XX	Mek+Tuş Jalu Anahtarı (Vidalı)	12	120	143,74	199,78	214,45
2200 407 02XX	Mek+Tuş Çağırma (Vidalı)	12	120	85,00	126,90	131,85
2200 407 02XXK	Mek+Tuş Kapı Otomatiği Anahtarı (Vidalı)	12	120	85,00	126,90	131,85
2200 407 02XXZ	Mek+Tuş Zil Anahtarı (Vidalı)	12	120	85,00	126,90	131,85
2200 408 02XX	Mek+Tuş Deviatör(Ara Vavien)(Vidalı)	12	120	160,81	196,41	210,62
2200 409 02XX	Mek+Tuş Üçlü Anahtar (Vidalı)	12	120	132,80	160,97	212,55
2200 411 02XX	Mek+Tuş Şofben Anahtarı (Vidalı)	12	120	155,53	194,36	211,52
2200 415 02XX	Mek+Tuş Işıklı Anahtar (220V) (Vidalı)	12	120	141,59	170,13	182,97
2200 416 02XX	Mek+Tuş Işıklı Vavien (220V) (Vidalı)	12	120	180,89	207,80	268,64
2200 417 02XX	Mek+Tuş Işıklı Çağırma (220V)(Vidalı)	12	120	148,78	218,37	226,73
2200 418 02XX	Mek+Tuş Işıklı Etik. Anahtar (220V)(Vidalı)	12	120	163,12	170,70	195,83
2200 419 02XX	Mek+Tuş Işıklı Etik. Çağırma (220V)(Vidalı)	12	120	152,99	184,96	199,65
2200 422 02XX	Mek+Tuş Işıklı Zil Etik. Çağırma (12V)(Vidalı)	12	120	215,82	240,99	277,64
2200 425 02XX	Mek+Tuş Tek Tuşlu Jalu Anahtarı (Vidalı)	12	120	171,17	212,17	232,77
2200 426 02XX	Mek+Tuş Işıklı Komütatör (Vidalı)	12	120	192,34	236,94	251,40
2200 436 02XX	Mek+Tuş Jalu Anahtarı (Yaysız)(Vidalı)	12	120	157,89	205,33	226,70



\* Çoklu çerçeve ile kullanılamaz.

**Anahtar Grubu Klipsli Tip (Kolay Bağlantı)**

2200 401 01XX	Mek+Tuş Anahtar (Klipsli)	12	120	75,81	90,14	120,17
2200 402 01XX	Mek+Tuş Komütatör (Klipsli)	12	120	101,46	123,06	138,87
2200 403 01XX	Mek+Tuş Vavien (İki Yollu Anahtar)(Klipsli)	12	120	100,61	114,76	133,68
2200 404 01XX	Mek+Tuş Komütatör Vavien (Klipsli)	12	120	174,12	192,96	205,54
2200 405 01XX	Mek+Tuş Çift Kutuplu Anahtar (Klipsli)	12	120	114,41	133,20	145,89
2200 406 01XX	Mek+Tuş Jalu Anahtarı (Klipsli)	12	120	143,74	199,78	214,45
2200 407 01XX	Mek+Tuş Çağırma (Klipsli)	12	120	85,00	126,90	131,85
2200 407 01XXK	Mek+Tuş Kapı Otomatiği Anahtarı (Klipsli)	12	120	85,00	126,90	131,85
2200 407 01XXZ	Mek+Tuş Zil Anahtarı (Klipsli)	12	120	85,00	126,90	131,85
2200 408 01XX	Mek+Tuş Deviatör(Ara Vavien)(Klipsli)	12	120	160,81	196,41	210,62
2200 409 01XX	Mek+Tuş Üçlü Anahtar (Klipsli)	12	120	132,80	160,97	212,55
2200 415 01XX	Mek+Tuş Işıklı Anahtar (220V) (Klipsli)	12	120	141,59	170,13	182,97
2200 416 01XX	Mek+Tuş Işıklı Vavien (220V) (Klipsli)	12	120	180,89	207,80	268,64
2200 417 01XX	Mek+Tuş Işıklı Çağırma (220V)(Klipsli)	12	120	148,78	218,37	226,73
2200 418 01XX	Mek+Tuş Işıklı Etik. Anahtar (220V)(Klipsli)	12	120	163,12	170,70	195,83
2200 419 01XX	Mek+Tuş Işıklı Etik. Çağırma (220V)(Klipsli)	12	120	152,99	184,96	199,65
2200 422 01XX	Mek+Tuş Işıklı Zil Etik. Çağırma (12V)(Klipsli)	12	120	215,82	240,99	277,64
2200 426 01XX	Mek+Tuş Işıklı Komütatör (Klipsli)	12	120	192,34	236,94	251,40
2200 436 01XX	Mek+Tuş Jalu Anahtarı (Yaysız)(Klipsli)	12	120	157,89	205,33	226,70

**Dimmer Grubu**

2200 440 02XX	Mek+Tuş RL Işıklı Dimmer 600W	8	80	448,67	549,27	681,87
2200 444 02XX	Mek+Tuş RL Işıklı Dimmer 1000W	8	80	570,87	884,08	964,37
2200 447 02XX	Mek+Tuş RC Dimmer 325W	8	80	1.180,73	2.134,98	2.339,33

**Elektronik Grubu**

2200 450 01XX	Mek+Tuş Energy Saver G.siz Işıklı	8	80	671,08	767,88	823,09
2200 452 01XX	Mek+Tuş Energy Saver Gecikmeli Işıklı	8	80	697,69	795,06	834,18
2200 470 02XX	Mek+Tuş Müzik Yayın Anahtarı	8	80	911,16	956,25	1.009,68
2200 480 01XX	Mek+Tuş Hoparlör Prizi	8	80	193,34	302,97	336,29
2200 485 02XX	Mek+Tuş Uyarı Zili	8	80	1.168,06	1.249,80	1.281,54
2200 495 02XX	Mek+Tuş Hareket Sensörü	8	80	1.466,19	1.709,34	1.896,46

**Priz Grubu**

2200 600 02XX	Mek+Tuş Topraklı Priz	12	120	97,80	139,84	158,47
2200 601 02XX	Mek+Tuş Topraksız Priz	12	120	84,48	117,68	147,51
2200 605 02XX	Mek+Tuş Topraklı Priz (Ç.K.)	12	120	119,09	142,21	230,09
2200 606 02XX	Mek+Tuş Topraksız Priz (Ç.K.)	12	120	95,47	122,17	171,99
2200 610 02XX	Mek+Tuş Kapaklı Topraklı Priz	12	120	126,78	150,81	169,86
2200 611 02XX	Mek+Tuş Kapaklı Topraklı Priz (Ç.K.)	12	120	135,28	174,34	202,25
2200 615 02XX	Mek+Tuş Ups (Fransız) Prizi	12	120	125,45	164,25	243,43
2200 616 02XX	Mek+Tuş Ups (Fransız) Prizi (Ç.K.)	12	120	179,27	216,84	242,28
2200 617 02XX	Mek+Tuş Ups Kapaklı (Fransız) Priz	12	120	133,79	206,09	234,01
2200 618 02XX	Mek+Tuş Ups Kapaklı (Fr.) Priz (Ç.K.)	12	120	190,30	211,53	239,46
2200 200 02XX	Mek+Tuş İkili Topraklı Priz Porselen	5	50	216,48	314,71	326,18
2200 201 02XX	Mek+Tuş İkili Topraksız Priz Porselen	5	50	163,79	215,06	254,91
2200 202 02XX	Mek+Tuş İkili Topraklı Priz	5	50	178,18	235,30	286,60
2200 203 02XX	Mek+Tuş İkili Topraksız Priz	5	50	142,90	188,48	232,76
2200 215 02XX	Mek+Tuş İkili Ups Priz	5	50	168,85	173,27	220,03
2200 448 01XX	Mek+Tuş Tekli Usb Şarj Prizi	5	50	453,74	550,14	602,20
2200 449 01XX	Mek+Tuş İkili Usb Şarj Prizi	5	50	575,28	629,02	754,16
2220 619 02XX	İkili Usb Topraklı Priz (Çerçeve Dahil)	8	-	590,43	1.022,28	1.078,90
2220 629 02XX	Rita Usb +Type-C li Topraklı Priz (Çerçeve Dahil)	8	-	696,71	1.052,94	1.140,18



Kod	Ürün Tanımı	Kutu Adedi	Koli Adedi	Beyaz/Krem Fiyat	Metalik Fiyat	Ahşap Fiyat
-----	-------------	------------	------------	------------------	---------------	-------------



### İletişim Grubu

2200 125 01XX	Mek+Tuş Telefon Prizi 1Xrj12 (Cat3)	12	120	108,83	166,11	191,45
2200 126 01XX	Mek+Tuş Telefon Prizi 2Xrj12 (Cat3)	12	120	180,81	239,05	246,13
2200 128 01XX	Mek+Tuş Etiketli Tlf Data Priz (Kon.süz)	12	120	88,27	109,56	132,41
2200 135 01XX	Mek+Tuş Data Prizi 1*Rj45 (Kon.süz)	12	120	67,43	92,23	135,73
2200 136 01XX	Mek+Tuş Data Prizi 1*Rj45 (Cat5e)	12	120	254,19	371,66	386,17
2200 137 01XX	Mek+Tuş Data Prizi 2*Rj45 (Kon.süz)	12	120	81,90	103,86	147,24
2200 138 01XX	Mek+Tuş Data Prizi 2*Rj45 (Cat5e)	12	120	441,53	526,88	552,01
2200 139 01XX	Mek+Tuş Tlf Data Priz (Rj12 Cat3 + Cat5e)	12	120	301,15	487,83	508,97
2200 140 01XX	Mek+Tuş Data Prizi 1*Rj45 (Cat6)	12	120	239,78	374,73	385,47
2200 141 01XX	Mek+Tuş Data Prizi 2*Rj45 (Cat6)	12	120	443,00	575,74	615,83
2200 455 01XX	Mek+Tuş Data Prizi 1*Usb	12	120	319,59	346,86	392,34
2200 456 01XX	Mek+Tuş Data Prizi 2*Usb	12	120	564,41	608,01	710,56
2200 457 01XX	Mek+Tuş Data Prizi 1*Hdmı	12	120	439,61	452,25	497,27
2200 458 01XX	Mek+Tuş Data Prizi 2*Hdmı	12	120	793,21	831,60	866,31
2200 459 01XX	Mek+Tuş Data Prizi 1*Usb/1*Hdmı	12	120	680,91	698,06	746,51
2200 460 01XX	Mek+Tuş VGA Priz	12	120	644,63	1.039,01	1.112,30
2200 147 01XX	Mek+Tuş Bir Çıkışlı Fiber Optik Priz (RJ45)	12	120	220,13	291,48	320,19
2200 461 01XX	Mek+Tuş İki Çıkışlı Fiber Optik Priz	12	120	256,24	317,59	348,87
2200 121 02XX	Mek+Tuş Kör Kapak	12	120	59,44	125,76	135,05

### TV / SAT Grubu

2200 156 02XX	Mek+Tuş Tv-Sat Prizi (Geçişli) 4DB/F Kon.	12	120	506,67	596,22	763,33
2200 157 02XX	Mek+Tuş Tv-Sat Prizi (Sonlu)	12	120	506,67	596,22	763,33
2200 166 01XX	Mek+Tuş Sat Prizi (Geçişli) 4DB/F Kon.	12	120	446,61	514,94	579,17
2200 167 01XX	Mek+Tuş Sat Prizi (Sonlu)	12	120	446,61	514,94	579,17
2200 170 01XX	Mek+Tuş Tv Prizi (Geçişli) 11DB	12	120	159,50	212,44	262,72
2200 171 01XX	Mek+Tuş Tv Prizi (Sonlu)	12	120	159,50	212,44	262,72
2200 172 01XX	Mek+Tuş Tv Prizi F Dişi	12	120	108,12	117,56	125,07

### Çerçeveler

2220 800 11XX	Tekli Çerçeve	20	400	9,34	37,79	41,04
2220 800 12XX	İkili Yatay Çerçeve	10	200	48,38	74,09	84,12
2220 800 13XX	Üçlü Yatay Çerçeve	10	50	75,00	108,71	137,44
2220 800 14XX	Dörtlü Yatay Çerçeve	10	50	80,29	131,13	156,71
2220 800 15XX	Beşli Yatay Çerçeve	10	50	93,24	213,01	248,23
2220 800 16XX	Altılı Yatay Çerçeve	10	50	107,82	236,62	263,90
2220 800 22XX	İkili Dikey Çerçeve	10	50	48,38	74,09	84,12
2220 800 23XX	Üçlü Dikey Çerçeve	10	50	75,00	108,71	137,44
2220 800 24XX	Dörtlü Dikey Çerçeve	10	50	80,29	131,13	156,71
2220 800 25XX	Beşli Dikey Çerçeve	10	50	93,24	213,01	248,23
2220 800 26XX	Altılı Dikey Çerçeve	10	50	107,82	236,62	263,90
2220 820 12XX	İkili Priz Çerçeve	12	60	32,92	73,53	80,94
2100 000 11XX	Sıva Üstü Kasa	12	60	41,73	97,78	127,37
2200 000 11XX	Sıva Üstü Anahtar Kasası (Geçmeli)	-	-	69,41	163,47	187,21
2200 800 00XX	Telefon Tutucu	24	240	18,13	-	-
2200 000 0001	IP44 Kapaklı Priz Conta (Resmi Sayfa 30'da)	24	120	16,87	-	-

### RİTA PASTEL

#### Çerçeveler

2220 800 11XX	Tekli Çerçeve	20	400			16,48
2220 800 12XX	İkili Yatay Çerçeve	10	200			67,37
2220 800 13XX	Üçlü Yatay Çerçeve	10	50			110,87
2220 800 14XX	Dörtlü Yatay Çerçeve	10	50			138,58
2220 800 15XX	Beşli Yatay Çerçeve	10	50			152,68
2220 800 16XX	Altılı Yatay Çerçeve	10	50			174,50
2220 800 22XX	İkili Dikey Çerçeve	10	50			67,37
2220 800 23XX	Üçlü Dikey Çerçeve	10	50			110,87
2220 800 24XX	Dörtlü Dikey Çerçeve	10	50			138,58
2220 800 25XX	Beşli Dikey Çerçeve	10	50			152,68
2220 800 26XX	Altılı Dikey Çerçeve	10	50			174,50

Pastel Fiyat



Sıva üstü kasa uygulaması ile istediğiniz kadar "Anahtar Priz Uygulaması" yapabilirsiniz.



# Elitra | Plus

Uyum ve zarafet  
bir arada...



## Elitra | Plus

### Elitra Glass



XXX-811



XXX-814

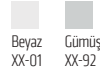

## BEYAZ / SİYAH

Kod	Ürün Tanımı	Kutu Adedi	Fiyat
2170 XXX 11XX	Tekli Çerçeve	10	510,85
2170 XXX 12XX	Yatay İkili Çerçeve	10	1.186,59
2170 XXX 13XX	Yatay Üçlü Çerçeve	10	1.974,53
2170 XXX 14XX	Yatay Dörtlü Çerçeve	10	2.417,04
2170 XXX 15XX	Yatay Beşli Çerçeve	10	3.583,70
2170 XXX 22XX	Dikey İkili Çerçeve	10	1.186,59
2170 XXX 23XX	Dikey Üçlü Çerçeve	10	1.974,53
2170 XXX 24XX	Dikey Dörtlü Çerçeve	10	2.417,04
2170 XXX 25XX	Dikey Beşli Çerçeve	10	3.583,70

## Elitra Chrome



XXX-821



XXX-822



XXX-824

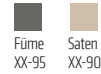

## KROM / PASLANMAZ ÇELİK / ALTIN

Kod	Ürün Tanımı	Kutu Adedi	Fiyat
2170 XXX 11XX	Tekli Çerçeve	10	1.025,38
2170 XXX 12XX	Yatay İkili Çerçeve	10	1.580,71
2170 XXX 13XX	Yatay Üçlü Çerçeve	10	2.130,89
2170 XXX 14XX	Yatay Dörtlü Çerçeve	10	2.344,70
2170 XXX 15XX	Yatay Beşli Çerçeve	10	3.034,19
2170 XXX 16XX	Yatay Altılı Çerçeve	10	4.050,23
2170 XXX 22XX	Dikey İkili Çerçeve	10	1.580,71
2170 XXX 23XX	Dikey Üçlü Çerçeve	10	2.130,89
2170 XXX 24XX	Dikey Dörtlü Çerçeve	10	2.344,70
2170 XXX 25XX	Dikey Beşli Çerçeve	10	3.034,19
2170 XXX 26XX	Dikey Altılı Çerçeve	10	4.050,23

## Elitra | Plus

### Elitra Chrome



XXX-825

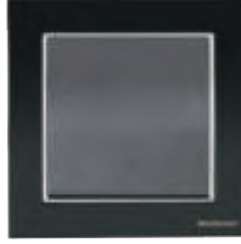

XXX-825



FÜME XX-95  
GÜMÜŞ XX-92

## GÜMÜŞ - PARLAK FÜME

Kod	Ürün Tanımı	Kutu Adedi	Fiyat
2170 825 11XX	Tekli Çerçeve	10	685,06
2170 825 12XX	Yatay İkili Çerçeve	10	1.207,36
2170 825 13XX	Yatay Üçlü Çerçeve	10	1.753,85
2170 825 14XX	Yatay Dörtlü Çerçeve	10	2.164,06
2170 825 15XX	Yatay Beşli Çerçeve	10	2.447,99
2170 825 16XX	Yatay Altılı Çerçeve	10	2.827,96
2170 825 22XX	Dikey İkili Çerçeve	10	1.207,36
2170 825 23XX	Dikey Üçlü Çerçeve	10	1.753,85
2170 825 24XX	Dikey Dörtlü Çerçeve	10	2.164,06
2170 825 25XX	Dikey Beşli Çerçeve	10	2.447,99
2170 825 26XX	Dikey Altılı Çerçeve	10	2.827,96

### Elitra Chrome

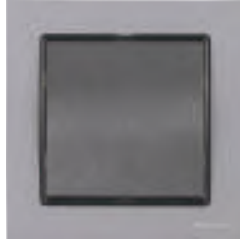

XXX-827



XXX-828



FÜME XX-95  
SATEN XX-90

## MAT ALÜMİNYUM - MAT SATEN

Kod	Ürün Tanımı	Kutu Adedi	Fiyat
2170 XXX 11XX	Tekli Çerçeve	10	636,07
2170 XXX 12XX	Yatay İkili Çerçeve	10	996,77
2170 XXX 13XX	Yatay Üçlü Çerçeve	10	1.349,47
2170 XXX 14XX	Yatay Dörtlü Çerçeve	10	1.639,27
2170 XXX 15XX	Yatay Beşli Çerçeve	10	2.089,89
2170 XXX 16XX	Yatay Altılı Çerçeve	10	2.819,48
2170 XXX 22XX	Dikey İkili Çerçeve	10	996,77
2170 XXX 23XX	Dikey Üçlü Çerçeve	10	1.349,47
2170 XXX 24XX	Dikey Dörtlü Çerçeve	10	1.639,27
2170 XXX 25XX	Dikey Beşli Çerçeve	10	2.089,89
2170 XXX 26XX	Dikey Altılı Çerçeve	10	2.819,48



## KAYIN / KIRAZ / VENGE

Kod	Ürün Tanımı	Kutu Adedi	Fiyat
2170 XXX 11XX	Tekli Çerçeve	10	621,66
2170 XXX 12XX	Yatay İkili Çerçeve	10	991,42
2170 XXX 13XX	Yatay Üçlü Çerçeve	10	1.435,52
2170 XXX 14XX	Yatay Dörtlü Çerçeve	10	1.876,85
2170 XXX 15XX	Yatay Beşli Çerçeve	10	2.309,18
2170 XXX 22XX	Dikey İkili Çerçeve	10	991,42
2170 XXX 23XX	Dikey Üçlü Çerçeve	10	1.435,52
2170 XXX 24XX	Dikey Dörtlü Çerçeve	10	1.876,85
2170 XXX 25XX	Dikey Beşli Çerçeve	10	2.309,18

## Elitra Marble

## BLACK QUARTZ / SAND STONE

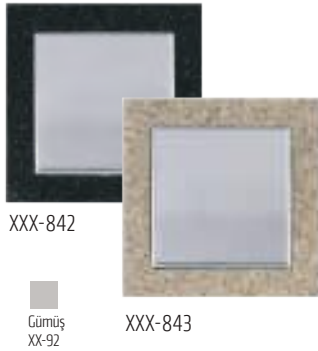

Kod	Ürün Tanımı	Kutu Adedi	Fiyat
2170 XXX 11XX	Tekli Çerçeve	10	773,93
2170 XXX 12XX	Yatay İkili Çerçeve	10	856,79
2170 XXX 13XX	Yatay Üçlü Çerçeve	10	1.321,23
2170 XXX 14XX	Yatay Dörtlü Çerçeve	10	1.725,86
2170 XXX 15XX	Yatay Beşli Çerçeve	10	2.123,90
2170 XXX 22XX	Dikey İkili Çerçeve	10	856,79
2170 XXX 23XX	Dikey Üçlü Çerçeve	10	1.321,23
2170 XXX 24XX	Dikey Dörtlü Çerçeve	10	1.725,86
2170 XXX 25XX	Dikey Beşli Çerçeve	10	2.123,90

## Elitra Ale

## NATURAL / SATEN / MAT FÜME



Kod	Ürün Tanımı	Kutu Adedi	Fiyat
2170 XXX 11XX	Tekli Çerçeve	10	498,96
2170 XXX 12XX	Yatay İkili Çerçeve	10	870,56
2170 XXX 13XX	Yatay Üçlü Çerçeve	10	1.397,92
2170 XXX 14XX	Yatay Dörtlü Çerçeve	10	1.784,41
2170 XXX 15XX	Yatay Beşli Çerçeve	10	2.181,59
2170 XXX 16XX	Yatay Altılı Çerçeve	10	4.078,73
2170 XXX 22XX	Dikey İkili Çerçeve	10	870,56
2170 XXX 23XX	Dikey Üçlü Çerçeve	10	1.397,92
2170 XXX 24XX	Dikey Dörtlü Çerçeve	10	1.784,41
2170 XXX 25XX	Dikey Beşli Çerçeve	10	2.181,59
2170 XXX 26XX	Dikey Altılı Çerçeve	10	4.078,73

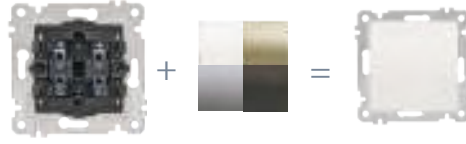

Kod	Ürün Tanımı	Kutu Adedi	Fiyat
<b>Anahtar Grubu Vidalı Tip</b>			
2270 401 02XX	Mek+Tuş Anahtar	12	90,14
2270 402 02XX	Mek+Tuş Komütatör	12	123,06
2270 403 02XX	Mek+Tuş Vavien (İki Yollu Anahtar)	12	114,76
2270 404 02XX	Mek+Tuş Komütatör Vavien	12	192,96
2270 405 02XX	Mek+Tuş Çift Kutuplu Anahtar	12	133,20
2270 406 02XX	Mek+Tuş Jaluzi Anahtarı-Yaylı	12	199,78
2270 407 02XX	Mek+Tuş Light (Çağırma)	12	126,90
2270 407 02XXZ	Mek+Tuş Zil Anahtarı	12	126,90
2270 407 02XXK	Mek+Tuş Kapı Otomatığı Anahtarı	12	126,90
2270 408 02XX	Mek+Tuş Deviyatör (Ara Vavien)	12	196,41
2270 409 02XX	Mek+Tuş Üçlü Anahtar	12	160,97
2270 411 02XX	Mek+Tuş Şöfben Anahtarı	12	194,36
2270 415 02XX	Mek+Tuş Işıklı Anahtar (220V)	12	170,13
2270 416 02XX	Mek+Tuş Işıklı Vavien (220V)	12	207,80
2270 417 02XX	Mek+Tuş Işıklı Çağırma (220V)	12	218,37
2270 418 02XX	Mek+Tuş Işıklı Etiketli Anahtar (220V)	12	170,70
2270 419 02XX	Mek+Tuş Işıklı Etiketli Çağırma (220V)	12	184,96
2270 422 02XX	Mek+Tuş Işıklı Zil Etiketli Çağırma (12V)	12	240,99
2270 426 02XX	Mek+Tuş Işıklı Komütatör	12	236,94
<b>Anahtar Grubu Klipsli Tip (Kolay Bağlantı)</b>			
2270 401 01XX	Mek+Tuş Anahtar	12	90,14
2270 402 01XX	Mek+Tuş Komütatör	12	123,06
2270 403 01XX	Mek+Tuş Vavien (İki Yollu Anahtar)	12	114,76
2270 404 01XX	Mek+Tuş Komütatör Vavien	12	192,96
2270 405 01XX	Mek+Tuş Çift Kutuplu Anahtar	12	133,20
2270 406 01XX	Mek+Tuş Jaluzi Anahtarı-Yaylı	12	199,78
2270 407 01XX	Mek+Tuş Light (Çağırma)	12	126,90
2270 407 01XXZ	Mek+Tuş Zil Anahtarı	12	126,90
2270 407 01XXK	Mek+Tuş Kapı Otomatığı Anahtarı	12	126,90
2270 408 01XX	Mek+Tuş Deviyatör (Ara Vavien)	12	196,41
2270 409 01XX	Mek+Tuş Üçlü Anahtar	12	160,97
2270 415 01XX	Mek+Tuş Işıklı Anahtar (220V)	12	170,13
2270 416 01XX	Mek+Tuş Işıklı Vavien (220V)	12	207,80
2270 417 01XX	Mek+Tuş Işıklı Çağırma (220V)	12	218,37
2270 418 01XX	Mek+Tuş Işıklı Etiketli Anahtar (220V)	12	170,70
2270 419 01XX	Mek+Tuş Işıklı Etiketli Çağırma (220V)	12	184,96
2270 422 01XX	Mek+Tuş Işıklı Zil Etiketli Çağırma (12V)	12	240,99
2270 426 01XX	Mek+Tuş Işıklı Komütatör	12	236,94
<b>Dimmer Grubu</b>			
2270 440 02XX	Mek+Tuş Işıklı Dimmer 600W	8	549,27
2270 444 02XX	Mek+Tuş Işıklı Dimmer 1000W	8	884,08
2270 447 02XX	Mek+Tuş RC Dimmer 325W	8	2.134,98
<b>Elektronik Grubu</b>			
2270 450 01XX	Mek+Tuş Energy Saver Gecikmesiz Işıklı	8	767,88
2270 452 01XX	Mek+Tuş Energy Saver Gecikmeli	8	795,06
2270 470 02XX	Mek+Tuş Müzik Yayın Anahtarı	8	956,25
2270 480 01XX	Mek+Tuş Hoparlör Prizi	8	302,97
2270 485 02XX	Mek+Tuş Uyarı Zili	8	1.249,80
2270 495 02XX	Mek+Tuş Hareket Sensörü	8	1.709,34
<b>Priz Grubu</b>			
2270 600 02XX	Mek+Tuş Topraklı Priz	12	139,84
2270 601 02XX	Mek+Tuş Topraksız Priz	12	117,68
2270 605 02XX	Mek+Tuş Topraklı Priz (Ç.K.)	12	142,21
2270 606 02XX	Mek+Tuş Topraksız Priz (Ç.K.)	12	122,17
2270 610 02XX	Mek+Tuş Kapaklı Topraklı Priz	12	150,81
2270 611 02XX	Mek+Tuş Kapaklı Topraklı Priz (Ç.K.)	12	174,34
2270 615 02XX	Mek+Tuş Ups (Fransız) Prizi	12	164,25
2270 616 02XX	Mek+Tuş Ups (Fransız) Prizi(Ç.K.)	12	216,84
2270 617 02XX	Mek+Tuş Ups Kapaklı (Fransız) Priz	12	206,09
2270 618 02XX	Mek+Tuş Ups Kap. (Fransız) Priz (Ç.K.)	12	211,53
2270 121 02XX	Mek+Tuş Kör Kapak	12	125,76
2270 448 01XX	Mek+Tuş Tekli Usb Şarj Prizi	5	550,14
2270 449 01XX	Mek+Tuş İkili Usb Şarj Prizi	5	629,02
<b>İletişim Grubu</b>			
2270 455 01XX	Mek+Tuş Data Prizi 1*Usb	12	346,86
2270 456 01XX	Mek+Tuş Data Prizi 2*Usb	12	608,01
2270 457 01XX	Mek+Tuş Data Prizi 1*Hdmi	12	452,25
2270 458 01XX	Mek+Tuş Data Prizi 2*Hdmi	12	831,60
2270 459 01XX	Mek+Tuş Data Prizi 1*Usb/1*Hdmi	12	698,06
2270 125 01XX	Mek+Tuş Telefon Prizi 1*Rj12 Cat3	12	166,11
2270 126 01XX	Mek+Tuş Telefon Prizi 2*Rj12 Cat3	12	239,05
2270 128 01XX	Mek+Tuş Etiketli Tlf+Data Priz (Kon.süz)	12	109,56
2270 135 01XX	Mek+Tuş Data Prizi 1*Rj45 (Kon.süz)	12	92,23
2270 136 01XX	Mek+Tuş Data Prizi 1*Rj45 (Cat5e)	12	371,66
2270 137 01XX	Mek+Tuş Data Prizi 2*Rj45 (Kon.süz)	12	103,86
2270 138 01XX	Mek+Tuş Data Prizi 2*Rj45 (Cat5e)	12	526,88
2270 139 01XX	Mek+Tuş Tlf+Data Priz (Rj12 Cat3+Cat5e)	12	487,83
2270 140 01XX	Mek+Tuş Data Prizi 1*Rj45 (Cat6)	12	374,73
2270 141 01XX	Mek+Tuş Data Prizi 2*Rj45 (Cat6)	12	575,74
<b>TV / SAT Grubu</b>			
2270 156 02XX	Mek+Tuş Tv-Sat Prizi (Geçişli) 4DB/F Kon.	12	596,22
2270 157 02XX	Mek+Tuş Tv-Sat Prizi (Sonlu)	12	596,22
2270 166 01XX	Mek+Tuş Sat Prizi (Geçişli) 4DB/F Konnektör	12	514,94
2270 167 01XX	Mek+Tuş Sat Prizi (Sonlu)	12	514,94
2270 170 01XX	Mek+Tuş Tv Prizi (Geçişli) 11DB	12	212,44
2270 171 01XX	Mek+Tuş Tv Prizi (Sonlu)	12	212,44
2270 172 01XX	Mek+Tuş Tv Prizi F Dişi	12	117,56



Beyaz  
 Saten  
 Gümüş  
 Füme  
 XX-01   XX-90   XX-92   XX-95

# Candelä

Şık Çözümler için...





**ANAHTAR GRUBU VIDALI TİP**

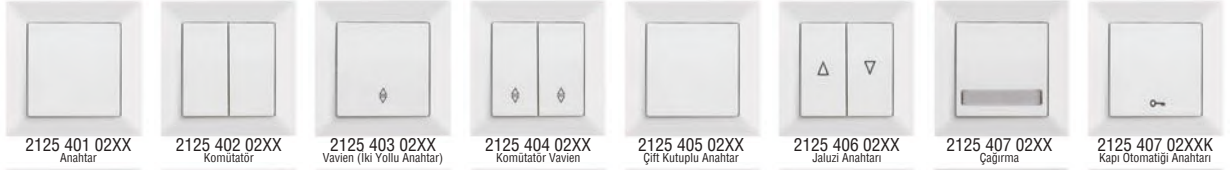

**ANAHTAR GRUBU KLİPSLİ TİP (KOLAY BAĞLANTI)**



**DİMMER GRUBU**

**ELEKTRONİK GRUBU**



**PRİZ GRUBU**



**İLETİŞİM GRUBU**

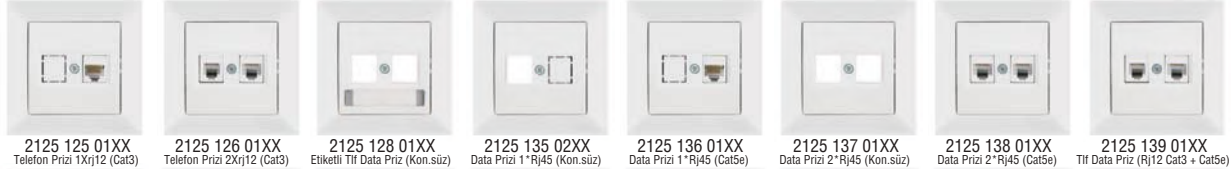

**TV / SAT GRUBU**

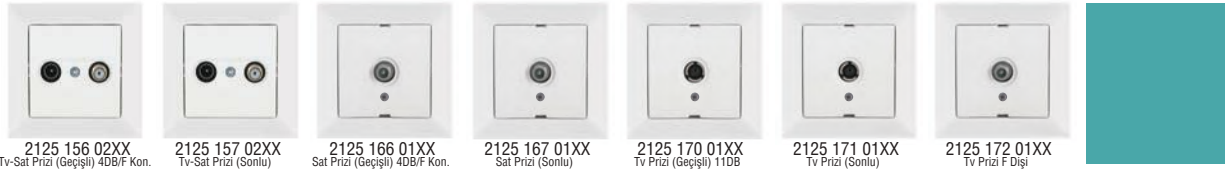

NATURAL



01 - BEYAZ



02 - KREM

AHŞAP



56 - KIRAZ



57 - CEVİZ



58 - MEŞE

METALİK



80 - A.ALTIN



82 - İNOX



83 - TİTANYUM



84 - SİYAH



85 - DORE



95 - FÜME



Kod	Ürün Tanımı	Kutu Adedi	Koli Adedi	Beyaz/Krem Fiyat	Metalik Fiyat	Ahşap Fiyat
-----	-------------	------------	------------	------------------	---------------	-------------

### Anahtar Grubu Vidalı Tip

2100 401 02XX	Mek+Tuş Anahtar (Vidalı)	12	120	75,81	90,14	120,17
2100 402 02XX	Mek+Tuş Komütatör (Vidalı)	12	120	101,46	123,06	138,87
2100 403 02XX	Mek+Tuş Vavien (İki Yollu Anahtar)(Vidalı)	12	120	100,61	114,76	133,68
2100 404 02XX	Mek+Tuş Komütatör Vavien (Vidalı)	12	120	174,12	192,96	205,54
2100 405 02XX	Mek+Tuş Çift Kutuplu Anahtar (Vidalı)	12	120	114,41	133,20	145,89
2100 406 02XX	Mek+Tuş Jaluzi Anahtarı (Vidalı)	12	120	143,74	199,78	214,45
2100 407 02XX	Mek+Tuş Çağırma (Vidalı)	12	120	85,00	126,90	131,85
2100 407 02XXK	Mek+Tuş Kapı Otomatiği Anahtarı (Vidalı)	12	120	85,00	126,90	131,85
2100 407 02XXZ	Mek+Tuş Zil Anahtarı (Vidalı)	12	120	85,00	126,90	131,85
2100 408 02XX	Mek+Tuş Deviatör(Ara Vavien)(Vidalı)	12	120	160,81	196,41	210,62
2100 409 02XX	Mek+Tuş Üçlü Anahtar (Vidalı)	12	120	132,80	160,97	212,55
2100 411 02XX	Mek+Tuş Sofben Anahtarı (Vidalı)	12	120	155,53	194,36	211,52
2100 415 02XX	Mek+Tuş Işıklı Anahtar (220V) (Vidalı)	12	120	141,59	170,13	182,97
2100 416 02XX	Mek+Tuş Işıklı Vavien (220V) (Vidalı)	12	120	180,89	207,80	268,64
2100 417 02XX	Mek+Tuş Işıklı Çağırma (220V) (Vidalı)	12	120	148,78	218,37	226,73
2100 418 02XX	Mek+Tuş Işıklı Etik. Anahtar (220V)(Vidalı)	12	120	163,12	170,70	195,83
2100 419 02XX	Mek+Tuş Işıklı Etik. Çağırma (220V)(Vidalı)	12	120	152,99	184,96	199,65
2100 422 02XX	Mek+Tuş Işıklı Zil Etik. Çağırma (12V)(Vidalı)	12	120	215,82	240,99	277,64
2100 426 02XX	Mek+Tuş Işıklı Komütatör (Vidalı)	12	120	192,34	236,94	251,40
2100 436 02XX	Mek+Tuş Jaluzi Anahtarı (Yaysız)(Vidalı)	12	120	157,89	205,33	226,70



### Anahtar Grubu Klipsli Tip (Kolay Bağlantı)

2100 401 01XX	Mek+Tuş Anahtar (Klipsli)	12	120	75,81	90,14	120,17
2100 402 01XX	Mek+Tuş Komütatör (Klipsli)	12	120	101,46	123,06	138,87
2100 403 01XX	Mek+Tuş Vavien (İki Yollu Anahtar)(Klipsli)	12	120	100,61	114,76	133,68
2100 404 01XX	Mek+Tuş Komütatör Vavien (Klipsli)	12	120	174,12	192,96	205,54
2100 405 01XX	Mek+Tuş Çift Kutuplu Anahtar (Klipsli)	12	120	114,41	133,20	145,89
2100 406 01XX	Mek+Tuş Jaluzi Anahtarı (Klipsli)	12	120	143,74	199,78	214,45
2100 407 01XX	Mek+Tuş Çağırma (Klipsli)	12	120	85,00	126,90	131,85
2100 407 01XXK	Mek+Tuş Kapı Otomatiği Anahtarı (Klipsli)	12	120	85,00	126,90	131,85
2100 407 01XXZ	Mek+Tuş Zil Anahtarı (Klipsli)	12	120	85,00	126,90	131,85
2100 408 01XX	Mek+Tuş Deviatör(Ara Vavien)(Klipsli)	12	120	160,81	196,41	210,62
2100 409 01XX	Mek+Tuş Üçlü Anahtar (Klipsli)	12	120	132,80	160,97	212,55
2100 415 01XX	Mek+Tuş Işıklı Anahtar (220V) (Klipsli)	12	120	141,59	170,13	182,97
2100 416 01XX	Mek+Tuş Işıklı Vavien (220V) (Klipsli)	12	120	180,89	207,80	268,64
2100 417 01XX	Mek+Tuş Işıklı Çağırma (220V)(Klipsli)	12	120	148,78	218,37	226,73
2100 418 01XX	Mek+Tuş Işıklı Etik. Anahtar (220V)(Klipsli)	12	120	163,12	170,70	195,83
2100 419 01XX	Mek+Tuş Işıklı Etik. Çağırma (220V)(Klipsli)	12	120	152,99	184,96	199,65
2100 422 01XX	Mek+Tuş Işıklı Zil Etik. Çağırma (12V)(Klipsli)	12	120	215,82	240,99	277,64
2100 426 01XX	Mek+Tuş Işıklı Komütatör (Vidalı)	12	120	192,34	236,94	251,40
2100 436 01XX	Mek+Tuş Jaluzi Anahtarı (Yaysız)(Klipsli)	12	120	157,89	205,33	224,94



### Dimmer Grubu

2100 440 02XX	Mek+Tuş RL Işıklı Dimmer 600W	8	80	448,67	549,27	681,87
2100 444 02XX	Mek+Tuş RL Işıklı Dimmer 1000W	8	80	570,87	884,08	964,37
2100 447 02XX	Mek+Tuş RC Dimmer 325W	8	80	1.180,73	2.134,98	2.339,33



### Elektronik Grubu

2100 450 01XX	Mek+Tuş Energy Saver G.siz Işıklı	8	80	671,08	767,88	823,09
2100 452 01XX	Mek+Tuş Energy Saver Gecikmeli Işıklı	8	80	697,69	795,06	834,18
2100 470 02XX	Mek+Tuş Müzik Yayın Anahtarı	8	80	911,16	956,25	1.009,68
2100 480 01XX	Mek+Tuş Hoparlör Prizi	8	80	193,34	302,97	336,29
2100 485 02XX	Mek+Tuş Uyarı Zili	8	80	1.168,06	1.249,80	1.281,54
2100 495 02XX	Mek+Tuş Hareket Sensörü	8	80	1.466,19	1.709,34	1.896,46

### Priz Grubu

2100 600 02XX	Mek+Tuş Topraklı Priz	12	120	97,80	139,84	158,47
2100 601 02XX	Mek+Tuş Topraksız Priz	12	120	84,48	117,68	147,51
2100 605 02XX	Mek+Tuş Topraklı Priz (Ç.K.)	12	120	119,09	142,21	230,09
2100 606 02XX	Mek+Tuş Topraksız Priz (Ç.K.)	12	120	95,47	122,17	171,99
2100 610 02XX	Mek+Tuş Kapaklı Topraklı Priz	12	120	126,78	150,81	169,86
2100 611 02XX	Mek+Tuş Kapaklı Topraklı Priz (Ç.K.)	12	120	135,28	174,34	202,25
2100 615 02XX	Mek+Tuş Ups (Fransız) Prizi	12	120	125,45	164,25	243,43
2100 616 02XX	Mek+Tuş Ups (Fransız) Prizi (Ç.K.)	12	120	179,27	216,84	242,28
2100 617 02XX	Mek+Tuş Ups Kapaklı (Fransız) Priz	12	120	133,79	206,09	234,01
2100 618 02XX	Mek+Tuş Ups Kapaklı (Fr.) Priz (Ç.K.)	12	120	190,30	211,53	239,46
2100 200 02XX	Mek+Tuş İkili Topraklı Priz Porselen	5	50	216,48	314,71	326,18
2100 201 02XX	Mek+Tuş İkili Topraksız Priz Porselen	5	50	163,79	215,06	254,91
2100 202 02XX	Mek+Tuş İkili Topraklı Priz	5	50	178,18	235,30	286,60
2100 203 02XX	Mek+Tuş İkili Topraksız Priz	5	50	142,90	188,48	232,76
2100 215 01XX	Mek+Tuş İkili Ups Priz	5	50	168,85	173,27	220,03
2100 448 01XX	Mek+Tuş Tekli Usb Şarj Prizi	5	50	453,74	550,14	602,20
2100 449 01XX	Mek+Tuş İkili Usb Şarj Prizi	5	50	575,28	629,02	754,16



Kod	Ürün Tanımı	Kutu Adedi	Koli Adedi	Beyaz/Krem Fiyat	Metalik Fiyat	Ahşap Fiyat
-----	-------------	------------	------------	------------------	---------------	-------------

### İletişim Grubu



2100 125 01XX	Mek+Tuş Telefon Prizi 1Xrj12 (Cat3)	12	120	108,83	166,11	191,45
2100 126 01XX	Mek+Tuş Telefon Prizi 2Xrj12 (Cat3)	12	120	180,81	239,05	246,13
2100 128 01XX	Mek+Tuş Etiketli Tlf Data Priz (Kon.süz)	12	120	88,27	109,56	132,41
2100 135 01XX	Mek+Tuş Data Prizi 1*Rj45 (Kon.süz)	12	120	67,43	92,23	135,73
2100 136 01XX	Mek+Tuş Data Prizi 1*Rj45 (Cat5e)	12	120	254,19	371,66	386,17
2100 137 01XX	Mek+Tuş Data Prizi 2*Rj45 (Kon.süz)	12	120	81,90	103,86	147,24
2100 138 01XX	Mek+Tuş Data Prizi 2*Rj45 (Cat5e)	12	120	441,53	526,88	552,01
2100 139 01XX	Mek+Tuş Tlf Data Priz (Rj12 Cat3 + Cat5e)	12	120	301,15	487,83	508,97
2100 140 01XX	Mek+Tuş Data Prizi 1*Rj45 (Cat6)	12	120	239,78	374,73	385,47
2100 141 01XX	Mek+Tuş Data Prizi 2*Rj45 (Cat6)	12	120	443,00	575,74	615,83
2100 455 01XX	Mek+Tuş Data Prizi 1*Usb	12	120	319,59	346,86	392,34
2100 456 01XX	Mek+Tuş Data Prizi 2*Usb	12	120	564,41	608,01	710,56
2100 457 01XX	Mek+Tuş Data Prizi 1*Hdmi	12	120	439,61	452,25	497,27
2100 458 01XX	Mek+Tuş Data Prizi 2*Hdmi	12	120	793,21	831,60	866,31
2100 459 01XX	Mek+Tuş Data Prizi 1*Usb/1*Hdmi	12	120	680,91	698,06	746,51
2100 460 01XX	Mek+Tuş VGA Priz	12	120	644,63	1.039,01	1.112,30
2100 121 02XX	Mek+Tuş Kõr Kapak	12	120	59,44	125,76	135,05

### TV / SAT Grubu



2100 156 02XX	Mek+Tuş Tv-Sat Prizi (Geçişli) 4DB/F Kon.	12	120	506,67	596,22	763,33
2100 157 02XX	Mek+Tuş Tv-Sat Prizi (Sonlu)	12	120	506,67	596,22	763,33
2100 166 01XX	Mek+Tuş Sat Prizi (Geçişli) 4DB/F Kon.	12	120	446,61	514,94	579,17
2100 167 01XX	Mek+Tuş Sat Prizi (Sonlu)	12	120	446,61	514,94	579,17
2100 170 01XX	Mek+Tuş Tv Prizi (Geçişli) 11DB	12	120	159,50	212,44	262,72
2100 171 01XX	Mek+Tuş Tv Prizi (Sonlu)	12	120	159,50	212,44	262,72
2100 172 01XX	Mek+Tuş Tv Prizi F Dişı	12	120	108,12	117,56	125,07

### Çerçeveler



2125 800 11XX	Tekli Çerçeve	20	400	9,34	37,79	41,04
2125 800 12XX	İkili Yatay Çerçeve	10	200	48,38	74,09	84,12
2125 800 13XX	Üçlü Yatay Çerçeve	10	50	75,00	108,71	137,44
2125 800 14XX	Dörtlü Yatay Çerçeve	10	50	80,29	131,13	156,71
2125 800 15XX	Beşli Yatay Çerçeve	10	50	93,24	213,01	248,23
2125 800 16XX	Altılı Yatay Çerçeve	10	50	107,82	236,62	263,90
2125 800 22XX	İkili Dikey Çerçeve	10	50	48,38	74,09	84,12
2125 800 23XX	Üçlü Dikey Çerçeve	10	50	75,00	108,71	137,44
2125 800 24XX	Dörtlü Dikey Çerçeve	10	50	80,29	131,13	156,71
2125 800 25XX	Beşli Dikey Çerçeve	10	50	93,24	213,01	248,23
2125 800 26XX	Altılı Dikey Çerçeve	10	50	107,82	236,62	263,90
2125 820 12XX	İkili Priz Çerçeve	12	60	32,92	73,53	80,94
2100 000 11XX	Sıva Üstü Kasa	12	60	41,73	97,78	127,37
2200 000 0001	IP44 Kapaklı Priz Conta (Resmi Sayfa 30'da)	24	120	16,87		

### İngiliz Tip

2190 500 0201	İngiliz Tipi Anahtarlı Priz Beyaz	12	120	205,33	-	-
---------------	-----------------------------------	----	-----	--------	---	---

# Candelä





SPEAKHONE

RCA

3,5 SES JAKI

XLR ERKEK

XLR DİŞİ

USB PRINTER

### RİTA MODÜLER SİSTEM

Kod	Ürün Tanımı	Kutu Adedi	Fiyat
2200 250 01XX	Mek+Tuş Speakhone Prizi	1	MÜŞTERİ TEMSİLCİSİNE FİYAT SORUNUZ
2200 251 01XX	Mek+Tuş RCA Prizi	1	
2200 252 01XX	Mek+Tuş 3,5 Ses Jaki	1	
2200 253 01XX	Mek+Tuş XLR Erkek Prizi	1	
2200 254 01XX	Mek+Tuş XLR Dişi Prizi	1	
2200 255 01XX	Mek+Tuş Usb Printer Prizi	1	



### ENERGY SAVER ÜRÜN LİSTESİ

Kod	Ürün Tanımı	Kutu Adedi	Fiyat
2110 052 0001	Energy Saver Kapak	1	
2100 012 01XX	Mek+Tuş Impuls Anahtar	12	
2100 023 01XX	Mek+Tuş Impuls Komütatör	12	
2100 024 01XX	Mek+Tuş Impuls Işıklı Anahtar (220V)	12	
2100 027 01XX	Mek+Tuş Impuls Işıklı Komütatör	12	
2125 010 0101	Otel Uyarı İç Ünitesi Komütatörü (Mekanik) Işıklı	12	
2220 010 0101	Rita Otel Uyarı İç Ünitesi Komütatörü (Mekanik) Işıklı	12	
2220 010 0201	Rita Otel Uyarı İç Ünitesi Komütatörü (Mekanik) Işıklı Vidalı	12	
2200 412 01XX	Rita Mek Tuş Impuls Anahtar (Klipsli)	12	
2200 412 02XX	Rita Mek Tuş Impuls Anahtar (Vidalı)	12	
2200 423 01XX	Rita Mek Tuş Impuls Komütatör (Klipsli)	12	
2200 423 02XX	Rita Mek Tuş Impuls Komütatör (Vidalı)	12	
2200 424 01XX	Rita Mek Tuş Impuls Işıklı Anahtar(Klipsli)	12	
2200 424 02XX	Rita Mek Tuş Impuls Işıklı Anahtar (Vidalı)	12	
2200 427 01XX	Rita Mek Tuş Impuls Işıklı Komütatör (Klipsli)	12	
2200 427 02XX	Rita Mek Tuş Impuls Işıklı Komütatör (Vidalı)	12	

# BRON

Sıva üstü uygulamalarda  
sorunsuz işlevsel çözümler...



### Sıva Üstü Anahtar Priz Serisi

#### Beyaz / Krem Ürün Listesi

## BRON Natural



■ Beyaz 01  
■ Krem 02

Kod	Ürün Tanımı	Kutu Adedi	Koli Adedi	Fiyat
2160 301 02XX	Bron S/Ü Anahtar	12	120	98,04
2160 302 02XX	Bron S/Ü Komütatör	12	120	117,62
2160 303 02XX	Bron S/Ü Vavien	12	120	119,02
2160 307 02XX	Bron S/Ü Light (Çağırma)	12	120	99,14
2160 315 02XX	Bron S/Ü Işıklı Anahtar (220V)	12	120	154,33
2160 316 02XX	Bron S/Ü Işıklı Vavien (220V)	12	120	169,11
2160 317 02XX	Bron S/Ü Işıklı Light (Çağırma) (220V)	12	120	157,80
2160 326 02XX	Bron S/Ü Işıklı Komütatör	12	120	154,86
2160 100 02XX	Bron S/Ü Topraklı Priz	12	120	122,32
2160 101 02XX	Bron S/Ü Topraksız Priz	12	120	115,44
2160 103 02XX	Bron S/Ü Topraklı Priz Porselen	12	120	153,58
2160 104 02XX	Bron S/Ü Topraksız Priz Porselen	12	120	113,72
2160 110 02XX	Bron S/Ü Kapaklı Topraklı Priz	10	100	135,94
2160 113 02XX	Bron S/Ü Kapaklı Topraklı Priz Porselen	10	100	157,65
2160 115 02XX	Bron S/Ü Ups (Fransız) Priz	12	120	120,17
2160 125 02XX	Bron S/Ü Telefon Prizi 1 *Rj12 Cat3	12	120	117,34
2160 136 02XX	Bron S/Ü Data Prizi 1 *Rj45 (Cat5)	12	120	129,48
2160 140 02XX	Bron S/Ü Data Prizi 1 *Rj45 (Cat6)	12	120	163,29
2160 166 02XX	Bron S/Ü Sat Prizi (Geçişli) 4Db/F Konnektör	12	120	292,11
2160 167 02XX	Bron S/Ü Sat Prizi (Sonlu)	12	120	292,11
2160 170 02XX	Bron S/Ü Tv Prizi (Geçişli)	12	120	246,89
2160 171 02XX	Bron S/Ü Tv Prizi (Sonlu)	12	120	246,89
2160 200 02XX	Bron S/Ü İkili Topraklı Priz Porselen	6	60	202,14
2160 201 02XX	Bron İkili Topraksız Priz Porselen	6	60	161,28
2160 202 02XX	Bron S/Ü İkili Topraklı Priz	6	60	185,21
2160 203 02XX	Bron S/Ü İkili Topraksız Priz	6	60	148,36
2160 215 02XX	Bron S/Ü İkili Ups (Fransız) Priz	6	60	153,38

### Sıva Üstü Anahtar Priz Serisi

#### Meşe / Ceviz Ürün Listesi

## BRON Ahşap



■ Meşe 58  
■ Ceviz 57

Kod	Ürün Tanımı	Kutu Adedi	Koli Adedi	Fiyat
2160 301 02XX	Bron S/Ü Anahtar	12	120	129,38
2160 302 02XX	Bron S/Ü Komütatör	12	120	150,19
2160 303 02XX	Bron S/Ü Vavien	12	120	153,87
2160 307 02XX	Bron S/Ü Light (Çağırma)	12	120	133,47
2160 315 02XX	Bron S/Ü Işıklı Anahtar (220V)	12	120	174,23
2160 316 02XX	Bron S/Ü Işıklı Vavien (220V)	12	120	189,11
2160 317 02XX	Bron S/Ü Işıklı Light (Çağırma) (220V)	12	120	177,56
2160 326 02XX	Bron S/Ü Işıklı Komütatör	12	120	192,51
2160 100 02XX	Bron S/Ü Topraklı Priz	12	120	183,75
2160 101 02XX	Bron S/Ü Topraksız Priz	12	120	140,32
2160 103 02XX	Bron S/Ü Topraklı Priz Porselen	12	120	173,50
2160 104 02XX	Bron S/Ü Topraksız Priz Porselen	12	120	144,33
2160 110 02XX	Bron S/Ü Kapaklı Topraklı Priz	10	100	178,25
2160 113 02XX	Bron S/Ü Kapaklı Topraklı Priz Porselen	10	100	199,96
2160 115 02XX	Bron S/Ü Ups (Fransız) Priz	12	120	150,82
2160 125 02XX	Bron S/Ü Telefon Prizi 1 *Rj12 Cat3	12	120	161,51
2160 136 02XX	Bron S/Ü Data Prizi 1 *Rj45 (Cat5)	12	120	228,66
2160 140 02XX	Bron S/Ü Data Prizi 1 *Rj45 (Cat6)	12	120	245,91
2160 166 02XX	Bron S/Ü Sat Prizi (Geçişli) 4Db/F Konnektör	12	120	327,39
2160 167 02XX	Bron S/Ü Sat Prizi (Sonlu)	12	120	327,39
2160 170 02XX	Bron S/Ü Tv Prizi (Geçişli)	12	120	275,06
2160 171 02XX	Bron S/Ü Tv Prizi (Sonlu)	12	120	275,06
2160 200 02XX	Bron S/Ü İkili Topraklı Priz Porselen	6	60	312,13
2160 201 02XX	Bron İkili Topraksız Priz Porselen	6	60	232,19
2160 202 02XX	Bron S/Ü İkili Topraklı Priz	6	60	308,95
2160 203 02XX	Bron S/Ü İkili Topraksız Priz	6	60	229,18
2160 215 02XX	Bron S/Ü İkili Ups (Fransız) Priz	6	60	353,77

# Nemliyer

Güvenliđi artırılmıř,  
sıva üstü anahtar serisi...



IP54



## Nemliyer Natural

### Beyaz / Gri Ürün Listesi

Kod	Ürün Tanımı	Kutu Adedi	Koli Adedi	Fiyat
2150 301 02XX	Anahtar Nemliyer	10	100	131,67
2150 302 02XX	Komütatör Nemliyer	10	100	157,57
2150 303 02XX	Vavien (İki Yollu Anahtar) Nemliyer	10	100	151,06
2150 305 02XX	Çift Kutuplu Anahtar Nemliyer	10	100	159,73
2150 307 02XX	Çağırma Nemliyer	10	100	131,09
2150 110 02XX	Kapaklı Topraklı Priz Nemliyer	8	80	161,57
2150 115 02XX	Ups Kapaklı Topraklı Priz Nemliyer	8	80	175,68
2150 125 02XX	Telefon Prizi 1*Rj12 Nemliyer	10	100	150,79
2150 136 01XX	Data Prizi 1*Rj45 (Cat5e) Nemliyer	10	100	168,46
2150 166 02XX	Sat Prizi (Geçişli) Nemliyer	10	100	242,78
2150 167 02XX	Sat Prizi (Sonlu) Nemliyer	10	100	242,78
2150 170 02XX	Tv Prizi (Geçişli) Nemliyer	10	100	216,00
2150 171 02XX	Tv Prizi (Sonlu) Nemliyer	10	100	216,00



Beyaz-01



Gri-03



## Nemliyer Ahşap

### Ahşap Ürün Listesi

Kod	Ürün Tanımı	Kutu Adedi	Koli Adedi	Fiyat
2150 301 02XX	Anahtar Nemliyer	10	100	167,17
2150 302 02XX	Komütatör Nemliyer	10	100	187,49
2150 303 02XX	Vavien (İki Yollu Anahtar) Nemliyer	10	100	184,66
2150 305 02XX	Çift Kutuplu Anahtar Nemliyer	10	100	200,00
2150 307 02XX	Çağırma Nemliyer	10	100	170,44
2150 110 02XX	Kapaklı Topraklı Priz Nemliyer	8	80	205,26
2150 115 02XX	Ups Kapaklı Topraklı Priz Nemliyer	8	80	220,59
2150 125 02XX	Telefon Prizi 1*Rj12 Nemliyer	10	100	168,74
2150 136 01XX	Data Prizi 1*Rj45 (Cat5e) Nemliyer	10	100	194,52
2150 166 02XX	Sat Prizi (Geçişli) Nemliyer	10	100	273,54
2150 167 02XX	Sat Prizi (Sonlu) Nemliyer	10	100	273,54
2150 170 02XX	Tv Prizi (Geçişli) Nemliyer	10	100	264,04
2150 171 02XX	Tv Prizi (Sonlu) Nemliyer	10	100	264,04



MUT-40  
AÇIK KAYIN



MUT-41  
KOYU CEVİZ



MUT-43  
MERBAU



MUT-44  
MAUN



MUT-49  
ARMUT

# Fiş Prizler Grup Prizler



Taşınabilir enerji ihtiyacınız için en kullanışlı seçenekler...



## Ri-tech Grup Prizler

Kod	Ürün Tanımı	Kutu Adedi	Fiyat
001 175 210001 00 00	İKİLİ TOP.LI GRUP PRİZ(Ç.K.)(KLEMENSLİ)	25	128,63
001 175 210002 01 00	İKİLİ TOP.LI GRUP PRİZ(Ç.K.)(1 MT)	12	249,68
001 175 210002 02 00	İKİLİ TOP.LI GRUP PRİZ(Ç.K.)(2 MT)	12	314,25
001 175 210002 03 00	İKİLİ TOP.LI GRUP PRİZ(Ç.K.)(3 MT)	12	378,80
001 175 210002 05 00	İKİLİ TOP.LI GRUP PRİZ(Ç.K.)(5 MT)	12	532,56
001 175 220001 00 00	İKİLİ ANAHT. TOP.LI GRUP PRİZ(Ç.K.)(KLEMENSLİ)	25	274,53
001 175 220002 01 00	İKİLİ ANAHT. TOP.LI GRUP PRİZ(Ç.K.)(1 MT)	12	397,89
001 175 220002 02 00	İKİLİ ANAHT. TOP.LI GRUP PRİZ(Ç.K.)(2 MT)	12	462,46
001 175 220002 03 00	İKİLİ ANAHT. TOP.LI GRUP PRİZ(Ç.K.)(3 MT)	12	527,02
001 175 220002 05 00	İKİLİ ANAHT. TOP.LI GRUP PRİZ(Ç.K.)(5 MT)	12	657,25
001 175 310001 00 00	ÜÇLÜ TOP.LI GRUP PRİZ(Ç.K.)(KLEMENSLİ)	25	166,41
001 175 310002 01 00	ÜÇLÜ TOP.LI GRUP PRİZ(Ç.K.)(1 MT)	12	276,53
001 175 310002 02 00	ÜÇLÜ TOP.LI GRUP PRİZ(Ç.K.)(2 MT)	12	341,10
001 175 310002 03 00	ÜÇLÜ TOP.LI GRUP PRİZ(Ç.K.)(3 MT)	12	405,72
001 175 310002 05 00	ÜÇLÜ TOP.LI GRUP PRİZ(Ç.K.)(5 MT)	12	535,48
001 175 320001 00 00	ÜÇLÜ ANAHT. TOP.LI GRUP PRİZ(Ç.K.)(KLEMENSLİ)	25	324,37
001 175 320002 01 00	ÜÇLÜ ANAHT. TOP.LI GRUP PRİZ(Ç.K.)(1 MT)	12	439,21
001 175 320002 02 00	ÜÇLÜ ANAHT. TOP.LI GRUP PRİZ(Ç.K.)(2 MT)	12	501,16
001 175 320002 03 00	ÜÇLÜ ANAHT. TOP.LI GRUP PRİZ(Ç.K.)(3 MT)	12	566,09
001 175 320002 05 00	ÜÇLÜ ANAHT. TOP.LI GRUP PRİZ(Ç.K.)(5 MT)	12	695,29
001 175 350001 00 00	ÜÇLÜ USB ANAHT. TOP.LI GRUP PRİZ(Ç.K.)(KLEMENSLİ)	25	701,42
001 175 350002 02 00	ÜÇLÜ USB ANAHT. TOP.LI GRUP PRİZ(Ç.K.)(2 MT)	12	949,70
001 175 350002 03 00	ÜÇLÜ USB ANAHT. TOP.LI GRUP PRİZ(Ç.K.)(3 MT)	12	1.032,70
001 175 350002 05 00	ÜÇLÜ USB ANAHT. TOP.LI GRUP PRİZ(Ç.K.)(5 MT)	12	1.218,36
001 175 410001 00 00	DÖRTLÜ TOP.LI GRUP PRİZ(Ç.K.)(KLEMENSLİ)	25	207,27
001 175 410002 01 00	DÖRTLÜ TOP.LI GRUP PRİZ(Ç.K.)(1 MT)	12	317,51
001 175 410002 02 00	DÖRTLÜ TOP.LI GRUP PRİZ(Ç.K.)(2 MT)	12	378,38
001 175 410002 03 00	DÖRTLÜ TOP.LI GRUP PRİZ(Ç.K.)(3 MT)	12	452,30
001 175 410002 05 00	DÖRTLÜ TOP.LI GRUP PRİZ(Ç.K.)(5 MT)	12	578,02
001 175 420001 00 00	DÖRTLÜ ANAHT. TOP.LI GRUP PRİZ(Ç.K.)(KLEMENSLİ)	25	395,03
001 175 420002 01 00	DÖRTLÜ ANAHT. TOP.LI GRUP PRİZ(Ç.K.)(1 MT)	12	488,58
001 175 420002 02 00	DÖRTLÜ ANAHT. TOP.LI GRUP PRİZ(Ç.K.)(2 MT)	12	546,20
001 175 420002 03 00	DÖRTLÜ ANAHT. TOP.LI GRUP PRİZ(Ç.K.)(3 MT)	12	626,33
001 175 420002 05 00	DÖRTLÜ ANAHT. TOP.LI GRUP PRİZ(Ç.K.)(5 MT)	12	740,91
001 175 610001 00 00	ALTILI TOP.LI GRUP PRİZ(Ç.K.)(KLEMENSLİ)	25	282,40
001 175 610002 01 00	ALTILI TOP.LI GRUP PRİZ(Ç.K.)(1 MT)	12	404,40
001 175 610002 02 00	ALTILI TOP.LI GRUP PRİZ(Ç.K.)(2 MT)	12	527,59
001 175 610002 03 00	ALTILI TOP.LI GRUP PRİZ(Ç.K.)(3 MT)	12	627,91
001 175 610002 05 00	ALTILI TOP.LI GRUP PRİZ(Ç.K.)(5 MT)	12	815,96
001 175 620001 00 00	ALTILI ANAHT. TOP.LI GRUP PRİZ(Ç.K.)(KLEMENSLİ)	25	493,30
001 175 620002 01 00	ALTILI ANAHT. TOP.LI GRUP PRİZ(Ç.K.)(1 MT)	12	593,21
001 175 620002 02 00	ALTILI ANAHT. TOP.LI GRUP PRİZ(Ç.K.)(2 MT)	12	680,27
001 175 620002 03 00	ALTILI ANAHT. TOP.LI GRUP PRİZ(Ç.K.)(3 MT)	12	772,66
001 175 620002 05 00	ALTILI ANAHT. TOP.LI GRUP PRİZ(Ç.K.)(5 MT)	12	981,10
001 175 650001 00 00	ALTILI USB ANAHT. TOP.LI GRUP PRİZ(Ç.K.)(KLEMENSLİ)	25	771,18
001 175 650002 02 00	ALTILI USB ANAHT. TOP.LI GRUP PRİZ(Ç.K.)(2 MT)	12	1.121,98
001 175 650002 03 00	ALTILI USB ANAHT. TOP.LI GRUP PRİZ(Ç.K.)(3 MT)	12	1.235,10
001 175 650002 05 00	ALTILI USB ANAHT. TOP.LI GRUP PRİZ(Ç.K.)(5 MT)	12	1.423,38



## Ri-tech Grup Prizler



ALTI LI ŞOK KORUMALI USB ANAHT. TOPRAKLI GRUP PRİZ



2'Lİ USB ŞARJ ADAPTÖR



TEKLİ ŞOK KORUMALI PRİZ



USB+TYPE-C TOPRAKLI PRİZ



2'Lİ USB TOPRAKLI PRİZ



Kod	Ürün Tanımı	Kutu Adedi	Fiyat
001 175 330001 00 00	ÜÇLÜ UPS GRUP PRİZ(Ç.K.)(KLEMENSLİ)	25	198,10
001 175 330002 02 00	ÜÇLÜ UPS GRUP PRİZ(Ç.K.)(2 MT)	12	435,61
001 175 330002 03 00	ÜÇLÜ UPS GRUP PRİZ(Ç.K.)(3 MT)	12	517,95
001 175 330002 05 00	ÜÇLÜ UPS GRUP PRİZ(Ç.K.)(5 MT)	12	674,22
001 175 340001 00 00	ÜÇLÜ ANAHT. UPS GRUP PRİZ(Ç.K.)(KLEMENSLİ)	25	348,29
001 175 340002 02 00	ÜÇLÜ ANAHT. UPS GRUP PRİZ(Ç.K.)(2 MT)	12	509,19
001 175 340002 03 00	ÜÇLÜ ANAHT. UPS GRUP PRİZ(Ç.K.)(3 MT)	12	616,44
001 175 340002 05 00	ÜÇLÜ ANAHT. UPS GRUP PRİZ(Ç.K.)(5 MT)	12	763,95
001 175 430001 00 00	DÖRTLÜ UPS GRUP PRİZ(Ç.K.)(KLEMENSLİ)	25	291,91
001 175 430002 02 00	DÖRTLÜ UPS GRUP PRİZ(Ç.K.)(2 MT)	12	544,01
001 175 430002 03 00	DÖRTLÜ UPS GRUP PRİZ(Ç.K.)(3 MT)	12	619,56
001 175 430002 05 00	DÖRTLÜ UPS GRUP PRİZ(Ç.K.)(5 MT)	12	854,74
001 175 440001 00 00	DÖRTLÜ ANAHT. UPS GRUP PRİZ(Ç.K.)(KLEMENSLİ)	25	461,96
001 175 440002 02 00	DÖRTLÜ ANAHT. UPS GRUP PRİZ(Ç.K.)(2 MT)	12	761,59
001 175 440002 03 00	DÖRTLÜ ANAHT. UPS GRUP PRİZ(Ç.K.)(3 MT)	12	825,22
001 175 440002 05 00	DÖRTLÜ ANAHT. UPS GRUP PRİZ(Ç.K.)(5 MT)	12	1.074,64
001 175 630001 00 00	ALTI LI UPS GRUP PRİZ(Ç.K.)(KLEMENSLİ)	25	402,12
001 175 630002 02 00	ALTI LI UPS GRUP PRİZ(Ç.K.)(2 MT)	12	711,49
001 175 630002 03 00	ALTI LI UPS GRUP PRİZ(Ç.K.)(3 MT)	12	923,01
001 175 630002 05 00	ALTI LI UPS GRUP PRİZ(Ç.K.)(5 MT)	12	1.183,52
001 175 640001 00 00	ALTI LI ANAHT. UPS GRUP PRİZ(Ç.K.)(KLEMENSLİ)	25	588,65
001 175 640002 02 00	ALTI LI ANAHT. UPS GRUP PRİZ(Ç.K.)(2 MT)	12	895,22
001 175 640002 03 00	ALTI LI ANAHT. UPS GRUP PRİZ(Ç.K.)(3 MT)	12	1.014,55
001 175 640002 05 00	ALTI LI ANAHT. UPS GRUP PRİZ(Ç.K.)(5 MT)	12	1.344,07

## Ri-tech Akım (Şok) Korumalı Grup Priz

Kod	Ürün Tanımı	Kutu Adedi	Fiyat
001 175 660002 15 00	ALTI LI ŞOK.KOR. USB ANAHT. TOP.LI GRUP PRİZ(Ç.K.) (3X1.5 1.5 MT)	12	1.660,59
001 175 670002 15 00	ALTI LI ŞOK.KOR. ANAHT. TOP.LI GRUP PRİZ(Ç.K.) (3X1.5 1.5 MT)	12	1.298,12

## Ri-tech USB Şarj

Kod	Ürün Tanımı	Kutu Adedi	Fiyat
001 888 100002 00 00	2'Li USB ŞARJ ADAPTÖR 2,4A	20	296,49
001 888 100004 00 00	TEKLİ ŞOK KORUMALI PRİZ	12	537,78

Kod	Ürün Tanımı	Kutu Adedi	Koli Adedi	Beyaz/Krem Fiyat	Metalik Fiyat	Ahşap Fiyat
2220 619 02XX	İKİLİ USB TOPRAKLI PRİZ (ÇERÇEVE DAHİL)	8	-	590,43	1.022,28	1.078,90
2220 629 02XX	USB +TYPE-C Lİ TOPRAKLI PRİZ (ÇERÇEVE DAHİL)	8	-	696,71	1.052,94	1.140,18

YENİ

## Olimpia Grup Prizler

### Ürün Listesi

Kod	Ürün Tanımı	Kutu Adedi	Fiyat
001 171 290001 00 00	İkili Topraksız Grup Priz (Klemensli) Olimpia	25	88,90
001 171 290002 02 00	İkili Topraksız Grup Priz (2Mt) Olimpia	12	229,47
001 171 290002 03 00	İkili Topraksız Grup Priz (3Mt) Olimpia	12	270,53
001 171 290002 05 00	İkili Topraksız Grup Priz (5Mt) Olimpia	12	351,08
001 171 210001 00 00	İkili Topraklı Grup Priz (Klemensli) Olimpia	25	122,20
001 171 210002 02 00	İkili Topraklı Grup Priz (2Mt) Olimpia	12	298,54
001 171 210002 03 00	İkili Topraklı Grup Priz (3M) Olimpia	12	359,86
001 171 210002 05 00	İkili Topraklı Grup Priz (5M) Olimpia	12	505,93
001 171 390001 00 00	Üçlü Topraksız Grup Priz (Klemensli) Olimpia	25	133,12
001 171 390002 02 00	Üçlü Topraksız Grup Priz (2Mt) Olimpia	12	270,18
001 171 390002 03 00	Üçlü Topraksız Grup Priz(3Mt) Olimpia	12	311,30
001 171 390002 05 00	Üçlü Topraksız Grup Priz (5Mt) Olimpia	12	396,71
001 171 310001 00 00	Üçlü Grup Priz Topraklı (Klemensli) Olimpia	25	158,09
001 171 310002 02 00	Üçlü Topraklı Grup Priz (2Mt) Olimpia	12	324,05
001 171 310002 03 00	Üçlü Topraklı Grup Priz (3Mt) Olimpia	12	385,43
001 171 310002 05 00	Üçlü Topraklı Grup Priz (5Mt) Olimpia	12	508,70
001 171 320001 00 00	Üçlü Topraklı Grup Priz (Klemensli Anahtarlı) Olimpia	25	308,16
001 171 320002 02 00	Üçlü Topraklı Grup Priz (Anahtarlı 2 Mt) Olimpia	12	476,11
001 171 320002 03 00	Üçlü Topraklı Grup Priz (Anahtarlı 3 Mt) Olimpia	12	537,79
001 171 320002 05 00	Üçlü Topraklı Grup Priz (Anahtarlı 5 Mt) Olimpia	12	660,53
001 171 340001 00 00	Üçlü Ups Grup Priz (Klemensli) Olimpia	25	330,87
001 171 330001 02 00	Üçlü Ups Grup Priz (2Mt) Olimpia	12	413,83
001 171 330001 03 00	Üçlü Ups Grup Priz (3Mt) Olimpia	12	492,05
001 171 330001 05 00	Üçlü Ups Grup Priz (5Mt) Olimpia	12	640,51
001 171 410001 00 00	Dörtlü Topraklı Grup Priz (Klemensli) Olimpia	25	196,91
001 171 410001 02 00	Dörtlü Topraklı Grup Priz (2Mt) Olimpia	12	359,46
001 171 410001 03 00	Dörtlü Topraklı Grup Priz (3Mt) Olimpia	12	429,69
001 171 410001 05 00	Dörtlü Topraklı Grup Priz (5Mt) Olimpia	12	549,12
001 171 410002 00 00	Dörtlü Topraklı Grup Priz (Klemensli-Anah. Olimpia)	25	375,28
001 171 410002 02 00	Dörtlü Topraklı Grup Priz (Anahtarlı 2 Mt) Olimpia	12	518,89
001 171 410002 03 00	Dörtlü Topraklı Grup Priz (Anahtarlı 3 Mt) Olimpia	12	595,02
001 171 410002 05 00	Dörtlü Topraklı Grup Priz (Anahtarlı 5 Mt) Olimpia	12	703,87
001 171 610001 00 00	Altılı Grup Priz Top.lı (Klemensli) Olimpia	25	268,28
001 171 610001 02 00	Altılı Topraklı Grup Priz (2 Mt) Olimpia	12	501,21
001 171 610001 03 00	Altılı Topraklı Grup Priz (3 Mt) Olimpia	12	596,51
001 171 610001 05 00	Altılı Topraklı Grup Priz (5 Mt) Olimpia	12	775,16
001 171 610002 00 00	Altılı Topraklı Grup Priz (Klemensli-Anahtarlı) Olimpia	25	468,63
001 171 610002 02 00	Altılı Topraklı Grup Priz (Anahtarlı 2 Mt) Olimpia	12	646,25
001 171 610002 03 00	Altılı Topraklı Grup Priz (Anahtarlı 3 Mt) Olimpia	12	734,03
001 171 610002 05 00	Altılı Topraklı Grup Priz (Anahtarlı 5 Mt) Olimpia	12	932,05
001 170 110001 00 00	10'lu Topraklı Grup Priz (Klemensli)	20	737,76



## Fiş Prizler

### Ürün Listesi



CE

Ürün Kodu	001 170 012001 00 00
Ürün Adı	Topraklı Erkek Fiş (Kuyruklu)
Kutu Adedi	50
Fiyatı	72,22 ₺



CE

Ürün Kodu	001 170 010001 00 00
Ürün Adı	Erkek Fiş
Kutu Adedi	50
Fiyatı	55,56 ₺



CE

Ürün Kodu	001 170 013001 00 00
Ürün Adı	Topraklı Erkek Fiş Ups (Kuyruklu)
Kutu Adedi	50
Fiyatı	77,78 ₺



CE

Ürün Kodu	001 170 020001 00 00
Ürün Adı	Dişi Fiş
Kutu Adedi	50
Fiyatı	38,61 ₺



CE

Ürün Kodu	001 170 011001 00 00
Ürün Adı	Topraklı Erkek Fiş
Kutu Adedi	50
Fiyatı	69,44 ₺



CE

Ürün Kodu	001 170 021001 00 00
Ürün Adı	Topraklı Dişi Fiş
Kutu Adedi	25
Fiyatı	63,91 ₺



CE

Ürün Kodu	001 170 014001 00 00
Ürün Adı	Topraklı Erkek Fiş Ups
Kutu Adedi	50
Fiyatı	75,00 ₺



CE

Ürün Kodu	001 170 011002 00 00
Ürün Adı	Kulplu Topraklı Erkek Fiş
Kutu Adedi	50
Fiyatı	69,58 ₺



CE

Ürün Kodu	001 170 051001 00 00
Ürün Adı	Topraklı Erkek Fiş
Kutu Adedi	50/600
Fiyatı	67,47 ₺



CE

Ürün Kodu	001 170 061001 00 00
Ürün Adı	Topraklı Dişi Fiş
Kutu Adedi	25/600
Fiyatı	75,90 ₺



Ürün Kodu	001 170 050001 00 00
Ürün Adı	Erkek Fiş
Kutu Adedi	50/600
Fiyatı	46,38 ₺



CE

Ürün Kodu	001 170 060001 00 00
Ürün Adı	Dişi Fiş
Kutu Adedi	50/600
Fiyatı	33,73 ₺

## Fiş Prizler

### Ürün Listesi



CE

Ürün Kodu	001 170 033001 00 00
Ürün Adı	Topraklı Üçlü Fiş-Priz (Yonca Tip) (S/A)
Kutu Adedi	12/144
Fiyatı	265,65 ₺



Ürün Kodu	001 888 000001 00 00
Ürün Adı	Prizmatik Priz Koruma Kapağı
Kutu Adedi	100
Fiyatı	31,11 ₺



CE

Ürün Kodu	001 170 033002 00 00
Ürün Adı	Topraklı Üçlü Fiş-Priz (Yonca Tip) (S/Ü)
Kutu Adedi	20/240
Fiyatı	259,33 ₺



CE

Ürün Kodu	001 170 033003 00 00
Ürün Adı	İkili Topraklı Fiş-Priz (Düz Tip)
Kutu Adedi	24
Fiyatı	250,89 ₺



Ürün Kodu	001 170 030002 00 00
Ürün Adı	Adaptör Fiş, Priz (İngiliz Tip)
Kutu Adedi	50/500
Fiyatı	3,06 \$



CE

Ürün Kodu	001 170 033005 00 00
Ürün Adı	Üçlü Topraklı Fiş-Priz (Düz Tip)
Kutu Adedi	24
Fiyatı	303,60 ₺



CE

Ürün Kodu	001 170 030001 00 00
Ürün Adı	Arapuar Anahtar
Kutu Adedi	50/600
Fiyatı	36,90 ₺



CE

Ürün Kodu	001 170 033004 00 00
Ürün Adı	Üçlü Topraklı Fiş-Priz (Düz Tip Anahtarlı)
Kutu Adedi	24
Fiyatı	415,34 ₺



CE

Ürün Kodu	001 170 033006 00 00
Ürün Adı	İkili Topraklı Fiş-Priz (Düz Tip Beyaz)
Kutu Adedi	28
Fiyatı	130,01 ₺



CE

Ürün Kodu	001 170 033007 00 00
Ürün Adı	İkili Topraklı Fiş-Priz (Düz Tip Beyaz Anahtarlı)
Kutu Adedi	28
Fiyatı	238,94 ₺

Korumasız  
Prizlerinizin  
Çözümü



IP44  
Kapaklı Priz Conta ile  
Daha Güvende..

## Fiş Prizler

### Ürün Listesi



CE

Ürün Kodu	001 170 011002 00 11
Ürün Adı	Kulplu Topraklı Erkek Fiş Siyah
Kutu Adedi	50
Fiyatı	69,58 ₺



CE

Ürün Kodu	001 170 050001 00 11
Ürün Adı	Erkek Fiş Siyah
Kutu Adedi	50
Fiyatı	46,38 ₺



CE

Ürün Kodu	001 170 051001 00 11
Ürün Adı	Topraklı Erkek Fiş Siyah
Kutu Adedi	50
Fiyatı	67,47 ₺



CE

Ürün Kodu	001 170 060001 00 11
Ürün Adı	Dişi Fiş Siyah
Kutu Adedi	50
Fiyatı	33,73 ₺



CE

Ürün Kodu	001 170 061001 00 11
Ürün Adı	Topraklı Dişi Fiş Siyah
Kutu Adedi	25
Fiyatı	75,90 ₺



CE

Ürün Kodu	001 170 030001 00 11
Ürün Adı	Arapuar Anahtar Siyah
Kutu Adedi	50
Fiyatı	36,90 ₺



CE

Ürün Kodu	001 170 033002 00 11
Ürün Adı	Topraklı Üçlü Fiş-Priz (Yonca Tip) (S/Ü) Siyah
Kutu Adedi	20
Fiyatı	259,33 ₺



CE

Ürün Kodu	001 170 033003 00 11
Ürün Adı	İkili Topraklı Fiş-Priz Düz Tip Siyah
Kutu Adedi	24
Fiyatı	250,89 ₺



CE

Ürün Kodu	001 170 033005 00 11
Ürün Adı	Üçlü Topraklı Fiş-Priz (Düz Tip) Siyah
Kutu Adedi	24
Fiyatı	303,60 ₺



CE

Ürün Kodu	001 170 033004 00 11
Ürün Adı	Üçlü Topraklı Anahtarlı Fiş-Priz (Düz Tip) Siyah
Kutu Adedi	24
Fiyatı	415,34 ₺



CE

Ürün Kodu	001 170 033006 00 11
Ürün Adı	İkili Topraklı Fiş-Priz (Düz Tip Siyah)
Kutu Adedi	28
Fiyatı	130,01 ₺



CE

Ürün Kodu	001 170 033007 00 11
Ürün Adı	İkili Topraklı Fiş-Priz (Düz Tip Siyah Anahtarlı)
Kutu Adedi	28
Fiyatı	238,94 ₺



CE

Ürün Kodu	001 170 030002 00 11
Ürün Adı	Adaptör Fiş, Priz (İngiliz Tip) Siyah
Kutu Adedi	50
Fiyatı	3,06 \$





KABLO KANALLARI, PLASTİK GRUBU,  
TESİSAT GRUBU ve  
AYDINLATMA GRUBU

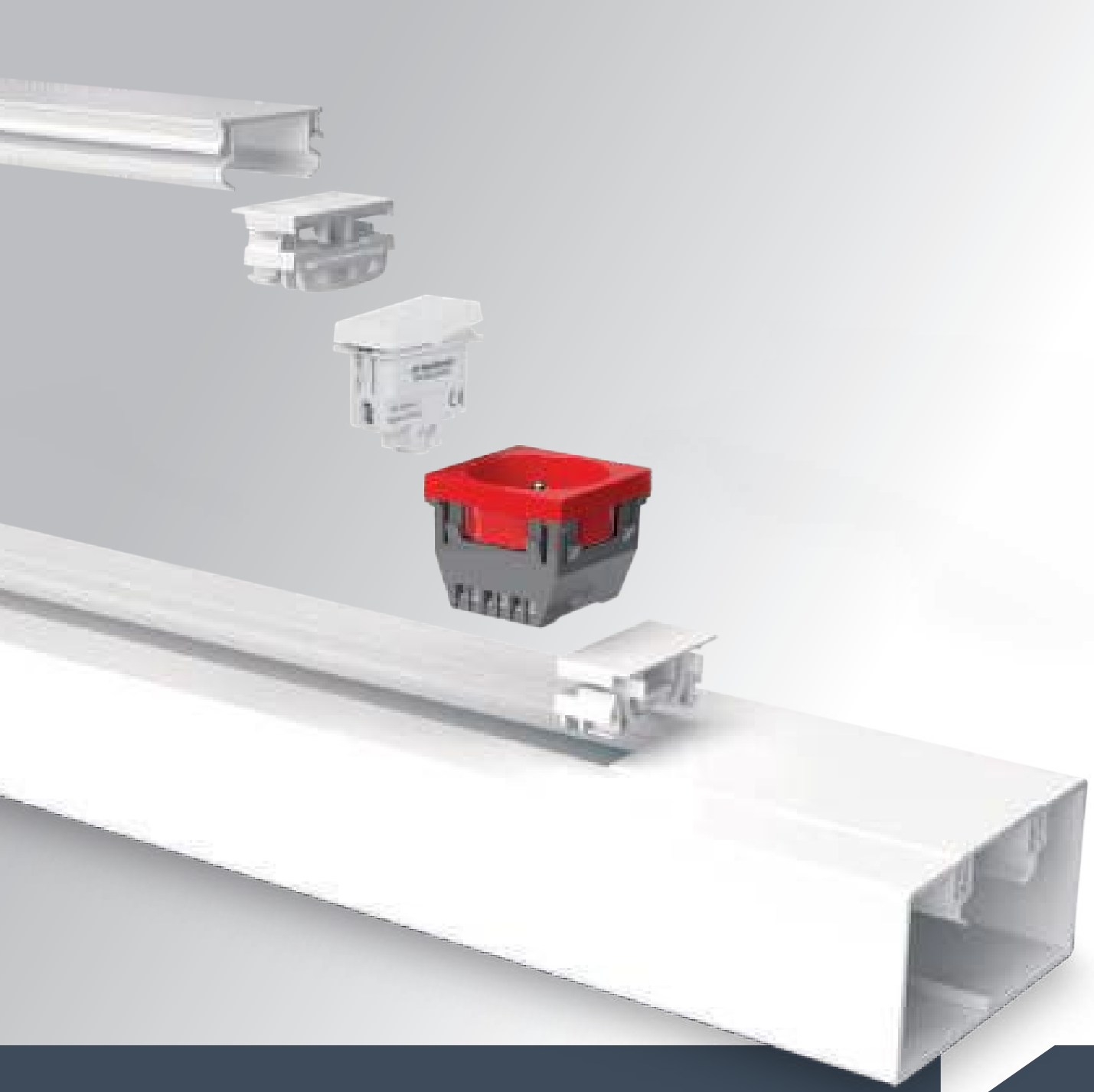

UÇ TAPA



T KÖŞE



İÇ KÖŞE



EK PARÇA



DIŞ KÖŞE



L KÖŞE

*KABLO KANALLARI ve AKSESUARLARI*

# YENİ PRİZ MONTAJ SETLERİMİZ YENİ TIRNAK YAPISI İLE DAHA SAĞLAM DAHA GÜVENLİ

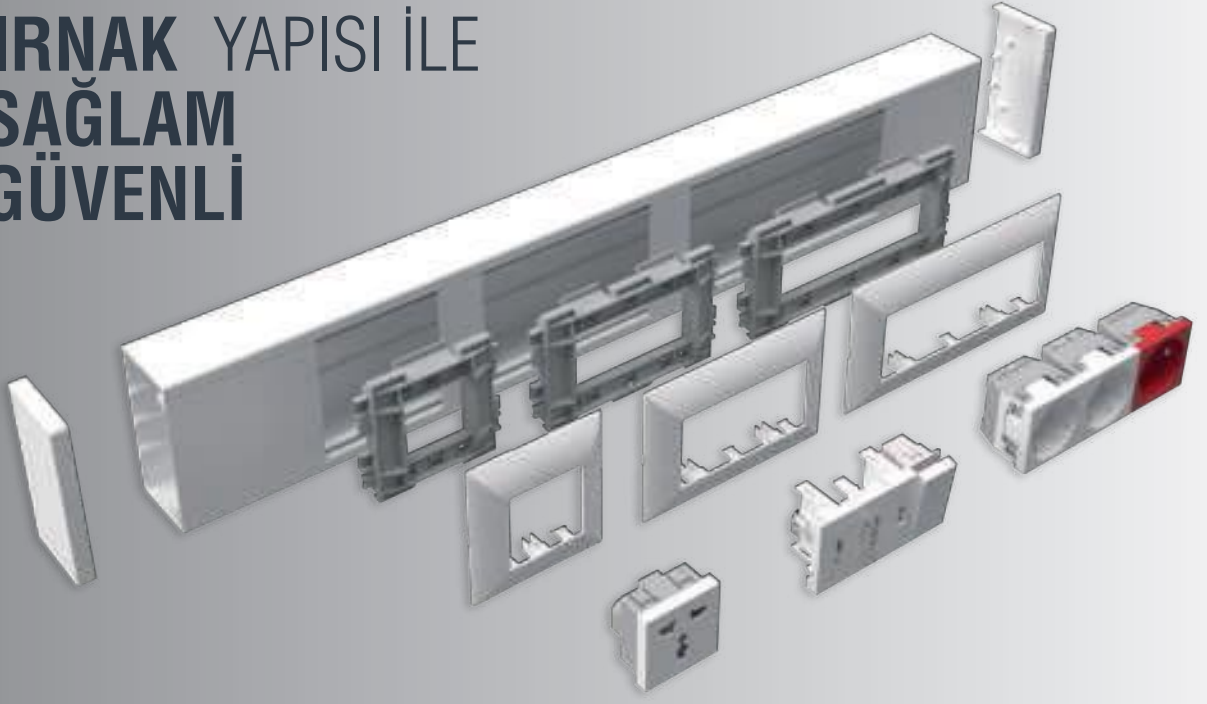

“Ofisinizde, evinizde düzensiz kablo karmaşasını düzenlemek için her zaman iyi bir seçimdir.”

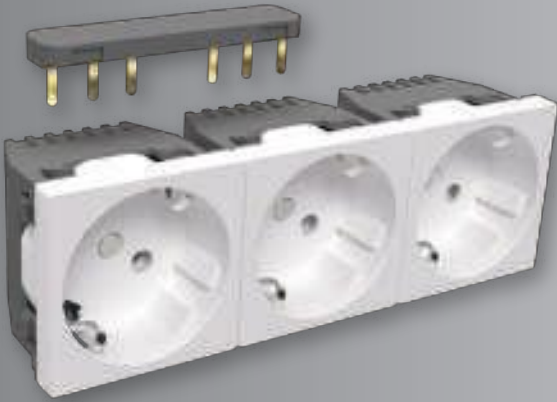

YENİ

LED  
İÇİN ÖZEL  
13x12,5mm



Kendinden Kapaklı  
Intrinsic Cover

Kendinden Yapışkanlı  
Self-Adhesive

Kendinden Yapışkanlı  
Self-Adhesive

Ürün Kodu	Ürün Adı	Amb. (Kutu)	Amb. Birimi	Fiyat (₺)
<b>LED İÇİN KENDİNDEN KAPAKLI KABLO KANALI</b>				
001 004 013012 20 44	13x12,5 MM KABLO KANALI ŞEFFAF KANAL (LED İÇİN)	300	mt.	39,63
<b>CANALEX SERİSİ TSE'Lİ KAPALI TİP KABLO KANALLARI (KUTULU)</b>				
001 156 012012 20 00	12x12 MM KABLO KANALI (CANALEX)	250	mt.	11,01
001 156 015010 20 00	15x10 MM KABLO KANALI (CANALEX)	250	mt.	11,65
001 156 016016 20 00	16x16 MM KABLO KANALI (CANALEX)	250	mt.	13,05
001 156 020010 20 00	20x10 MM KABLO KANALI (CANALEX)	200	mt.	13,55
001 156 020015 20 00	20x15 MM KABLO KANALI (CANALEX)	200	mt.	19,21
001 156 025016 20 00	25x16 MM KABLO KANALI (CANALEX)	150	mt.	20,07
001 156 025025 20 00	25x25 MM KABLO KANALI (CANALEX)	100	mt.	27,42
001 156 040016 20 00	40x16 MM KABLO KANALI (CANALEX)	100	mt.	33,00
001 156 040025 20 00	40x25 MM KABLO KANALI (CANALEX)	80	mt.	37,27
001 156 040040 20 00	40x40 MM KABLO KANALI (CANALEX)	50	mt.	47,68
001 156 060040 20 00	60x40 MM KABLO KANALI (CANALEX)	40	mt.	68,71
001 156 060060 20 00	60x60 MM KABLO KANALI (CANALEX)	32	mt.	104,00
001 156 080040 20 00	80x40 MM KABLO KANALI (CANALEX)	30	mt.	105,95
001 156 080060 20 00	80x60 MM KABLO KANALI (CANALEX)	24	mt.	125,20
001 156 100040 20 00	100x40 MM KABLO KANALI (CANALEX)	24	mt.	130,70
001 156 100060 20 00	100x60 MM KABLO KANALI (CANALEX)	20	mt.	183,13
<b>CANALEX SERİSİ KAPALI TİP KABLO KANALLARI (YAPIŞKAN BANTLI)</b>				
001 157 012012 20 00	12x12 MM KABLO KANALI CANALEX (YAPIŞKAN BANTLI)	250	mt.	13,19
001 157 015010 20 00	15x10 MM KABLO KANALI CANALEX (YAPIŞKAN BANTLI)	230	mt.	13,74
001 157 016016 20 00	16x16 MM KABLO KANALI CANALEX (YAPIŞKAN BANTLI)	240	mt.	16,08
001 157 020010 20 00	20x10 MM KABLO KANALI CANALEX (YAPIŞKAN BANTLI)	200	mt.	16,30
001 157 020015 20 00	20x15 MM KABLO KANALI CANALEX (YAPIŞKAN BANTLI)	180	mt.	23,55
001 157 025016 20 00	25x16 MM KABLO KANALI CANALEX (YAPIŞKAN BANTLI)	150	mt.	24,94
001 157 025025 20 00	25x25 MM KABLO KANALI CANALEX (YAPIŞKAN BANTLI)	100	mt.	32,69
001 157 040016 20 00	40x16 MM KABLO KANALI CANALEX (YAPIŞKAN BANTLI)	100	mt.	41,47
001 157 040025 20 00	40x25 MM KABLO KANALI CANALEX (YAPIŞKAN BANTLI)	80	mt.	46,38
001 157 040040 20 00	40x40 MM KABLO KANALI CANALEX (YAPIŞKAN BANTLI)	50	mt.	58,31
001 157 060040 20 00	60x40 MM KABLO KANALI CANALEX (YAPIŞKAN BANTLI)	40	mt.	81,00
<b>EKO SERİSİ TSE'Lİ KAPALI TİP KABLO KANALLARI</b>				
001 014 010008 20 00	10x08 MM KABLO KANALI EKO	330	mt.	11,64
001 014 012012 20 00	12x12 MM KABLO KANALI EKO	250	mt.	12,62
001 014 015010 20 00	15x10 MM KABLO KANALI EKO	250	mt.	12,84
001 014 015015 20 00	15x15 MM KABLO KANALI EKO	250	mt.	17,88
001 014 016016 20 00	16x16 MM KABLO KANALI EKO	250	mt.	19,58
001 014 020010 20 00	20x10 MM KABLO KANALI EKO	200	mt.	15,92
001 014 025016 20 00	25x16 MM KABLO KANALI EKO	150	mt.	25,20
001 014 025025 20 00	25x25 MM KABLO KANALI EKO	100	mt.	33,15
001 014 025040 20 00	25x40 MM KABLO KANALI EKO	80	mt.	62,95
001 014 930010 20 00	30x10 MM KABLO KANALI EKO (BÖLMELİ)	140	mt.	32,54
001 014 030015 20 00	30x15 MM KABLO KANALI EKO	140	mt.	28,78
001 014 930016 20 00	30x16 MM KABLO KANALI EKO (BÖLMELİ)	140	mt.	37,74
001 014 030016 20 00	30x16 MM KABLO KANALI EKO	140	mt.	33,57
001 014 030025 20 00	30x25 MM KABLO KANALI EKO	80	mt.	47,13
001 014 030030 20 00	30x30 MM KABLO KANALI EKO	80	mt.	44,50
001 014 940016 20 00	40x16 MM KABLO KANALI EKO (BÖLMELİ)	100	mt.	48,15
001 014 040016 20 00	40x16 MM KABLO KANALI EKO	100	mt.	37,35
001 014 040025 20 00	40x25 MM KABLO KANALI EKO	80	mt.	50,41
001 014 040040 20 00	40x40 MM KABLO KANALI EKO	50	mt.	56,02
001 014 040060 20 00	40x60 MM KABLO KANALI EKO	40	mt.	124,35
001 014 960025 20 00	60x25 MM KABLO KANALI EKO (BÖLMELİ)	40	mt.	83,93
001 014 060040 20 00	60x40 MM KABLO KANALI EKO	40	mt.	91,95
001 014 050050 20 00	50x50 MM KABLO KANALI EKO	30	mt.	107,05
001 014 060060 20 00	60x60 MM KABLO KANALI EKO	32	mt.	120,40
001 014 075075 20 00	75x75 MM KABLO KANALI EKO	28	mt.	178,90
001 014 080040 20 00	80x40 MM KABLO KANALI EKO	30	mt.	135,84
001 014 080060 20 00	80x60 MM KABLO KANALI EKO	24	mt.	150,75
001 014 100040 20 00	100x40 MM KABLO KANALI EKO (PRİZ SETİ TAKILABİLİR)	24	mt.	153,80
001 014 100037 20 00	100x37 MM KABLO KANALI İÇTEN KAPAKLI KANAL EKO FOLYOLU (PRİZ SETİ TAKILABİLİR)	30	mt.	170,88
001 014 100050 20 00	100x50 MM KABLO KANALI İÇTEN KAPAKLI KANAL EKO FOLYOLU (PRİZ SETİ TAKILABİLİR)	20	mt.	172,66
001 014 100060 20 00	100x60 MM KABLO KANALI EKO (PRİZ SETİ TAKILABİLİR)	20	mt.	198,34
001 014 120060 20 00	120x60 MM KABLO KANALI EKO	16	mt.	284,69
001 014 100100 20 00	100x100 MM KABLO KANALI EKO	20	mt.	340,20
<b>EKO SERİSİ KAPALI TİP KABLO KANALLARI (YAPIŞKAN BANTLI)</b>				
001 004 009005 20 00	9x5 MM KABLO KANALI KEN.KAPAKLI	500	mt.	17,85
001 004 010007 20 44	9,5x7 MM KABLO KANALI ŞEFFAF KANAL	500	mt.	25,64
001 004 012007 20 00	12x7,5 MM KABLO KANALI KENDİNDEN KAPAKLI	350	mt.	18,61
001 004 013012 20 00	13x12,5 MM KABLO KANALI KENDİNDEN KAPAKLI	300	mt.	23,21
001 004 010008 20 00	10x8 MM KABLO KANALI EKO (YAPIŞKAN BANTLI)	330	mt.	13,43
001 004 010010 20 00	10x10 MM KABLO KANALI EKO KENDİNDEN KAPAKLI (YAPIŞKAN BANTLI)	320	mt.	18,45
001 004 012012 20 00	12x12 MM KABLO KANALI EKO (YAPIŞKAN BANTLI)	250	mt.	14,85
001 004 015010 20 00	15x10 MM KABLO KANALI EKO (YAPIŞKAN BANTLI)	230	mt.	15,61
001 004 016016 20 00	16x16 MM KABLO KANALI EKO (YAPIŞKAN BANTLI)	240	mt.	21,25
001 004 020010 20 00	20x10 MM KABLO KANALI EKO (YAPIŞKAN BANTLI)	180	mt.	18,63
001 004 025016 20 00	25x16 MM KABLO KANALI EKO (YAPIŞKAN BANTLI)	150	mt.	30,17
001 004 025025 20 00	25x25 MM KABLO KANALI EKO (YAPIŞKAN BANTLI)	100	mt.	37,25
001 004 025040 20 00	25x40 MM KABLO KANALI EKO (YAPIŞKAN BANTLI)	80	mt.	67,72
001 004 930010 20 00	30x10 MM KABLO KANALI EKO (YAPIŞKAN BANTLI) (BÖLMELİ)	140	mt.	36,38
001 004 030016 20 00	30x16 MM KABLO KANALI EKO (YAPIŞKAN BANTLI)	140	mt.	37,70
001 004 030025 20 00	30x25 MM KABLO KANALI EKO (YAPIŞKAN BANTLI)	80	mt.	50,09
001 004 040016 20 00	40x16 MM KABLO KANALI EKO (YAPIŞKAN BANTLI)	100	mt.	43,28
001 004 040025 20 00	40x25 MM KABLO KANALI EKO (YAPIŞKAN BANTLI)	80	mt.	62,04
001 004 040040 20 00	40x40 MM KABLO KANALI EKO (YAPIŞKAN BANTLI)	50	mt.	66,82
001 004 060040 20 00	60x40 MM KABLO KANALI EKO (YAPIŞKAN BANTLI)	40	mt.	101,10

Ürün Kodu	Ürün Adı	Amb. (Kutu)	Amb. Birimi	Fiyat (₺)
<b>MEKS SERİSİ TSE'Lİ KAPALI TİP KABLO KANALLARI</b>				
001 002 015015 20 00	15x15 MM KABLO KANALI MEKS	250	mt.	21,58
001 002 016016 20 00	16x16 MM KABLO KANALI MEKS	250	mt.	24,24
001 002 025016 20 00	25x16 MM KABLO KANALI MEKS	150	mt.	32,57
001 002 025025 20 00	25x25 MM KABLO KANALI MEKS	100	mt.	43,52
001 002 030015 20 00	30x15 MM KABLO KANALI MEKS	140	mt.	40,33
001 002 030030 20 00	30x30 MM KABLO KANALI MEKS	80	mt.	54,63
001 002 040017 20 00	40x17 MM KABLO KANALI TAM KAPAKLI MEKS	100	mt.	57,02
001 002 940017 20 00	40x17 MM KABLO KANALI TAM KAPAKLI MEKS (BÖLMELİ)	100	mt.	62,72
001 002 040025 20 00	40x25 MM KABLO KANALI MEKS	80	mt.	60,36
001 002 040040 20 00	40x40 MM KABLO KANALI MEKS	50	mt.	70,58
001 002 960025 20 00	60x25 MM KABLO KANALI MEKS (BÖLMELİ)	40	mt.	93,67
001 002 060040 20 00	60x40 MM KABLO KANALI MEKS	40	mt.	95,04
001 002 080060 20 00	80x60 MM KABLO KANALI MEKS	24	mt.	158,25
001 002 100040 20 00	100x40 MM KABLO KANALI MEKS (PRİZ SETİ TAKILABİLİR)	24	mt.	199,75
001 002 100048 20 00	100x48 MM KABLO KANALI MEKS (PRİZ SETİ TAKILABİLİR)	24	mt.	256,75
001 002 100060 20 00	100x60 MM KABLO KANALI MEKS (PRİZ SETİ TAKILABİLİR)	20	mt.	257,22
001 002 120060 20 00	120x60 MM KABLO KANALI MEKS	16	mt.	313,94
<b>MEKS SERİSİ İÇTEN KAPAKLI KAPALI TİP KABLO KANALLARI</b>				
001 002 100037 20 00	100x37 MM KABLO KANALI MEKS (İÇTEN KAPAKLI)(FOLYOLU)	30	mt.	225,16
001 002 100041 20 00	100x41 MM KABLO KANALI MEKS (İÇTEN KAPAKLI)(FOLYOLU)	24	mt.	222,78
001 002 100050 20 00	100x50 MM KABLO KANALI MEKS (İÇTEN KAPAKLI)(FOLYOLU)	20	mt.	234,84
001 002 120070 20 00	120x70 MM KABLO KANALI (İÇTEN KAPAKLI)(AKSESUARLARI)	16	mt.	345,99
001 002 170070 20 00	170x70 MM KABLO KANALI (İÇTEN KAPAKLI)(AKSESUARLARI)	12	mt.	470,45
001 002 250070 20 00	250x70 MM KABLO KANALI (İÇTEN KAPAKLI)(AKSESUARLARI)	8	mt.	722,76
<b>MEKSPUS SERİSİ KAPALI TİP KABLO KANALLARI</b>				
001 003 100037 20 00	100x37 MM KABLO KANALI (İÇTEN KAPAKLI)	30	mt.	231,13
001 003 100041 20 00	100x41 MM KABLO KANALI (İÇTEN KAPAKLI)	24	mt.	234,98
001 003 100050 20 00	100x50 MM KABLO KANALI (İ. KAP.)(ET KALINLIĞI 2MM)	20	mt.	282,84
001 006 100050 20 00	100x50 MM KABLO KANALI (İÇTEN KAPAKLI)(KAİDESİZ SERİ)	20	mt.	295,73
001 003 120070 20 00	120x70 MM KABLO KANALI (İÇTEN KAPAKLI)(AKSESUARLARI)	16	mt.	403,24
001 003 170050 20 00	170x50 MM KABLO KANALI (İÇTEN KAPAKLI)	12	mt.	521,42
001 003 170070 20 00	170x70 MM KABLO KANALI (İÇTEN KAPAKLI)(AKSESUARLARI)	12	mt.	622,25
001 003 250070 20 00	250x70 MM KABLO KANALI (İÇTEN KAPAKLI)(AKSESUARLARI)	8	mt.	795,15
<b>MEKS SERİSİ KLİMA KANALI ve AKSESUARLARI</b>				
001 002 075060 20 00	75x60 MM KLİMA KANALI	30	mt.	150,56
001 050 030002 00 00	KLİMA KANALI KABLO TUTUCUSU	60	ad.	22,30
001 043 075060 00 00	KLİMA KANALI EK PARÇASI	40	ad.	26,63
001 039 075060 00 00	KLİMA KANALI İÇ KÖŞE	24	ad.	53,57
001 040 075060 00 00	KLİMA KANALI DIŞ KÖŞE	24	ad.	53,57
001 042 075060 00 00	KLİMA KANALI L KÖŞE	18	ad.	53,57
001 050 030001 00 00	KLİMA KANALI DUVAR GEÇİŞİ	60	ad.	31,84
001 044 075060 01 00	KLİMA KANALI İÇ SONLAMA	30	ad.	52,89
001 044 075060 02 00	KLİMA KANALI DIŞ SONLAMA	18	ad.	52,89
<b>TAVAN KÖŞE KANALI (23x23) ve AKSESUARLARI</b>				
001 002 023023 20 00	23x23 MM TAVAN KÖŞE KANALI	120	mt.	57,52
001 041 023023 00 00	23x23 MM T PARÇASI	60	ad.	16,43
001 042 023023 00 00	23x23 MM 90 L KÖŞE	60	ad.	16,43
001 043 023023 00 00	23x23 MM EK PARÇA	100	ad.	13,31
001 044 023023 00 00	23x23 MM UÇ TAPA	100	ad.	13,31
<b>SÜPÜRGELİK KABLO KANALLARI ve AKSESUARLARI</b>				
001 010 000200 20 00	50'LİK FUGALI SÜPÜRGELİK	60	mt.	54,49
001 014 974020 20 00	74x20 MM KABLO KANALI EKO (BÖLMELİ)	50	mt.	119,55
001 039 074020 00 00	74x20 İÇ KÖŞE	20	ad.	39,83
001 040 074020 00 00	74x20 DIŞ KÖŞE	20	ad.	39,83
001 041 074020 00 00	74x20 T KÖŞE	30	ad.	45,89
001 042 074020 01 00	74x20 90 L KÖŞE	40	ad.	45,89
001 043 074020 00 00	74x20 EK PARÇA	50	ad.	21,19
001 044 074020 00 00	74x20 UÇ TAPA	50	ad.	21,19
001 047 017420 00 00	74x20 PRİZ MONTAJ KASASI	6	ad.	118,45
001 047 017421 00 00	74x20 1' Lİ PRİZ MONTAJ KASASI	12	ad.	209,55
001 002 975022 20 00	75x22 MM KABLO KANALI (BÖLMELİ)	50	mt.	168,68
001 039 075022 00 00	75x22 MM İÇ KÖŞE	20	ad.	18,47
001 040 075022 00 00	75x22 MM DIŞ KÖŞE	20	ad.	18,47
001 044 075022 01 00	75x22 MM SAĞ SONLAMA	30	ad.	26,74
001 044 075022 02 00	75x22 MM SOL SONLAMA	20	ad.	26,74
001 043 075022 00 00	75x22 MM EK PARÇASI	100	ad.	25,13
<b>TEZGAH SÜPÜRGELİĞİ</b>				
001 011 000100 00 00	25'LİK TEZGAH SÜPÜRGELİĞİ 100CM	60	mt.	62,01
<b>BALIK SIRTI KANALLARI</b>				
001 002 050013 20 17	50x13 MM BALIK SIRTI KANAL (ZEMİN İÇİN)	60	mt.	67,22
001 002 060015 20 17	60x15 MM BALIK SIRTI KANAL (ZEMİN İÇİN)	40	mt.	77,33
001 002 075018 20 17	75x18 MM BALIK SIRTI KANAL (ZEMİN İÇİN)	30	mt.	131,09
001 002 090020 20 17	90x20 MM BALIK SIRTI KANAL (ZEMİN İÇİN)	20	mt.	169,88
001 004 050013 20 17	50x13 MM KABLO KANALI BALIK SIRTI (YAPIŞKAN BANTLI)	60	mt.	77,93
001 004 060015 20 17	60x15 MM KABLO KANALI BALIK SIRTI (YAPIŞKAN BANTLI)	40	mt.	86,23
001 004 075018 20 17	75x18 MM KABLO KANALI BALIK SIRTI (YAPIŞKAN BANTLI)	30	mt.	142,75
001 004 090020 20 17	90x20 MM KABLO KANALI BALIK SIRTI (YAPIŞKAN BANTLI)	20	mt.	187,63





Ürün Kodu	Ürün Adı	Amb. Birimi	Amb. Birimi	Fiyat (₺)
<b>H.FREE FLARET SERİSİ KAPALI TİP KABLO KANALLARI</b>				
001 060 100050 20 00	100x50 MM KABLO KANALI İÇTEN KAPAKLI HALOJEN FREE	20	mt.	694,98
001 061 100050 20 00	100x50 MM KABLO KANALI ARA BÖLME HALOJEN FREE	150	mt.	87,25
001 039 100050 11 00	100x50-37 MM KABLO KANALI İÇ KÖŞE(HAREKETLİ) HALOJEN FREE	12	ad.	76,05
001 040 100050 11 00	100x50 MM KABLO KANALI DIŞ KÖŞE(HAREKETLİ) HALOJEN FREE	10	ad.	76,05
001 041 100050 11 00	100x50 MM KABLO KANALI T PARÇASI HALOJEN FREE	10	ad.	88,50
001 042 100050 11 00	100x50 MM KABLO KANALI 90 L KÖŞE HALOJEN FREE	10	ad.	88,50
001 043 100050 11 00	100x50 MM KABLO KANALI EK PARÇA(ÜÇLÜ SET) HALOJEN FREE	100	ad.	26,31
001 044 100050 11 00	100x50 MM KABLO KANALI UÇ TAPA HALOJEN FREE	40	ad.	26,31
001 047 100001 11 00	PMS(100x37/50)(45X45)(1LÜ) HALOJEN FREE	30	ad.	58,56
001 047 100002 11 00	PMS(100x37/50)(45X45)(2LÜ) HALOJEN FREE	16	ad.	87,24
001 047 100003 11 00	PMS(100x37/50)(45X45)(3LÜ) HALOJEN FREE	14	ad.	123,01
<b>H.FREE FLARET SERİSİ KAPALI TİP KABLO KANALLARI</b>				
001 060 025016 20 00	25x16 MM KABLO KANALI HALOJEN FREE	150	mt.	129,32
001 060 025025 20 00	25x25 MM KABLO KANALI HALOJEN FREE	100	mt.	140,58
001 060 040025 20 00	40x25 MM KABLO KANALI HALOJEN FREE	80	mt.	205,72
001 060 040040 20 00	40x40 MM KABLO KANALI HALOJEN FREE	50	mt.	239,22
<b>25x16 H.FREE FLARET KANAL AKSESUARLARI</b>				
001 039 025016 11 00	25x16 MM İÇ KÖŞE	40	ad.	18,04
001 040 025016 11 00	25x16 MM DIŞ KÖŞE	40	ad.	18,04
001 041 025016 11 00	25x16 MM T PARÇASI	30	ad.	24,61
001 042 025016 11 00	25x16 MM 90 L KÖŞE	80	ad.	24,61
001 043 025016 11 00	25x16 MM EK PARÇA	100	ad.	16,04
001 044 025016 11 00	25x16 MM UÇ TAPA	100	ad.	16,04
<b>25x25 H.FREE FLARET KANAL AKSESUARLARI</b>				
001 039 025025 11 00	25x25 MM İÇ KÖŞE	40	ad.	18,32
001 040 025025 11 00	25x25 MM DIŞ KÖŞE	40	ad.	18,32
001 041 025025 11 00	25x25 MM T PARÇASI	30	ad.	29,04
001 042 025025 11 00	25x25 MM 90 L KÖŞE	50	ad.	29,04
001 043 025025 11 00	25x25 MM EK PARÇA	100	ad.	16,93
001 044 025025 11 00	25x25 MM UÇ TAPA	100	ad.	16,93
<b>40x25 H.FREE FLARET KANAL AKSESUARLARI</b>				
001 039 040025 11 00	40x25 MM İÇ KÖŞE	24	ad.	53,00
001 040 040025 11 00	40x25 MM DIŞ KÖŞE	30	ad.	53,00
001 041 040025 11 00	40x25 MM T PARÇASI	18	ad.	65,68
001 042 040025 11 00	40x25 MM 90 L KÖŞE	24	ad.	65,68
001 043 040025 11 00	40x25 MM EK PARÇA	70	ad.	40,11
001 044 040025 11 00	40x25 MM UÇ TAPA	25	ad.	40,11
<b>40x40 H.FREE FLARET KANAL AKSESUARLARI</b>				
001 039 040040 11 00	40x40 MM İÇ KÖŞE	18	ad.	58,18
001 040 040040 11 00	40x40 MM DIŞ KÖŞE	16	ad.	58,18
001 041 040040 11 00	40x40 MM T PARÇASI	48	ad.	60,12
001 042 040040 11 00	40x40 MM 90 L KÖŞE	60	ad.	60,12
001 043 040040 11 00	40x40 MM EK PARÇA	100	ad.	39,50
001 044 040040 11 00	40x40 MM UÇ TAPA	25	ad.	39,50



Ürün Kodu	Ürün Adı	Amb. (Kutu)	Amb. Birimi	Fiyat (₺)
<b>BALIK SIRTI 60x15 AKSESUARLARI</b>				
001 042 060015 00 17	60x15 MM BALIK SIRTI KANAL L KÖŞE	24	ad.	27,04
001 043 060015 00 17	60x15 MM BALIK SIRTI KANAL EK PARÇASI	50	ad.	16,45
001 044 060015 00 17	60x15 MM BALIK SIRTI KANAL SONLAMA KAPAĞI	50	ad.	15,46
001 041 060015 00 17	60x15 MM BALIK SIRTI KANAL T KÖŞE	10	ad.	43,04
<b>BALIK SIRTI 75x18 AKSESUARLARI</b>				
001 042 075018 00 17	75x18 MM BALIK SIRTI KANAL L KÖŞE	15	ad.	46,53
001 043 075018 00 17	75x18 MM BALIK SIRTI KANAL EK PARÇASI	50	ad.	21,21
001 044 075018 00 17	75x18 MM BALIK SIRTI KANAL SONLAMA KAPAĞI	50	ad.	11,65
001 041 075018 00 17	75x18 MM BALIK SIRTI KANAL T KÖŞE	8	ad.	47,86
<b>BALIK SIRTI 90x20 AKSESUARLARI</b>				
001 042 090020 00 17	90x20 MM BALIK SIRTI KANAL KANAL L KÖŞE	20	ad.	50,86
001 043 090020 00 17	90x20 MM BALIK SIRTI KANAL EK PARÇASI	50	ad.	13,10
001 044 090020 00 17	90x20 MM BALIK SIRTI KANAL SONLAMA KAPAĞI	50	ad.	18,26
001 041 090020 00 17	90x20 MM BALIK SIRTI KANAL T KÖŞE	12	ad.	44,07
<b>12X12 KANAL AKSESUARLARI</b>				
001 039 012012 00 00	12x12 MM İÇ KÖŞE	60	ad.	10,36
001 040 012012 00 00	12x12 MM DIŞ KÖŞE	60	ad.	10,36
001 041 012012 00 00	12x12 MM T KÖŞE	60	ad.	10,71
001 042 012012 00 00	12x12 MM 90 L KÖŞE	60	ad.	10,71
001 044 012012 00 00	12x12 MM UÇ TAPA	100	ad.	10,00
001 043 012012 00 00	12x12 MM EK PARÇASI	100	ad.	10,00
<b>15X10 KANAL AKSESUARLARI</b>				
001 039 015010 00 00	15x10 MM İÇ KÖŞE	60	ad.	10,54
001 040 015010 00 00	15x10 MM DIŞ KÖŞE	60	ad.	10,54
001 041 015010 00 00	15x10 MM T KÖŞE	60	ad.	11,07
001 042 015010 00 00	15x10 MM 90 L KÖŞE	60	ad.	11,07
001 044 015010 00 00	15x10 MM UÇ TAPA	100	ad.	10,36
001 043 015010 00 00	15x10 MM EK PARÇASI	100	ad.	10,36
<b>20X10 KANAL AKSESUARLARI</b>				
001 039 020010 00 00	20x10 MM İÇ KÖŞE	60	ad.	10,71
001 040 020010 00 00	20x10 MM DIŞ KÖŞE	60	ad.	10,71
001 041 020010 00 00	20x10 MM T KÖŞE	30	ad.	14,54
001 042 020010 00 00	20x10 MM 90 L KÖŞE	50	ad.	14,54
001 044 020010 00 00	20x10 MM UÇ TAPA	100	ad.	9,57
001 043 020010 00 00	20x10 MM EK PARÇASI	100	ad.	9,57
<b>16X16 KANAL AKSESUARLARI</b>				
001 039 016016 00 00	16x16 MM İÇ KÖŞE	100	ad.	14,20
001 040 016016 00 00	16x16 MM DIŞ KÖŞE	100	ad.	14,20
001 041 016016 00 00	16x16 MM T KÖŞE	60	ad.	15,36
001 042 016016 00 00	16x16 MM 90 L KÖŞE	60	ad.	15,36
001 044 016016 00 00	16x16 MM UÇ TAPA	100	ad.	10,71
001 043 016016 00 00	16x16 MM EK PARÇASI	100	ad.	10,71
<b>25X16 KANAL AKSESUARLARI</b>				
001 039 025016 00 00	25x16 MM İÇ KÖŞE	40	ad.	13,39
001 040 025016 00 00	25x16 MM DIŞ KÖŞE	40	ad.	13,39
001 041 025016 00 00	25x16 MM T KÖŞE	30	ad.	21,31
001 042 025016 00 00	25x16 MM 90 L KÖŞE	80	ad.	21,31
001 044 025016 00 00	25x16 MM UÇ TAPA	100	ad.	12,86
001 043 025016 00 00	25x16 MM EK PARÇASI	100	ad.	12,86
001 047 017421 00 00	25x16 MM PMK (45x45)	12	ad.	209,55
<b>25X25 KANAL AKSESUARLARI</b>				
001 039 025025 00 00	25x25 MM İÇ KÖŞE	40	ad.	15,46
001 040 025025 00 00	25x25 MM DIŞ KÖŞE	40	ad.	15,46
001 041 025025 00 00	25x25 MM T KÖŞE	24	ad.	24,99
001 042 025025 00 00	25x25 MM 90 L KÖŞE	40	ad.	24,99
001 044 025025 00 00	25x25 MM UÇ TAPA	100	ad.	14,75
001 043 025025 00 00	25x25 MM EK PARÇASI	50	ad.	14,75
001 047 017421 00 00	25x25 MM PMK (45x45)	12	ad.	209,55
<b>30X10 KANAL AKSESUARLARI</b>				
001 039 030010 00 00	30x10 MM İÇ KÖŞE	50	ad.	21,73
001 040 030010 00 00	30x10 MM DIŞ KÖŞE	50	ad.	21,73
001 041 030010 00 00	30x10 MM T KÖŞE	50	ad.	29,18
001 042 030010 00 00	30x10 MM 90 L KÖŞE	50	ad.	29,18
001 044 030025 00 00	30x10-16-25 MM UÇ TAPA	100	ad.	13,08
001 043 030025 00 00	30x10-16-25 MM EK PARÇASI	100	ad.	13,08
<b>30X16 KANAL AKSESUARLARI</b>				
001 039 030016 00 00	30x16 MM İÇ KÖŞE	35	ad.	39,09
001 040 030016 00 00	30x16 MM DIŞ KÖŞE	48	ad.	39,09
001 041 030016 00 00	30x16 MM T KÖŞE	40	ad.	40,53
001 042 030016 00 00	30x16 MM 90 L KÖŞE	50	ad.	40,53
001 044 030025 00 00	30x10-16-25 MM UÇ TAPA	100	ad.	20,48
001 043 030025 00 00	30x10-16-25 MM EK PARÇASI	100	ad.	20,48
<b>30X25 KANAL AKSESUARLARI</b>				
001 039 030025 00 00	30x25 MM İÇ KÖŞE	30	ad.	34,52
001 040 030025 00 00	30x25 MM DIŞ KÖŞE	32	ad.	34,52
001 041 030025 00 00	30x25 MM T KÖŞE	24	ad.	35,93
001 042 030025 00 00	30x25 MM 90 L KÖŞE	30	ad.	35,93
001 044 030025 00 00	30x10-16-25 MM UÇ TAPA	100	ad.	20,48
001 043 030025 00 00	30x10-16-25 MM EK PARÇASI	100	ad.	20,48



EK PARÇA



T KÖŞE



İÇ KÖŞE



DIŞ KÖŞE



L KÖŞE



UÇ TAPA





UÇ TAPA



T KÖŞE

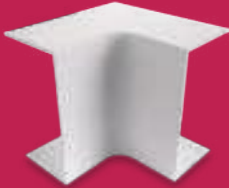

İÇ KÖŞE



EK PARÇA

PRİZ MONTAJ KASASI

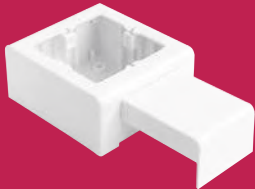

Ürün Kodu	Ürün Adı	Amb. (Kutu)	Amb. Birimi	Fiyat (₺)
<b>40X16 KANAL AKSESUARLARI</b>				
⚡ CE IP40				
001 039 040016 00 00	40x16 MM İÇ KÖŞE	32	ad.	28,57
001 040 040016 00 00	40x16 MM DİŞ KÖŞE	30	ad.	28,57
001 041 040016 00 00	40x16 MM T KÖŞE	24	ad.	32,14
001 042 040016 00 00	40x16 MM 90 L KÖŞE	34	ad.	32,14
001 044 040040 00 00	40x16-25-40 MM UÇ TAPA	25	ad.	25,00
001 043 040016 00 00	40x16-25-40 MM EK PARÇASI	100	ad.	25,00
001 047 017421 00 00	40x165 MM PMK (45x45)	12	ad.	209,55
<b>40X25 KANAL AKSESUARLARI</b>				
⚡ CE IP40				
001 039 040025 00 00	40x25 MM İÇ KÖŞE	24	ad.	29,46
001 040 040025 00 00	40x25 MM DİŞ KÖŞE	30	ad.	29,46
001 041 040025 00 00	40x25 MM T KÖŞE	18	ad.	33,04
001 042 040025 00 00	40x25 MM 90 L KÖŞE	24	ad.	33,04
001 044 040040 00 00	40x16-25-40 MM UÇ TAPA	25	ad.	25,00
001 043 040016 00 00	40x16-25-40 MM EK PARÇASI	100	ad.	25,00
001 047 017421 00 00	40x25 MM PMK (45x45)	12	ad.	209,55
<b>40X40 KANAL AKSESUARLARI</b>				
⚡ CE IP40				
001 039 040040 01 00	40x40 MM İÇ KÖŞE (HAREKETLİ)	18	ad.	30,36
001 040 040040 01 00	40x40 MM DİŞ KÖŞE (HAREKETLİ)	16	ad.	30,36
001 041 040040 00 00	40x40 MM T KÖŞE	48	ad.	33,93
001 042 040040 00 00	40x40 MM 90 L KÖŞE	60	ad.	33,93
001 044 040040 00 00	40x16-25-40 MM UÇ TAPA	50	ad.	25,00
001 043 040016 00 00	40x16-25-40 MM EK PARÇASI	100	ad.	25,00
001 047 017421 00 00	40x40 MM PMK (45x45)	12	ad.	209,55
<b>60X25 KANAL AKSESUARLARI</b>				
⚡ CE IP40				
001 039 060025 00 00	60x25 MM İÇ KÖŞE	48	ad.	32,98
001 040 060025 00 00	60x25 MM DİŞ KÖŞE	72	ad.	32,98
001 041 060025 00 00	60x25 MM T KÖŞE	40	ad.	39,62
001 042 060025 00 00	60x25 MM 90 L KÖŞE	60	ad.	39,62
001 044 060025 00 00	60x25 MM UÇ TAPA	50	ad.	23,19
001 043 060025 00 00	60x25 MM EK PARÇASI	60	ad.	23,19
<b>60X40 KANAL AKSESUARLARI</b>				
⚡ CE IP40				
001 039 060040 00 00	60x40 MM İÇ KÖŞE	26	ad.	41,62
001 040 060040 00 00	60x40 MM DİŞ KÖŞE	32	ad.	41,62
001 041 060040 00 00	60x40 MM T KÖŞE	32	ad.	42,71
001 042 060040 00 00	60x40 MM 90 L KÖŞE	40	ad.	42,71
001 044 060040 00 00	60x40 MM UÇ TAPA	50	ad.	23,32
001 043 060040 00 00	60x40 MM EK PARÇASI	40	ad.	23,32
<b>60X60 KANAL AKSESUARLARI</b>				
⚡ CE IP40				
001 039 060060 01 00	60x60 MM İÇ KÖŞE (HAREKETLİ)	16	ad.	58,16
001 040 060060 01 00	60x60 MM DİŞ KÖŞE (HAREKETLİ)	16	ad.	58,16
001 041 060060 00 00	60x60 MM T KÖŞE	20	ad.	74,37
001 042 060060 00 00	60x60 MM 90 L KÖŞE	24	ad.	74,37
001 044 060060 00 00	60x60 MM UÇ TAPA	30	ad.	38,65
001 043 060060 00 00	60x60 MM EK PARÇASI	25	ad.	38,65
<b>80X40 KANAL AKSESUARLARI</b>				
⚡ CE IP40				
001 039 080040 00 00	80x40 MM İÇ KÖŞE	18	ad.	68,78
001 040 080040 00 00	80x40 MM DİŞ KÖŞE	8	ad.	68,78
001 041 080040 00 00	80x40 MM T KÖŞE	12	ad.	74,81
001 042 080040 00 00	80x40 MM 90 L KÖŞE	16	ad.	74,81
001 044 080040 00 00	80x40 MM UÇ TAPA	60	ad.	55,36
001 043 080040 00 00	80x40 MM EK PARÇASI	100	ad.	55,36
<b>80X60 KANAL AKSESUARLARI</b>				
⚡ CE IP40				
001 039 080060 00 00	80x60 MM İÇ KÖŞE	12	ad.	73,42
001 040 080060 00 00	80x60 MM DİŞ KÖŞE	8	ad.	73,42
001 041 080060 00 00	80x60 MM T KÖŞE	10	ad.	82,43
001 042 080060 00 00	80x60 MM 90 L KÖŞE	12	ad.	82,43
001 044 080060 00 00	80x60 MM UÇ TAPA	48	ad.	57,67
001 043 080060 00 00	80x60 MM EK PARÇASI	80	ad.	57,67
<b>100X37 KANAL AKSESUARLARI</b>				
⚡ CE IP40				
001 039 100037 00 00	100x37 MM İÇ KÖŞE (SABİT)	12	ad.	56,75
001 040 100037 00 00	100x37 MM DİŞ KÖŞE (SABİT)	8	ad.	56,75
001 039 100037 01 00	100x37 MM İÇ KÖŞE (HAREKETLİ)	12	ad.	56,75
001 040 100037 01 00	100x37 MM DİŞ KÖŞE (HAREKETLİ)	10	ad.	56,75
001 041 100037 00 00	100x37 MM T PARÇASI	14	ad.	62,17
001 042 100037 00 00	100x37 MM 90 L KÖŞE	14	ad.	62,17
001 044 100037 00 00	100x37 MM UÇ TAPA	50	ad.	30,55
001 043 100037 00 00	100x37 MM EK PARÇA	100	ad.	30,55
<b>100X40 KANAL AKSESUARLARI</b>				
⚡ CE IP40				
001 039 100040 00 00	100x40 MM İÇ KÖŞE (SABİT)	8	ad.	69,77
001 040 100040 00 00	100x40 MM DİŞ KÖŞE (SABİT)	8	ad.	69,77
001 039 100040 01 00	100x40 MM İÇ KÖŞE (HAREKETLİ)	16	ad.	69,77
001 040 100040 01 00	100x40 MM DİŞ KÖŞE (HAREKETLİ)	10	ad.	69,77
001 041 100040 00 00	100x40 MM T PARÇASI	12	ad.	87,62
001 042 100040 00 00	100x40 MM 90 L KÖŞE	12	ad.	87,62
001 044 100040 00 00	100x40 MM UÇ TAPA	20	ad.	31,96
001 043 100040 00 00	100x40 MM EK PARÇA	100	ad.	31,96
001 050 030004 00 00	100x40 MM KANAL KİLİTLEME APARATI	100	ad.	11,57
001 013 100040 20 00	100x40 MM ARA BÖLME	200	mt.	40,95

Ürün Kodu	Ürün Adı	Amb. (Kutu)	Amb. Birimi	Fiyat (₺)
<b>100X48 KANAL AKSESUARLARI</b>				
⚡ CE IP40				
001 039 100048 00 00	100X48 MM İÇ KÖŞE (SABİT)	8	ad.	71,58
001 040 100048 00 00	100X48 MM DIŞ KÖŞE (SABİT)	8	ad.	71,58
001 039 100048 01 00	100X48 MM İÇ KÖŞE (HAREKETLİ)	10	ad.	71,58
001 040 100048 01 00	100X48 MM DIŞ KÖŞE (HAREKETLİ)	10	ad.	71,58
001 041 100048 00 00	100X48 MM T PARÇASI	8	ad.	89,75
001 042 100048 00 00	100X48 MM 90 L KÖŞE	8	ad.	89,75
001 044 100048 00 00	100X48 MM UÇ TAPA	20	ad.	36,22
001 043 100048 00 00	100X48 MM EK PARÇA	100	ad.	36,22
001 050 030004 00 00	100X48 MM KANAL KİLİTLEME APARATI	100	ad.	11,57
001 013 100048 20 00	100X48 MM ARA BÖLME	150	mt.	33,80
<b>100X50/41 KANAL AKSESUARLARI</b>				
⚡ CE IP40				
001 039 100050 00 00	100X50/41 MM İÇ KÖŞE (SABİT)	8	ad.	45,06
001 040 100050 00 00	100X50/41 MM DIŞ KÖŞE (SABİT)	8	ad.	45,06
001 039 100050 01 00	100X50/41 MM İÇ KÖŞE (HAREKETLİ)	10	ad.	45,06
001 040 100050 01 00	100X50/41 MM DIŞ KÖŞE (HAREKETLİ)	8	ad.	45,06
001 041 100050 00 00	100X50/41 MM T PARÇASI	10	ad.	58,58
001 042 100050 00 00	100X50/41 MM 90 L KÖŞE	10	ad.	58,58
001 044 100050 00 00	100X50/41 MM UÇ TAPA	40	ad.	31,13
001 043 100050 00 00	100X50/41 MM EK PARÇA	100	ad.	31,13
001 043 100050 01 00	100X50 MM EK PARÇA (3LÜ SET)	100	ad.	31,13
001 046 195100 00 00	100X50 MM KANAL İÇİ KÜP BUAZ	25	ad.	46,38
001 013 100048 20 00	100X48 - 100X50 MM ARA BÖLME	150	mt.	33,80
<b>100X50 KAİDESİZ KANAL AKSESUARLARI</b>				
⚡ CE IP40				
001 039 100051 00 00	100X50 MM KAİDESİZ İÇ KÖŞE	8	ad.	53,28
001 040 100051 00 00	100X50 MM KAİDESİZ DIŞ KÖŞE	8	ad.	53,28
001 041 100051 00 00	100X50 MM KAİDESİZ T PARÇASI	10	ad.	76,51
001 042 100051 00 00	100X50 MM KAİDESİZ 90 L KÖŞE	10	ad.	76,51
001 043 100051 00 00	100X50 MM KAİDESİZ EK PARÇA	100	ad.	41,37
001 044 100051 00 00	100X50 MM KAİDESİZ UÇ TAPA	40	ad.	41,37
001 888 100050 00 00	100X50 MM KABLO KANALI MONTAJ APARATI	50	ad.	43,55
<b>100X60 KANAL AKSESUARLARI</b>				
⚡ CE IP40				
001 039 100060 00 00	100X60 MM İÇ KÖŞE (SABİT)	8	ad.	77,22
001 040 100060 00 00	100X60 MM DIŞ KÖŞE (SABİT)	8	ad.	77,22
001 039 100060 01 00	100X60 MM İÇ KÖŞE (HAREKETLİ)	8	ad.	77,22
001 040 100060 01 00	100X60 MM DIŞ KÖŞE (HAREKETLİ)	10	ad.	77,22
001 041 100060 00 00	100X60 MM T PARÇASI	8	ad.	88,71
001 042 100060 00 00	100X60 MM 90 L KÖŞE	8	ad.	88,71
001 044 100060 00 00	100X60 MM UÇ TAPA	16	ad.	23,49
001 043 100060 00 00	100X60 MM EK PARÇA	100	ad.	23,49
001 050 030004 00 00	100X60 MM KANAL KİLİTLEME APARATI	100	ad.	11,57
001 013 100060 20 00	100X60 MM ARA BÖLME	130	ad.	50,56
<b>120X60 KANAL AKSESUARLARI</b>				
⚡ CE IP40				
001 039 120060 00 00	120X60 MM İÇ KÖŞE	8	ad.	90,25
001 040 120060 00 00	120X60 MM DIŞ KÖŞE	8	ad.	90,25
001 041 120060 00 00	120X60 MM T PARÇA	8	ad.	94,56
001 042 120060 00 00	120X60 MM 90 L KÖŞE	8	ad.	94,56
001 044 120060 00 00	120X60 MM UÇ TAPA	20	ad.	29,71
001 043 120060 00 00	120X60 MM EK PARÇA	50	ad.	29,71
<b>170X50 KANAL AKSESUARLARI</b>				
⚡ CE IP40				
001 039 170050 00 00	170X50 MM İÇ KÖŞE	32	ad.	111,57
001 040 170050 00 00	170X50 MM DIŞ KÖŞE	44	ad.	111,57
001 041 170050 00 00	170X50 MM T PARÇA	16	ad.	133,86
001 042 170050 00 00	170X50 MM 90 L KÖŞE	16	ad.	133,86
001 044 170050 00 00	170X50 MM UÇ TAPA	125	ad.	36,35
001 043 170050 00 00	170X50 MM EK PARÇA	125	ad.	36,35
<b>İÇTEN KAPAKLI 100X37/50 İÇİN PRİZ MONTAJ SETİ (45x45)</b>				
⚡ CE IP40				
001 047 070001 00 00	100X37/50 İÇİN 45X45 PMS (TEKLİ)	30	ad.	35,04
001 047 070002 00 00	100X37/50 İÇİN 45X45 PMS (İKİLİ)	16	ad.	46,89
001 047 070003 00 00	100X37/50 İÇİN 45X45 PMS (ÜÇLÜ)	14	ad.	53,54
001 047 070004 00 00	100X37/50 İÇİN 45X45 PMS (DÖRTLÜ)	13	ad.	94,04
<b>İÇTEN KAPAKLI 100X37/50 İÇİN PRİZ MONTAJ SETİ (55X55)</b>				
001 047 080001 00 00	100X37/50 İÇİN 55X55 PMS (TEKLİ)	20	ad.	54,11
001 047 080002 00 00	100X37/50 İÇİN 55X55 PMS (İKİLİ)	14	ad.	89,91
001 047 080003 00 00	100X37/50 İÇİN 55X55 PMS (ÜÇLÜ)	12	ad.	107,86
<b>DIŞTAN KAPAKLI 100'LÜK KANAL PRİZ MONTAJ SETİ (55X55)</b>				
001 047 020001 00 00	100'LÜK 55X55 PMS TEKLİ	20	ad.	87,79
001 047 020002 00 00	100'LÜK 55X55 PMS İKİLİ	14	ad.	109,94
001 047 020003 00 00	100'LÜK 55X55 PMS ÜÇLÜ	12	ad.	136,22
<b>DIŞTAN KAPAKLI 100'LÜK KANAL PRİZ MONTAJ SETİ (45x45)</b>				
⚡ CE IP40				
001 047 040001 00 00	100'LÜK 45X45 PMS TEKLİ	20	ad.	69,72
001 047 040002 00 00	100'LÜK 45X45 PMS İKİLİ	14	ad.	100,49
001 047 040003 00 00	100'LÜK 45X45 PMS ÜÇLÜ	12	ad.	140,40
001 047 040004 00 00	100'LÜK 45X45 PMS DÖRTLÜ	10	ad.	150,43
<b>İNGİLİZ NORMU PRİZ MONTAJ SETLERİ (100x50/37)</b>				
001 047 980001 00 00	İNGİLİZ NORMU TEKLİ PRİZ TABANI	200	ad.	35,57
001 047 980002 00 00	İNGİLİZ NORMU İKİLİ PRİZ TABANI	100	ad.	38,06
001 047 990002 00 00	İNGİLİZ NORMU İKİLİ YÜKSEK TİP PRİZ TABANI	94	ad.	71,94
001 166 000001 00 00	SIVA ALTI ANAHTAR KASASI	28	ad.	36,32





## KANAL İÇİN UPS VE ENERJİ PRİZLERİ (45x45)



ÜRÜN KODU	001 052 300001 00 00
ÜRÜN ADI	45x45 TOP.P. ÇEKİRDEĞİ Ç.K. (45°)
AMB. AD./KOLİ	50/300
FİYAT (₺)	72,89



ÜRÜN KODU	001 052 300002 00 00
ÜRÜN ADI	45x45 UPS.P. ÇEKİRDEĞİ Ç.K. (45°)
AMB. AD./KOLİ	50/300
FİYAT (₺)	73,92



ÜRÜN KODU	001 052 200003 00 00
ÜRÜN ADI	45x45 PRİZ BİRLEŞTİRME APARATI (YANDAN) (YENİ)
AMB. AD./KOLİ	500/5000
FİYAT (₺)	27,59



ÜRÜN KODU	001 052 200005 00 00
ÜRÜN ADI	45x45 PRİZ BİRLEŞTİRME APARATI
AMB. AD./KOLİ	500/5000
FİYAT (₺)	44,75



ÜRÜN KODU	888 049 050040
ÜRÜN ADI	45x22,5 ANAHTAR
AMB. AD./KOLİ	20/400
FİYAT	3,36 \$



ÜRÜN KODU	888 049 050043
ÜRÜN ADI	45x22,5 VAVİEN
AMB. AD./KOLİ	20/400
FİYAT	3,90 \$



ÜRÜN KODU	888 049 050063
ÜRÜN ADI	45x45 ANAHTAR
AMB. AD./KOLİ	10/200
FİYAT	4,81 \$



ÜRÜN KODU	888 049 050044
ÜRÜN ADI	45x45 YAYLI ÇAĞIRMA (LIGHT)
AMB. AD./KOLİ	10/200
FİYAT	4,81 \$



ÜRÜN KODU	888 049 050064
ÜRÜN ADI	45x45 ARA VAVİEN
AMB. AD./KOLİ	10/200
FİYAT	6,60 \$



ÜRÜN KODU	888 049 050065
ÜRÜN ADI	45x45 VAVİEN
AMB. AD./KOLİ	10/200
FİYAT	5,10 \$

## KANAL İÇİN UPS VE ENERJİ PRİZLERİ (45x45)



ÜRÜN KODU	888 049 050042
ÜRÜN ADI	45x45 KOMITATÖR
AMB. AD./KOLİ	10/200
FİYAT	5,90 \$



ÜRÜN KODU	888 049 050041
ÜRÜN ADI	45x45 ÇOK AMAÇLI PRİZ
AMB. AD./KOLİ	10/200
FİYAT	5,90 \$



ÜRÜN KODU	888 049 050058
ÜRÜN ADI	45x22,5 USB 2.0 - AF/AF DATA 90 GİRİŞ
AMB. AD./KOLİ	50/500
FİYAT	3,08 \$



ÜRÜN KODU	888 049 050059
ÜRÜN ADI	45x22,5 USB 2.0 - AF/AF DATA 180 GİRİŞ
AMB. AD./KOLİ	50/500
FİYAT	3,08 \$



ÜRÜN KODU	888 049 050046
ÜRÜN ADI	45x22,5 HDMI 90 GİRİŞ
AMB. AD./KOLİ	50/500
FİYAT	8,76 \$

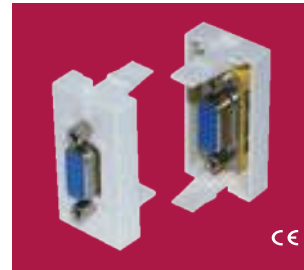

ÜRÜN KODU	888 049 050047
ÜRÜN ADI	45x22,5 VGA DATA JACK
AMB. AD./KOLİ	50/500
FİYAT	4,98 \$



ÜRÜN KODU	888 049 050056
ÜRÜN ADI	45x22,5 TV PRİZİ ERKEK
AMB. AD./KOLİ	50/500
FİYAT	2,23 \$

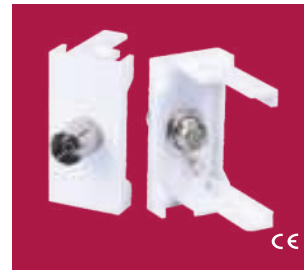

ÜRÜN KODU	888 049 050057
ÜRÜN ADI	45x22,5 TV PRİZİ DIŞI
AMB. AD./KOLİ	50/500
FİYAT	2,33 \$



ÜRÜN KODU	888 049 050049
ÜRÜN ADI	45x22,5 RCA
AMB. AD./KOLİ	50/500
FİYAT	5,49 \$



ÜRÜN KODU	888 049 050060
ÜRÜN ADI	45x22,5 SES JAKI 3,5 mm STEREO
AMB. AD./KOLİ	50/500
FİYAT	3,02 \$



## KANAL İÇİN UPS VE ENERJİ PRİZLERİ (45x45)



ÜRÜN KODU	888 049 050051
ÜRÜN ADI	45x22,5 KÖR KAPAK
AMB. AD./KOLİ	100/1000
FİYAT	0,35 \$



ÜRÜN KODU	888 049 050012
ÜRÜN ADI	45x22,5 KEYSTONE JACK PANJURLU KAPAK
AMB. AD./KOLİ	100/1000
FİYAT	0,47 \$



ÜRÜN KODU	888 049 050055
ÜRÜN ADI	45x45 KÖR KAPAK
AMB. AD./KOLİ	100/400
FİYAT	0,36 \$



ÜRÜN KODU	888 049 050013
ÜRÜN ADI	45x45 KEYSTONE JACK PANJURLU KAPAK
AMB. AD./KOLİ	100/500
FİYAT	0,65 \$



ÜRÜN KODU	888 049 050061
ÜRÜN ADI	45x22,5 USB ŞARJ PRİZİ 5V 2,1A
AMB. AD./KOLİ	10/200
FİYAT	22,04 \$



ÜRÜN KODU	888 049 050062
ÜRÜN ADI	45x22,5 U2'Lİ USB ŞARJ PRİZİ 5V 2,1A
AMB. AD./KOLİ	20/200
FİYAT	24,89 \$



ÜRÜN KODU	888 049 050074
ÜRÜN ADI	45x45 ŞARJ PRİZİ TYPE-C+ TYPE-C (C+C) 5V 4.2A
AMB. AD./KOLİ	10/200
FİYAT	28,30 \$



ÜRÜN KODU	888 049 050075
ÜRÜN ADI	45x45 ŞARJ PRİZİ TYPE-C (C) 5V 3A
AMB. AD./KOLİ	10/200
FİYAT	21,43 \$



ÜRÜN KODU	888 049 050076
ÜRÜN ADI	45x45 ŞARJ PRİZİ USB+TYPE-C (A+C) 5V 4.2A
AMB. AD./KOLİ	10/200
FİYAT	27,54 \$

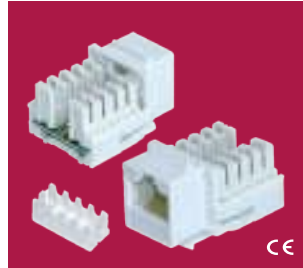

ÜRÜN KODU	888 049 050008
ÜRÜN ADI	DATA KONNEKTÖRÜ CAT 5e (RJ45)
AMB. AD./KOLİ	10/1000
FİYAT	1,23 \$



ÜRÜN KODU	888 049 050032
ÜRÜN ADI	DATA KONNEKTÖRÜ CAT 6e (RJ65 8)
AMB. AD./KOLİ	100/1000
FİYAT	1,25 \$



ÜRÜN KODU	888 049 050009
ÜRÜN ADI	TELEFON KONNEKTÖRÜ (RJ 11/12 6)
AMB. AD./KOLİ	100/1000
FİYAT	1,23 \$

## RACK KABİN PRİZ ve AKSESUARLARI



ÜRÜN KODU	075 171 222508
ÜRÜN ADI	16 MODÜL DÖŞEME ALTI PRİZ SİSTEMİ(BOŞ) 270x270
AMB. AD./KOLİ	1/10
FİYAT (₺)	1.626,43



ÜRÜN KODU	075 171 333308
ÜRÜN ADI	16 MODÜL DÖŞEME ALTI PRİZ SİSTEMİ BUATI 352x352
AMB. AD./KOLİ	1/5
FİYAT (₺)	1.654,71

## KABLO TOPLAMA SİRALI

Ürün Kodu	Ürün Adı	Amb. Birimi	Koli Adedi	Fiyat
888 020 900003	R1034 16 mm KABLO TOP. SPR. (1,5m VAK)	1 ad.	40	5,06 \$
888 020 900006	R1035 22 mm KABLO TOP. SPR. (1,5m VAK)	1 ad.	40	6,88 \$
888 020 900009	R1036 28 mm KABLO TOP. SPR. (1,5m VAK)	1 ad.	40	8,75 \$
888 020 900001	R1033 10 mm KABLO TOP. SPR. (50 mt.RULO)	1 mt.	300	2,51 \$
888 020 900004	R1034 16 mm KABLO TOP. SPR. (25 mt.RULO)	1 mt.	150	2,80 \$
888 020 900007	R1035 22 mm KABLO TOP. SPR. (25 mt.RULO)	1 mt.	100	3,91 \$
888 020 900010	R1036 28 mm KABLO TOP. SPR. (25 mt.RULO)	1 mt.	100	5,11 \$
888 020 900011	R1037 34 mm KABLO TOP. SPR. (25 mt.RULO)	1 mt.	50	6,38 \$



## KABLO OMURGA KANALI

Ürün Kodu	Ürün Adı	Amb. Birimi	Koli Adedi	Fiyat (₺)
888 020 200801	KABLO OMURGA KANALI - BEYAZ	1 ad.	30	429,02
888 020 200802	KABLO OMURGA KANALI - GRİ	1 ad.	30	406,61
888 020 200803	KABLO OMURGA KANALI - SİYAH	1 ad.	30	406,61



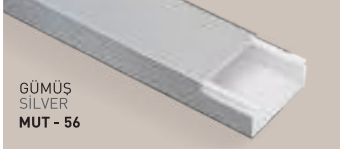
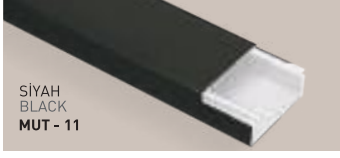

Ürün Kodu	Ürün Adı	Amb. Birimi (Kutu)	Amb. Birimi	Fiyat (₺)
-----------	----------	--------------------	-------------	-----------

### SİDEM SERİSİ RENKLİ KABLO KANALLARI

Ürün Kodu	Ürün Adı	Amb. Birimi (Kutu)	Amb. Birimi	Fiyat (₺)
001 007 010008 20 XX	10X8 MM KABLO KANALI (SİDEM)	330	mt.	53,61
001 007 012012 20 XX	12X12 MM KABLO KANALI (SİDEM)	250	mt.	47,30
001 007 015010 20 XX	15X10 MM KABLO KANALI (SİDEM)	250	mt.	42,25
001 007 016016 20 XX	16X16 MM KABLO KANALI (SİDEM)	250	mt.	59,09
001 007 020010 20 XX	20X10 MM KABLO KANALI (SİDEM)	200	mt.	46,74
001 007 025016 20 XX	25X16 MM KABLO KANALI (SİDEM)	150	mt.	72,90
001 007 025025 20 XX	25X25 MM KABLO KANALI (SİDEM)	100	mt.	95,45
001 007 930010 20 XX	30X10 MM KABLO KANALI (SİDEM) BÖLMELİ	140	mt.	79,96
001 007 930016 20 XX	30X16 MM KABLO KANALI (SİDEM) BÖLMELİ	140	mt.	105,79
001 007 030025 20 XX	30X25 MM KABLO KANALI (SİDEM)	80	mt.	117,23
001 007 040016 20 XX	40X16 MM KABLO KANALI (SİDEM)	100	mt.	95,11
001 007 940016 20 XX	40X16 MM KABLO KANALI (SİDEM)(BÖLMELİ)	100	mt.	114,16
001 007 040025 20 XX	40X25 MM KABLO KANALI (SİDEM)	80	mt.	124,66
001 007 040040 20 XX	40X40 MM KABLO KANALI (SİDEM)	50	mt.	138,05
001 007 960025 20 XX	60X25 MM KABLO KANALI (SİDEM) BÖLMELİ	40	mt.	197,68
001 007 060040 20 XX	60X40 MM KABLO KANALI (SİDEM)	40	mt.	176,55
001 007 060060 20 XX	60X60 MM KABLO KANALI (SİDEM)	32	mt.	273,97
001 007 080040 20 XX	80X40 MM KABLO KANALI (SİDEM)	30	mt.	267,20
001 007 080060 20 XX	80X60 MM KABLO KANALI (SİDEM)	24	mt.	300,40
001 007 100040 20 XX	100X40 MM KABLO KANALI (SİDEM)	24	mt.	332,95
001 007 100048 20 XX	100X48 MM KABLO KANALI (SİDEM)	24	mt.	348,67
001 007 100060 20 XX	100X60 MM KABLO KANALI (SİDEM)	20	mt.	411,78
001 007 075060 20 XX	75X60 MM KABLO KANALI (SİDEM)	30	mt.	302,76
001 007 100037 20 XX	100X37 MM KABLO KANALI (SİDEM) İ.KAPAKLI	30	mt.	351,21
001 007 100050 20 XX	100X50 MM KABLO KANALI (SİDEM) İ.KAPAKLI	20	mt.	366,14
001 007 120060 20 XX	120X60 MM KABLO KANALI (SİDEM) İ.KAPAKLI	16	mt.	505,24
001 007 120070 20 XX	120X70 MM KABLO KANALI (SİDEM)	16	mt.	681,93
001 007 170070 20 XX	170X70 MM KABLO KANALI (SİDEM)	12	mt.	827,75

### SİDEM SERİSİ RENKLİ KABLO KANALLARI (YAPIŞKANLI)

Ürün Kodu	Ürün Adı	Amb. Birimi (Kutu)	Amb. Birimi	Fiyat (₺)
001 155 010008 20 XX	10X8 MM KABLO KANALI (SİDEM) YAPIŞKANLI	330	mt.	53,73
001 155 012012 20 XX	12X12 MM KABLO KANALI (SİDEM) YAPIŞKANLI	250	mt.	50,30
001 155 015010 20 XX	15X10 MM KABLO KANALI (SİDEM) YAPIŞKANLI	250	mt.	50,79
001 155 016016 20 XX	16X16 MM KABLO KANALI (SİDEM) YAPIŞKANLI	240	mt.	61,71
001 155 020010 20 XX	20X10 MM KABLO KANALI (SİDEM) YAPIŞKANLI	180	mt.	51,37
001 155 025016 20 XX	25X16 MM KABLO KANALI (SİDEM) YAPIŞKANLI	150	mt.	76,41
001 155 025025 20 XX	25X25 MM KABLO KANALI (SİDEM) YAPIŞKANLI	100	mt.	101,72
001 155 930010 20 XX	30X10 MM KABLO KANALI (SİDEM) YAPIŞKANLI	140	mt.	71,64
001 155 930016 20 XX	30X16 MM KABLO KANALI (SİDEM) YAPIŞKANLI	140	mt.	92,30
001 155 030025 20 XX	30X25 MM KABLO KANALI (SİDEM) YAPIŞKANLI	80	mt.	119,67
001 155 040016 20 XX	40X16 MM KABLO KANALI (SİDEM) YAPIŞKANLI	100	mt.	151,78
001 155 040025 20 XX	40X25 MM KABLO KANALI (SİDEM) YAPIŞKANLI	80	mt.	139,43
001 155 040040 20 XX	40X40 MM KABLO KANALI (SİDEM) YAPIŞKANLI	50	mt.	151,82
001 155 960025 20 XX	60X25 MM KABLO KANALI (SİDEM) YAPIŞKANLI	40	mt.	213,90
001 155 060040 20 XX	60X40 MM KABLO KANALI (SİDEM) YAPIŞKANLI	40	mt.	207,03

### SİDEM SERİSİ SÜPÜRGELİKLER ve AKSESUARLARI

Ürün Kodu	Ürün Adı	Amb. Birimi (Kutu)	Amb. Birimi	Fiyat (₺)
001 007 974020 20 XX	74X20 MM KABLO KANALI (SİDEM) BÖLMELİ	50	mt.	162,81
001 007 975022 20 XX	75X22 MM KABLO KANALI (SİDEM) BÖLMELİ	50	mt.	243,86

### SİDEM SERİSİ BALIK SIRTI ZEMİN KANALLARI ve AKSESUARLARI

Ürün Kodu	Ürün Adı	Amb. Birimi (Kutu)	Amb. Birimi	Fiyat (₺)
001 007 050013 20 XX	50X13 MM KABLO KANALI (SİDEM)	60	mt.	136,12
001 007 060015 20 XX	60X15 MM KABLO KANALI (SİDEM)	40	mt.	148,30
001 031 060015 00 XX	60X15 MM L KÖŞE(SİDEM)	1	ad.	68,19
001 032 060015 00 XX	60X15 MM EK PARÇA (SİDEM)	1	ad.	42,00
001 033 060015 00 XX	60X15 MM SONLAMA KAPAĞI (SİDEM)	1	ad.	24,24
001 030 060015 00 XX	60X15 MM T KÖŞE (SİDEM)	1	ad.	77,06
001 007 075018 20 XX	75X18 MM KABLO KANALI (SİDEM)	30	mt.	213,01
001 007 090020 20 XX	90X20 MM KABLO KANALI (SİDEM)	20	mt.	313,48

### SİDEM SERİSİ BALIK SIRTI ZEMİN KANALLARI (YAPIŞKANLI)

Ürün Kodu	Ürün Adı	Amb. Birimi (Kutu)	Amb. Birimi	Fiyat (₺)
001 155 050013 20 XX	50X13 MM KABLO KANALI (SİDEM) YAPIŞKANLI	60	mt.	213,93
001 155 060015 20 XX	60X15 MM KABLO KANALI (SİDEM) YAPIŞKANLI	40	mt.	231,80
001 155 075018 20 XX	75X18 MM KABLO KANALI (SİDEM) YAPIŞKANLI	30	mt.	245,71

### 12x12 KANAL AKSESUARLARI - SİDEM SERİSİ

Ürün Kodu	Ürün Adı	Amb. Birimi (Kutu)	Amb. Birimi	Fiyat (₺)
001 028 012012 00 XX	12X12 MM (SİDEM) İÇ KÖŞE	1	ad.	35,71
001 029 012012 00 XX	12X12 MM (SİDEM) DIŞ KÖŞE	1	ad.	35,71
001 030 012012 00 XX	12X12 MM (SİDEM) T KÖŞE	1	ad.	35,26
001 031 012012 00 XX	12X12 MM (SİDEM) 90 L KÖŞE	1	ad.	35,26
001 033 012012 00 XX	12X12 MM (SİDEM) UÇ TAPA	1	ad.	23,94
001 032 012012 00 XX	12X12 MM (SİDEM) EK PARÇASI	1	ad.	23,94

### 15x10 KANAL AKSESUARLARI - SİDEM SERİSİ

Ürün Kodu	Ürün Adı	Amb. Birimi (Kutu)	Amb. Birimi	Fiyat (₺)
001 028 015010 00 XX	15X10 MM (SİDEM) İÇ KÖŞE	1	ad.	23,04
001 029 015010 00 XX	15X10 MM (SİDEM) DIŞ KÖŞE	1	ad.	23,04
001 030 015010 00 XX	15X10 MM (SİDEM) T KÖŞE	1	ad.	34,76
001 031 015010 00 XX	15X10 MM (SİDEM) 90 L KÖŞE	1	ad.	34,76
001 033 015010 00 XX	15X10 MM (SİDEM) UÇ TAPA	1	ad.	20,35
001 032 015010 00 XX	15X10 MM (SİDEM) EK PARÇASI	1	ad.	20,35

Ürün Kodu	Ürün Adı	Amb. (Kutu)	Amb. Birimi	Fiyat (₺)
<b>16x16 KANAL AKSESUARLARI - SİDEM SERİSİ</b>				€ €
001 028 016016 00 XX	16x16 MM (SİDEM) İÇ KÖŞE	1	ad.	22,10
001 029 016016 00 XX	16x16 MM (SİDEM) DIŞ KÖŞE	1	ad.	22,10
001 030 016016 00 XX	16x16 MM (SİDEM) T KÖŞE	1	ad.	41,91
001 031 016016 00 XX	16x16 MM (SİDEM) 90 L KÖŞE	1	ad.	41,91
001 033 016016 00 XX	16x16 MM (SİDEM) UÇ TAPA	1	ad.	20,85
001 032 016016 00 XX	16x16 MM (SİDEM) EK PARÇASI	1	ad.	20,85
<b>20x10 KANAL AKSESUARLARI - SİDEM SERİSİ</b>				€ €
001 028 020010 00 XX	20x10 MM (SİDEM) İÇ KÖŞE	1	ad.	33,01
001 029 020010 00 XX	20x10 MM (SİDEM) DIŞ KÖŞE	1	ad.	33,01
001 030 020010 00 XX	20x10 MM (SİDEM) T KÖŞE	1	ad.	34,52
001 031 020010 00 XX	20x10 MM (SİDEM) 90 L KÖŞE	1	ad.	34,52
001 033 020010 00 XX	20x10 MM (SİDEM) UÇ TAPA	1	ad.	23,40
001 032 020010 00 XX	20x10 MM (SİDEM) EK PARÇASI	1	ad.	23,40
<b>TAVAN KÖŞE KANALI (23x23) AKSESUARLARI -SİDEM SERİSİ</b>				€ €
001 041 023023 00 XX	23X23 MM T PARÇASI	1	ad.	94,11
001 042 023023 00 XX	23X23 MM 90 L KÖŞE	1	ad.	94,11
001 043 023023 00 XX	23X23 MM EK PARÇA	1	ad.	24,48
001 044 023023 00 XX	23X23 MM UÇ TAPA	1	ad.	24,48
<b>25x16 KANAL AKSESUARLARI - SİDEM SERİSİ</b>				€ €
001 028 025016 00 XX	25X16 MM (SİDEM) İÇ KÖŞE	1	ad.	44,04
001 029 025016 00 XX	25X16 MM (SİDEM) DIŞ KÖŞE	1	ad.	44,04
001 030 025016 00 XX	25X16 MM (SİDEM) T KÖŞE	1	ad.	47,32
001 031 025016 00 XX	25X16 MM (SİDEM) 90 L KÖŞE	1	ad.	47,32
001 033 025016 00 XX	25X16 MM (SİDEM) UÇ TAPA	1	ad.	28,88
001 032 025016 00 XX	25X16 MM (SİDEM) EK PARÇA	1	ad.	28,88
001 034 017421 00 XX	25X16 MM (SİDEM) PMK (45X45)	1	ad.	442,61
<b>25x25 KANAL AKSESUARLARI - SİDEM SERİSİ</b>				€ €
001 028 025025 00 XX	25x25 MM (SİDEM) İÇ KÖŞE	1	ad.	33,14
001 029 025025 00 XX	25x25 MM (SİDEM) DIŞ KÖŞE	1	ad.	33,14
001 030 025025 00 XX	25x25 MM (SİDEM) T PARÇASI	1	ad.	44,41
001 031 025025 00 XX	25x25 MM (SİDEM) 90 L KÖŞE	1	ad.	44,41
001 033 025025 00 XX	25x25 MM (SİDEM) UÇ TAPA	1	ad.	24,03
001 032 025025 00XX	25x25 MM (SİDEM) EK PARÇA	1	ad.	24,03
001 034 017421 00 XX	25x25 MM (SİDEM) PMK (45X45)	1	ad.	442,61
<b>30x10 KANAL AKSESUARLARI - SİDEM SERİSİ</b>				€ €
001 028 030010 00 XX	30X10 MM (SİDEM) İÇ KÖŞE	1	ad.	44,11
001 029 030010 00 XX	30X10 MM (SİDEM) DIŞ KÖŞE	1	ad.	44,11
001 030 030010 00 XX	30X10 MM (SİDEM) T PARÇASI	1	ad.	55,79
001 031 030010 00 XX	30X10 MM (SİDEM) 90 L KÖŞE	1	ad.	55,79
001 033 030010 00 XX	30X10 MM (SİDEM) UÇ TAPA	1	ad.	25,90
001 032 030010 00 XX	30X10 MM (SİDEM) EK PARÇA	1	ad.	25,90
<b>30x16 KANAL AKSESUARLARI - SİDEM SERİSİ</b>				€ €
001 028 030016 00 XX	30x16 MM (SİDEM) İÇ KÖŞE	1	ad.	50,94
001 029 030016 00 XX	30x16 MM (SİDEM) DIŞ KÖŞE	1	ad.	50,94
001 030 030016 00 XX	30x16 MM (SİDEM) T PARÇASI	1	ad.	68,53
001 031 030016 00 XX	30x16 MM (SİDEM) 90 L KÖŞE	1	ad.	68,53
001 033 030016 00 XX	30x16 MM (SİDEM) UÇ TAPA	1	ad.	28,83
001 032 030016 00 XX	30x16 MM (SİDEM) EK PARÇA	1	ad.	28,83
<b>30x25 KANAL AKSESUARLARI - SİDEM SERİSİ</b>				€ €
001 028 030025 00 XX	30X25 MM (SİDEM) İÇ KÖŞE	1	ad.	49,64
001 029 030025 00 XX	30X25 MM (SİDEM) DIŞ KÖŞE	1	ad.	49,64
001 030 030025 00 XX	30X25 MM (SİDEM) T PARÇASI	1	ad.	69,37
001 031 030025 00 XX	30X25 MM (SİDEM) 90 L KÖŞE	1	ad.	69,37
001 033 030025 00 XX	30X25 MM (SİDEM) UÇ TAPA	1	ad.	30,26
001 032 030025 00 XX	30X25 MM (SİDEM) EK PARÇA	1	ad.	30,26
<b>40x16 KANAL AKSESUARLARI - SİDEM SERİSİ</b>				€ €
001 028 040016 00 XX	40x16 MM (SİDEM) İÇ KÖŞE	1	ad.	52,57
001 029 040016 00 XX	40x16 MM (SİDEM) DIŞ KÖŞE	1	ad.	52,57
001 030 040016 00 XX	40x16 MM (SİDEM) T PARÇASI	1	ad.	73,13
001 031 040016 00 XX	40x16 MM (SİDEM) 90 L KÖŞE	1	ad.	73,13
001 033 040016 00 XX	40x16 MM (SİDEM) UÇ TAPA	1	ad.	36,94
001 032 040016 00 XX	40x16 MM (SİDEM) EK PARÇA	1	ad.	36,94
001 034 017421 00 XX	40X16 MM (SİDEM) PMK (45X45)	1	ad.	442,61
<b>40x25 KANAL AKSESUARLARI - SİDEM SERİSİ</b>				€ €
001 028 040025 00 XX	40X25 MM (SİDEM) İÇ KÖŞE	1	ad.	60,89
001 029 040025 00 XX	40X25 MM (SİDEM) DIŞ KÖŞE	1	ad.	60,89
001 030 040025 00 XX	40X25 MM (SİDEM) T KÖŞE	1	ad.	76,05
001 031 040025 00 XX	40X25 MM (SİDEM) 90 L KÖŞE	1	ad.	76,05
001 033 040025 00 XX	40X25 MM (SİDEM) UÇ TAPA	1	ad.	40,66
001 032 040025 00 XX	40X25 MM (SİDEM) EK PARÇASI	1	ad.	40,66
001 034 017421 00 XX	40X25 MM (SİDEM) PMK (45X45)	1	ad.	442,61







İÇ KÖŞE



DIŞ KÖŞE



T KÖŞE



L KÖŞE

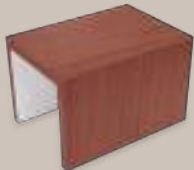

EK PARÇA



UÇ TAPA

Ürün Kodu	Ürün Adı	Amb. (Kutu)	Amb. Birimi	Fiyat (₺)
<b>40x40 KANAL AKSESUARLARI - SİDEM SERİSİ</b>				
C €				
001 028 040040 00 XX	40x40 MM (SİDEM) İÇ KÖŞE	1	ad.	64,35
001 029 040040 00 XX	40x40 MM (SİDEM) DIŞ KÖŞE	1	ad.	64,35
001 030 040040 00 XX	40x40 MM (SİDEM) T KÖŞE	1	ad.	67,52
001 031 040040 00 XX	40x40 MM (SİDEM) 90 L KÖŞE	1	ad.	67,51
001 033 040040 00 XX	40x40 MM (SİDEM) UÇ TAPA	1	ad.	49,01
001 032 040040 00 XX	40x40 MM (SİDEM) EK PARÇASI	1	ad.	49,01
001 034 017421 00 XX	40x40 MM (SİDEM) PMK (45X45)	1	ad.	442,61
<b>60x25 KANAL AKSESUARLARI - SİDEM SERİSİ</b>				
C €				
001 028 060025 00 XX	60x25 MM (SİDEM) İÇ KÖŞE	1	ad.	67,70
001 029 060025 00 XX	60x25 MM (SİDEM) DIŞ KÖŞE	1	ad.	67,70
001 030 060025 00 XX	60x25 MM (SİDEM) T KÖŞE	1	ad.	72,91
001 031 060025 00 XX	60x25 MM (SİDEM) 90 L KÖŞE	1	ad.	72,91
001 033 060025 00 XX	60x25 MM (SİDEM) UÇ TAPA	1	ad.	49,30
001 032 060025 00 XX	60x25 MM (SİDEM) EK PARÇASI	1	ad.	49,30
<b>60x40 KANAL AKSESUARLARI - SİDEM SERİSİ</b>				
C €				
001 028 060040 00 XX	60x40 MM (SİDEM) İÇ KÖŞE	1	ad.	68,53
001 029 060040 00 XX	60x40 MM (SİDEM) DIŞ KÖŞE	1	ad.	68,53
001 030 060040 00 XX	60x40 MM (SİDEM) T KÖŞE	1	ad.	71,87
001 031 060040 00 XX	60x40 MM (SİDEM) 90 L KÖŞE	1	ad.	71,87
001 033 060040 00 XX	60x40 MM (SİDEM) UÇ TAPA	1	ad.	50,02
001 032 060040 00 XX	60x40 MM (SİDEM) EK PARÇA	1	ad.	50,02
<b>60x60 KANAL AKSESUARLARI - SİDEM SERİSİ</b>				
C €				
001 028 060060 00 XX	60x60 MM (SİDEM) İÇ KÖŞE	1	ad.	85,16
001 029 060060 00 XX	60x60 MM (SİDEM) DIŞ KÖŞE	1	ad.	85,16
001 030 060060 00 XX	60x60 MM (SİDEM) T PARÇASI	1	ad.	98,03
001 031 060060 00 XX	60x60 MM (SİDEM) 90 L KÖŞE	1	ad.	98,03
001 033 060060 00 XX	60x60 MM (SİDEM) UÇ TAPA	1	ad.	58,42
001 032 060060 00 XX	60x60 MM (SİDEM) EK PARÇA	1	ad.	58,42
<b>74x20 KANAL AKSESUARLARI - SİDEM SERİSİ</b>				
C €				
001 028 074020 00 XX	74x20 MM (SİDEM) İÇ KÖŞE	1	ad.	70,95
001 029 074020 00 XX	74x20 MM (SİDEM) DIŞ KÖŞE	1	ad.	70,95
001 030 074020 00 XX	74x20 MM (SİDEM) T PARÇASI	1	ad.	74,00
001 031 074020 00 XX	74x20 MM (SİDEM) 90 L KÖŞE	1	ad.	73,99
001 032 074020 00 XX	74x20 MM (SİDEM) UÇ TAPA	1	ad.	67,19
001 033 074020 00 XX	74x20 MM (SİDEM) EK PARÇA	1	ad.	67,19
001 036 017420 00 XX	74x20 MM (SİDEM) PRİZ MONTAJ KASASI	1	ad.	726,53
<b>75x22 KANAL AKSESUARLARI - SİDEM SERİSİ</b>				
C €				
001 028 075022 00 XX	75x22 MM (SİDEM) İÇ KÖŞE	1	ad.	65,39
001 029 075022 00 XX	75x22 MM (SİDEM) DIŞ KÖŞE	1	ad.	65,39
001 033 075022 01 XX	75x22 MM (SİDEM) SAĞ SONLAMA	1	ad.	89,59
001 033 075022 02 XX	75x22 MM (SİDEM) SOL SONLAMA	1	ad.	89,59
001 032 075022 00 XX	75x22 MM (SİDEM) EK PARÇASI	1	ad.	59,33
<b>80x40 KANAL AKSESUARLARI - SİDEM SERİSİ</b>				
C €				
001 028 080040 00 XX	80x40 MM (SİDEM) İÇ KÖŞE	1	ad.	83,49
001 029 080040 00 XX	80x40 MM (SİDEM) DIŞ KÖŞE	1	ad.	83,49
001 030 080040 00 XX	80x40 MM (SİDEM) T PARÇASI	1	ad.	91,31
001 031 080040 00 XX	80x40 MM (SİDEM) 90 L KÖŞE	1	ad.	91,31
001 033 080040 00 XX	80x40 MM (SİDEM) UÇ TAPA	1	ad.	77,09
001 032 080040 00 XX	80x40 MM (SİDEM) EK PARÇA	1	ad.	77,09
<b>80x60 KANAL AKSESUARLARI - SİDEM SERİSİ</b>				
C €				
001 028 080060 00 XX	80x60 MM (SİDEM) İÇ KÖŞE	1	ad.	108,73
001 029 080060 00 XX	80x60 MM (SİDEM) DIŞ KÖŞE	1	ad.	108,73
001 030 080060 00 XX	80x60 MM (SİDEM) T PARÇASI	1	ad.	95,11
001 031 080060 00 XX	80x60 MM (SİDEM) 90 L KÖŞE	1	ad.	95,11
001 033 080060 00 XX	80x60 MM (SİDEM) UÇ TAPA	1	ad.	68,32
001 032 080060 00 XX	80x60 MM (SİDEM) EK PARÇA	1	ad.	68,32

Ürün Kodu	Ürün Adı	Amb. (Kutu)	Amb. Birimi	Fiyat (₺)
<b>100x37 KANAL AKSESUARLARI - SİDEM SERİSİ</b>				€ €
001 028 100037 00 XX	100X37 MM (SİDEM) İÇ KÖŞE (SABİT)	1	ad.	134,13
001 029 100037 00 XX	100X37 MM (SİDEM) DIŞ KÖŞE (SABİT)	1	ad.	134,13
001 028 100037 01 XX	100X37 MM (SİDEM) İÇ KÖŞE (HAREKETLİ)	1	ad.	134,13
001 029 100037 01 XX	100X37 MM (SİDEM) DIŞ KÖŞE (HAREKETLİ)	1	ad.	134,13
001 030 100037 00 XX	100X37 MM (SİDEM) T PARÇASI	1	ad.	142,90
001 031 100037 00 XX	100X37 MM (SİDEM) 90 L KÖŞE	1	ad.	142,90
001 033 100037 00 XX	100X37 MM (SİDEM) UÇ TAPA	1	ad.	93,60
001 032 100037 00 XX	100X37 MM (SİDEM) EK PARÇA	1	ad.	93,60
<b>100x40 KANAL AKSESUARLARI - SİDEM SERİSİ</b>				€ €
001 028 100040 00 XX	100X40 MM (SİDEM) İÇ KÖŞE (SABİT)	1	ad.	139,86
001 029 100040 00 XX	100X40 MM (SİDEM) DIŞ KÖŞE (SABİT)	1	ad.	139,86
001 028 100040 01 XX	100X40 MM (SİDEM) İÇ KÖŞE (HAREKETLİ)	1	ad.	139,86
001 029 100040 01 XX	100X40 MM (SİDEM) DIŞ KÖŞE (HAREKETLİ)	1	ad.	139,86
001 030 100040 00 XX	100X40 MM (SİDEM) T PARÇASI	1	ad.	145,42
001 031 100040 00 XX	100X40 MM (SİDEM) 90 L KÖŞE	1	ad.	145,42
001 033 100040 00 XX	100X40 MM (SİDEM) UÇ TAPA	1	ad.	95,14
001 032 100040 00 XX	100X40 MM (SİDEM) EK PARÇA	1	ad.	95,14
<b>100x48 KANAL AKSESUARLARI - SİDEM SERİSİ</b>				€ €
001 028 100048 00 XX	100X48 MM (SİDEM) İÇ KÖŞE (SABİT)	1	ad.	151,06
001 029 100048 00 XX	100X48 MM (SİDEM) DIŞ KÖŞE (SABİT)	1	ad.	151,06
001 028 100048 01 XX	100X48 MM (SİDEM) İÇ KÖŞE (HAREKETLİ)	1	ad.	151,06
001 029 100048 01 XX	100X48 MM (SİDEM) DIŞ KÖŞE (HAREKETLİ)	1	ad.	151,06
001 030 100048 00 XX	100X48 MM (SİDEM) T PARÇASI	1	ad.	156,28
001 031 100048 00 XX	100X48 MM (SİDEM) 90 L KÖŞE	1	ad.	156,28
001 033 100048 00 XX	100X48 MM (SİDEM) UÇ TAPA	1	ad.	101,12
001 032 100048 00 XX	100X48 MM (SİDEM) EK PARÇA	1	ad.	101,12
<b>100x50 KANAL AKSESUARLARI - SİDEM SERİSİ</b>				€ €
001 028 100050 00 XX	100X50 MM (SİDEM) İÇ KÖŞE (SABİT)	1	ad.	161,00
001 029 100050 00 XX	100X50 MM (SİDEM) DIŞ KÖŞE (SABİT)	1	ad.	161,00
001 028 100050 01 XX	100X50 MM (SİDEM) İÇ KÖŞE (HAREKETLİ)	1	ad.	161,00
001 029 100050 01 XX	100X50 MM (SİDEM) DIŞ KÖŞE (HAREKETLİ)	1	ad.	161,00
001 030 100050 00 XX	100X50 MM (SİDEM) T PARÇASI	1	ad.	164,63
001 031 100050 00 XX	100X50 MM (SİDEM) 90 L KÖŞE	1	ad.	164,63
001 033 100050 00 XX	100X50 MM (SİDEM) UÇ TAPA	1	ad.	106,97
001 032 100050 00 XX	100X50 MM (SİDEM) EK PARÇA	1	ad.	106,97
<b>100x60 KANAL AKSESUARLARI - SİDEM SERİSİ</b>				€ €
001 028 100060 00 XX	100X60 MM (SİDEM) İÇ KÖŞE (SABİT)	1	ad.	181,77
001 029 100060 00 XX	100X60 MM (SİDEM) DIŞ KÖŞE (SABİT)	1	ad.	181,77
001 028 100060 01 XX	100X60 MM (SİDEM) İÇ KÖŞE (HAREKETLİ)	1	ad.	181,77
001 029 100060 01 XX	100X60 MM (SİDEM) DIŞ KÖŞE (HAREKETLİ)	1	ad.	181,77
001 030 100060 00 XX	100X60 MM (SİDEM) T PARÇASI	1	ad.	197,98
001 031 100060 00 XX	100X60 MM (SİDEM) 90 L KÖŞE	1	ad.	197,98
001 033 100060 00 XX	100X60 MM (SİDEM) UÇ TAPA	1	ad.	117,25
001 032 100060 00 XX	100X60 MM (SİDEM) EK PARÇA	1	ad.	117,25
<b>İÇTEN KAPAKLI 100x37/50 İÇİN PMS - SİDEM SERİSİ</b>				€ €
001 034 400001 00 XX	100X37/50 (SİDEM) 45X45 PMS TEKLİ	1	ad.	88,93
001 034 400002 00 XX	100X37/50 (SİDEM) 45X45 PMS İKİLİ	1	ad.	94,85
001 034 400003 00 XX	100X37/50 (SİDEM) 45X45 PMS ÜÇLÜ	1	ad.	99,63
001 034 400004 00 XX	100X37/50 (SİDEM) 45X45 PMS DÖRTLÜ	1	ad.	150,80
001 034 500001 00 XX	100X37/50 (SİDEM) 55X55 PMS TEKLİ	1	ad.	127,24
001 034 500002 00 XX	100X37/50 (SİDEM) 55X55 PMS İKİLİ	1	ad.	146,60
001 034 500003 00 XX	100X37/50 (SİDEM) 55X55 PMS ÜÇLÜ	1	ad.	158,78
<b>DIŞTAN KAPAKLI 100'LÜK PMS 55x55 İÇİN - SİDEM SERİSİ</b>				€ €
001 034 000001 00 XX	100'LÜK 55X55 PMS TEKLİ SİDEM	1	ad.	165,75
001 034 000002 00 XX	100'LÜK 55X55 PMS İKİLİ SİDEM	1	ad.	202,42
001 034 000003 00 XX	100'LÜK 55X55 PMS ÜÇLÜ SİDEM	1	ad.	229,72
<b>DIŞTAN KAPAKLI 100'LÜK PMS 45x45 İÇİN - SİDEM SERİSİ</b>				€ €
001 034 100001 00 XX	100'LÜK 45X45 PMS TEKLİ SİDEM	1	ad.	107,07
001 034 100002 00 XX	100'LÜK 45X45 PMS İKİLİ SİDEM	1	ad.	137,10
001 034 100003 00 XX	100'LÜK 45X45 PMS ÜÇLÜ SİDEM	1	ad.	195,21
001 034 100004 00 XX	100'LÜK 45X45 PMS DÖRTLÜ SİDEM	1	ad.	207,14



İÇ KÖŞE



DIŞ KÖŞE



T KÖŞE



L KÖŞE



\*Kutusuz ürünlerde topraklama klemensi bulunmamaktadır.



Siva altı serisinde **betopan**, **alçıpan** duvarlara montaj yapılabilmektedir.



Ürün Kodu	Ürün Adı	Kutu Adet	Koli Adet	Normal Fiyat (₺)	Kutusuz ve Klemensiz Fiyat (₺)
<b>COMFORT W OTOMAT KUTULARI</b>					
IP40					
001 057 200001 00 00	COMFORT MÜH. SİGORTA KUTUSU(S/Ü) 1 Lİ	20	120	22,90	-
001 057 200002 00 00	COMFORT MÜH. SİGORTA KUTUSU(S/Ü) 1-2 Lİ	20	80	27,85	-
001 057 200004 00 00	COMFORT MÜH. SİGORTA KUTUSU(S/Ü) 2-4 Lİ	10	60	41,93	-
001 057 100006 00 00	COMFORT SİGORTA KUTUSU (S/Ü) 6 Lİ	1	20	221,41	177,15
001 057 100009 00 00	COMFORT SİGORTA KUTUSU (S/Ü) 9 LU	1	20	276,98	223,51
001 057 100012 00 00	COMFORT SİGORTA KUTUSU (S/Ü) 12 Lİ	1	10	336,31	281,04
001 057 100018 00 00	COMFORT SİGORTA KUTUSU (S/Ü) 18 Lİ	1	10	470,58	388,45
001 057 100024 00 00	COMFORT SİGORTA KUTUSU (S/Ü) 24 LÜ	1	5	604,58	498,90
001 057 100036 00 00	COMFORT SİGORTA KUTUSU (S/Ü) 36 Lİ	1	5	777,42	678,27
001 057 000006 00 00	COMFORT SİGORTA KUTUSU (S/A) 6 Lİ	1	20	220,77	176,52
001 057 000009 00 00	COMFORT SİGORTA KUTUSU (S/A) 9 LU	1	20	275,48	223,29
001 057 000012 00 00	COMFORT SİGORTA KUTUSU (S/A) 12 Lİ	1	10	334,96	280,17
001 057 000018 00 00	COMFORT SİGORTA KUTUSU (S/A) 18 Lİ	1	10	469,30	385,53
001 057 000024 00 00	COMFORT SİGORTA KUTUSU (S/A) 24 LÜ	1	5	602,82	498,82
001 057 000036 00 00	COMFORT SİGORTA KUTUSU (S/A) 36 Lİ	1	5	775,54	676,74
<b>COMFORT W OTOMAT KUTULARI - ALEV YAYMAYAN</b>					
IP40					
001 057 210001 00 00	COMFORT MÜH. SİGORTA (A.YAYMAYAN)(S/Ü) 1 Lİ	20	120	58,62	-
001 057 210002 00 00	COMFORT MÜH. SİGORTA (A.YAYMAYAN)(S/Ü) 1-2 Lİ	20	80	69,90	-
001 057 210004 00 00	COMFORT MÜH. SİGORTA (A.YAYMAYAN)(S/Ü) 2-4 LÜ	10	60	85,03	-
001 057 110006 00 00	COMFORT SİGORTA KUTUSU(S/Ü)(A.YAYMAYAN) 6 Lİ	1	20	368,57	-
001 057 110009 00 00	COMFORT SİGORTA KUTUSU(S/Ü)(A.YAYMAYAN) 9 LU	1	20	446,93	-
001 057 110012 00 00	COMFORT SİGORTA KUTUSU(S/Ü)(A.YAYMAYAN) 12 Lİ	1	10	592,02	-
001 057 110018 00 00	COMFORT SİGORTA KUTUSU(S/Ü)(A.YAYMAYAN) 18 Lİ	1	10	858,38	-
001 057 110024 00 00	COMFORT SİGORTA KUTUSU(S/Ü)(A.YAYMAYAN) 24 LÜ	1	5	948,75	-
001 057 110036 00 00	COMFORT SİGORTA KUTUSU(S/Ü)(A.YAYMAYAN) 36 Lİ	1	5	1.288,90	-
001 057 010006 00 00	COMFORT SİGORTA KUTUSU(S/A) A.YAYMAYAN 6 Lİ	1	20	354,30	-
001 057 010009 00 00	COMFORT SİGORTA KUTUSU(S/A) A.YAYMAYAN 9 LU	1	20	434,90	-
001 057 010012 00 00	COMFORT SİGORTA KUTUSU(S/A) A.YAYMAYAN 12 Lİ	1	10	575,89	-
001 057 010018 00 00	COMFORT SİGORTA KUTUSU(S/A) A.YAYMAYAN 18 Lİ	1	10	833,59	-
001 057 010024 00 00	COMFORT SİGORTA KUTUSU(S/A) A.YAYMAYAN 24 LÜ	1	5	928,07	-
001 057 010036 00 00	COMFORT SİGORTA KUTUSU(S/A) A.YAYMAYAN 36 Lİ	1	5	1.266,24	-
<b>COMFORT W OTOMAT KUTULARI - HALOJEN FREE - ALEV YAYAN</b>					
IP40 HF					
001 057 220001 00 00	COMFORT MÜH. SİGORTA KUTUSU H.FREE (ALEV YAYAN)(S/Ü)1 Lİ	20	120	32,77	-
001 057 220002 00 00	COMFORT MÜH. SİGORTA KUTUSU H.FREE (ALEV YAYAN)(S/Ü)1-2 Lİ	20	80	40,94	-
001 057 220004 00 00	COMFORT MÜH. SİGORTA KUTUSU H.FREE (ALEV YAYAN)(S/Ü)2-4 Lİ	10	60	52,39	-
001 057 120006 00 00	COMFORT SİGORTA KUTUSU H.FREE (ALEV YAYAN) (S/Ü) 6 Lİ	1	20	240,45	-
001 057 120009 00 00	COMFORT SİGORTA KUTUSU H.FREE (ALEV YAYAN) (S/Ü) 9 LU	1	20	282,68	-
001 057 120012 00 00	COMFORT SİGORTA KUTUSU H.FREE (ALEV YAYAN) (S/Ü) 12 Lİ	1	10	379,90	-
001 057 120018 00 00	COMFORT SİGORTA KUTUSU H.FREE (ALEV YAYAN) (S/Ü) 18 Lİ	1	10	527,87	-
001 057 120024 00 00	COMFORT SİGORTA KUTUSU H.FREE (ALEV YAYAN) (S/Ü) 24 LÜ	1	5	693,30	-
001 057 120036 00 00	COMFORT SİGORTA KUTUSU H.FREE (ALEV YAYAN) (S/Ü) 36 Lİ	1	5	767,06	-
001 057 020006 00 00	COMFORT SİGORTA KUTUSU H.FREE (ALEV YAYAN) (S/A) 6 Lİ	1	20	234,74	-
001 057 020009 00 00	COMFORT SİGORTA KUTUSU H.FREE (ALEV YAYAN) (S/A) 9 LU	1	20	277,72	-
001 057 020012 00 00	COMFORT SİGORTA KUTUSU H.FREE (ALEV YAYAN) (S/A) 12 Lİ	1	10	375,90	-
001 057 020018 00 00	COMFORT SİGORTA KUTUSU H.FREE (ALEV YAYAN) (S/A) 18 Lİ	1	10	521,87	-
001 057 020024 00 00	COMFORT SİGORTA KUTUSU H.FREE (ALEV YAYAN) (S/A) 24 LÜ	1	5	685,42	-
001 057 020036 00 00	COMFORT SİGORTA KUTUSU H.FREE (ALEV YAYAN) (S/A) 36 Lİ	1	5	758,47	-
<b>COMFORT W OTOMAT ZAYIF AKIM KUTULARI</b>					
IP40					
001 057 101012 00 00	COMFORT ZAYIF AKIM KUTUSU (S/Ü)(225x270)	1	10	305,59	-
001 057 101020 00 00	COMFORT ZAYIF AKIM KUTUSU (S/Ü)(270x340)	1	5	530,06	-
001 057 101024 00 00	COMFORT 12 Lİ SİGORTA + ZAYIF AKIM KUTUSU (S/Ü)	1	5	555,97	-
001 057 101036 00 00	COMFORT 24 LÜ SİGORTA + ZAYIF AKIM KUTUSU (S/Ü)	1	5	710,54	-
001 057 001012 00 00	COMFORT ZAYIF AKIM KUTUSU (S/A)(205x250)	1	10	301,99	-
001 057 001020 00 00	COMFORT ZAYIF AKIM KUTUSU (S/A)(248x318)	1	5	528,10	-
001 057 001024 00 00	COMFORT 12 Lİ SİGORTA + ZAYIF AKIM KUTUSU (S/A)	1	5	553,01	-
001 057 001036 00 00	COMFORT 24 LÜ SİGORTA + ZAYIF AKIM KUTUSU (S/A)	1	5	718,23	-
<b>COMFORT W OTOMAT ZAYIF AKIM KUTULARI - HALOJEN FREE - ALEV YAYAN</b>					
IP40 HF					
001 057 121012 00 00	COMFORT ZAYIF AKIM KUTUSU H.FREE (ALEV YAYAN) (S/Ü)(225x270)	1	10	356,07	-
001 057 121020 00 00	COMFORT ZAYIF AKIM KUTUSU H.FREE (ALEV YAYAN) (S/Ü)(270x340)	1	5	606,73	-
001 057 121024 00 00	COMFORT 12 Lİ SİGORTA + ZAYIF AKIM KUTUSU H.FREE (ALEV YAYAN) (S/Ü)	1	5	639,00	-
001 057 121036 00 00	COMFORT 24 LÜ SİGORTA + ZAYIF AKIM KUTUSU H.FREE (ALEV YAYAN) (S/Ü)	1	5	783,64	-
001 057 021012 00 00	COMFORT ZAYIF AKIM KUTUSU H.FREE (ALEV YAYAN) (S/A)(205x250)	1	10	352,46	-
001 057 021020 00 00	COMFORT ZAYIF AKIM KUTUSU H.FREE (ALEV YAYAN) (S/A)(248x318)	1	5	519,45	-
001 057 021024 00 00	COMFORT 12 Lİ SİGORTA + ZAYIF AKIM KUTUSU H.FREE (ALEV YAYAN) (S/A)	1	5	630,31	-
001 057 021036 00 00	COMFORT 24 LÜ SİGORTA + ZAYIF AKIM KUTUSU H.FREE (ALEV YAYAN) (S/A)	1	5	778,28	-
<b>COMFORT W OTOMAT ZAYIF AKIM KUTULARI - ALEV YAYMAYAN</b>					
IP40					
001 057 111012 00 00	COMFORT ZAYIF AKIM KUTUSU(A.YAYMAYAN)(S/Ü)(225x270)	1	10	512,38	-
001 057 111020 00 00	COMFORT ZAYIF AKIM KUTUSU(A.YAYMAYAN)(S/Ü)(270x340)	1	5	841,27	-
001 057 111024 00 00	COMFORT 12 Lİ SİGORTA + ZAYIF AKIM KUTUSU(A.YAYMAYAN)(S/Ü)	1	5	818,24	-
001 057 111036 00 00	COMFORT 24 LÜ SİGORTA + ZAYIF AKIM KUTUSU(A.YAYMAYAN)(S/Ü)	1	5	1.046,55	-
001 057 011012 00 00	COMFORT ZAYIF AKIM KUTUSU(A.YAYMAYAN)(S/A)(205x250)	1	10	483,24	-
001 057 011020 00 00	COMFORT ZAYIF AKIM KUTUSU(A.YAYMAYAN)(S/A)(248x318)	1	5	797,56	-
001 057 011024 00 00	COMFORT 12 Lİ SİGORTA + ZAYIF AKIM KUTUSU(A.YAYMAYAN)(S/A)	1	5	775,05	-
001 057 011036 00 00	COMFORT 24 LÜ SİGORTA + ZAYIF AKIM KUTUSU(A.YAYMAYAN)(S/A)	1	5	1.007,66	-
<b>COMFORT W OTOMAT KUTUSU AKSESUARLARI</b>					
001 057 990001 00 00	S/A COMFORT ALÇIPAN MONTAJ SETİ	1		29,71	-
001 057 990002 00 00	COMFORT SU TERAZİSİ	1		42,82	-
000 700 000574 00 00	RAY YÜKSELTME PARÇASI (UZUN/KISA)	1		5,18	-
001 057 001236 00 00	COMFORT ZAYIF AKIM ÖRTME PARÇASI	50		29,72	-

Ürün Kodu	Ürün Adı	Kutu Adet	Koli Adet	Kutu Fiyat (₺)
-----------	----------	-----------	-----------	----------------

### W OTOMAT ÖRTME PARÇALARI

001 026 000002 00 00	W OTOMAT ÖRTME PARÇASI 12'Lİ - YENİ TİP	50	400	20,78
----------------------	---	----	-----	-------

### MEKSBOX W OTOMAT KUTULARI

IP30

001 027 200001 00 00	MÜHÜRLÜ W OTOMAT KUTUSU (S/Ü) 1 Lİ	20	160	20,91
001 027 200002 00 00	MÜHÜRLÜ W OTOMAT KUTUSU (S/Ü) 2 Lİ	20	80	25,22
001 027 200004 00 00	MÜHÜRLÜ W OTOMAT KUTUSU (S/Ü) 4 LÜ	10	80	40,23
001 027 100002 00 00	W OTOMAT KUTUSU (S/Ü) MEKSBOX 2 Lİ	1	30	171,46
001 027 000002 00 00	W OTOMAT KUTUSU (S/A) MEKSBOX 2 Lİ	1	30	169,98
001 027 100004 00 00	W OTOMAT KUTUSU (S/Ü) MEKSBOX 4 LÜ	1	20	179,50
001 027 000004 00 00	W OTOMAT KUTUSU (S/A) MEKSBOX 4 LÜ	1	20	177,38
001 027 100006 00 00	W OTOMAT KUTUSU (S/Ü) MEKSBOX 6 Lİ	1	20	214,90
001 027 000006 00 00	W OTOMAT KUTUSU (S/A) MEKSBOX 6 Lİ	1	20	212,34
001 027 100009 00 00	W OTOMAT KUTUSU (S/Ü) MEKSBOX 9 LU	1	20	269,10
001 027 000009 00 00	W OTOMAT KUTUSU (S/A) MEKSBOX 9 LU	1	20	265,36
001 027 100012 00 00	W OTOMAT KUTUSU (S/Ü) MEKSBOX 12 Lİ	1	10	332,53
001 027 000012 00 00	W OTOMAT KUTUSU (S/A) MEKSBOX 12 Lİ	1	10	330,48
001 027 100016 00 00	W OTOMAT KUTUSU (S/Ü) MEKSBOX 16 Lİ	1	10	451,31
001 027 000016 00 00	W OTOMAT KUTUSU (S/A) MEKSBOX 16 Lİ	1	10	449,79
001 027 100024 00 00	W OTOMAT KUTUSU (S/Ü) MEKSBOX 24 LÜ	1	5	570,52
001 027 000024 00 00	W OTOMAT KUTUSU (S/A) MEKSBOX 24 LÜ	1	5	568,84
001 027 100036 00 00	W OTOMAT KUTUSU (S/Ü) MEKSBOX 36 Lİ	1	5	746,97
001 027 000036 00 00	W OTOMAT KUTUSU (S/A) MEKSBOX 36 Lİ	1	5	744,33

### MEKSBOX W OTOMAT KUTULARI - ALEV YAYMAYAN

TS CE IP30

001 027 210001 00 00	MÜH.W OTOMAT KUTUSU ALEV YAYMAYAN (S/Ü) 1 Lİ	20	160	45,31
001 027 210002 00 00	MÜH.W OTOMAT KUTUSU ALEV YAYMAYAN (S/Ü) 2 Lİ	20	80	66,71
001 027 210004 00 00	MÜH.W OTOMAT KUTUSU ALEV YAYMAYAN (S/Ü) 4 LÜ	10	80	76,22
001 027 110002 00 00	W OTOMAT KUTUSU (S/Ü) ALEV YAYMAYAN 2 Lİ	1	30	267,81
001 027 010002 00 00	W OTOMAT KUTUSU (S/A) ALEV YAYMAYAN 2 Lİ	1	30	261,64
001 027 110004 00 00	W OTOMAT KUTUSU (S/Ü) ALEV YAYMAYAN 4 LÜ	1	20	285,50
001 027 010004 00 00	W OTOMAT KUTUSU (S/A) ALEV YAYMAYAN 4 LÜ	1	20	267,76
001 027 110006 00 00	W OTOMAT KUTUSU (S/Ü) ALEV YAYMAYAN 6 Lİ	1	20	336,90
001 027 010006 00 00	W OTOMAT KUTUSU (S/A) ALEV YAYMAYAN 6 Lİ	1	20	322,13
001 027 110009 00 00	W OTOMAT KUTUSU (S/Ü) ALEV YAYMAYAN 9 LU	1	20	424,52
001 027 010009 00 00	W OTOMAT KUTUSU (S/A) ALEV YAYMAYAN 9 LU	1	20	409,98
001 027 110012 00 00	W OTOMAT KUTUSU (S/Ü) ALEV YAYMAYAN 12 Lİ	1	10	570,85
001 027 010012 00 00	W OTOMAT KUTUSU (S/A) ALEV YAYMAYAN 12 Lİ	1	10	556,09
001 027 110016 00 00	W OTOMAT KUTUSU (S/Ü) ALEV YAYMAYAN 16 Lİ	1	10	662,92
001 027 010016 00 00	W OTOMAT KUTUSU (S/A) ALEV YAYMAYAN 16 Lİ	1	10	649,04
001 027 110024 00 00	W OTOMAT KUTUSU (S/Ü) ALEV YAYMAYAN 24 LÜ	1	5	902,59
001 027 010024 00 00	W OTOMAT KUTUSU (S/A) ALEV YAYMAYAN 24 LÜ	1	5	892,02
001 027 110036 00 00	W OTOMAT KUTUSU (S/Ü) ALEV YAYMAYAN 36 Lİ	1	5	1.270,30
001 027 010036 00 00	W OTOMAT KUTUSU (S/A) ALEV YAYMAYAN 36 Lİ	1	5	1.286,33



## SPİRALLİ KABLolar

Tüm spirallerin HALOJEN FREE özelliği mevcuttur.

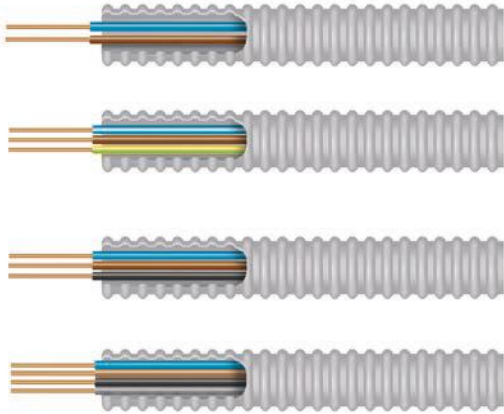

### SPİRALLİ ENERJİ KABLolar HALOJEN FREE



Ürün Kodu	Kablo Kesit (mm <sup>2</sup> )	Spiral Özellik	Spiral Çap (Ø mm)
<b>H07Z1-U (NYA) KABLolar HALOJEN FREE</b>			
122 051 215014	2 x 1,5	HF-PE	16
122 051 315014	3 x 1,5	HF-PE	16
122 051 415016	4 x 1,5	HF-PE	16
122 051 515020	5 x 1,5	HF-PE	20
122 051 225014	2 x 2,5	HF-PE	16
122 051 325016	3 x 2,5	HF-PE	16
122 051 425020	4 x 2,5	HF-PE	16
122 051 525025	5 x 2,5	HF-PE	25

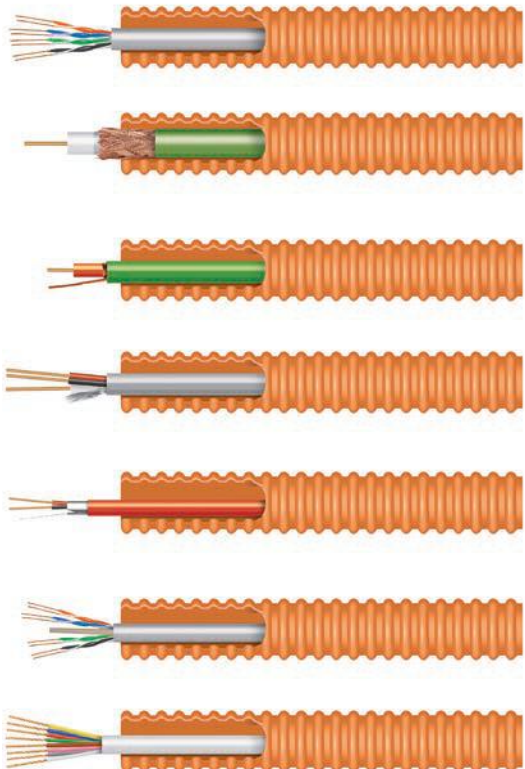

### SPİRALLİ ZAYIF AKIM KABLolar HALOJEN FREE



Ürün Kodu	Kablo Kesit (mm <sup>2</sup> )	Spiral Özellik	Spiral Çap (Ø mm)
<b>(LSZH) DATA KABLolar HALOJEN FREE</b>			
122 053 100516	U/UTP CAT5e (4x2x24AWG)	HF-PE	16
122 053 100616	U/UTP CAT6 (4x2x23AWG)	HF-PE	16
<b>(PHY - HF) KOAKSİYEL KABLolar HALOJEN FREE</b>			
122 053 200416	RG 6 U/4 (Cu/AL)	HF-PE	16
122 053 200616	RG 6 U/6 (Cu/Cu)	HF-PE	16
<b>CCTV KAMERA KABLolar HALOJEN FREE</b>			
122 053 301214	1+2 RG 59 Mini (2x0,50 mm <sup>2</sup> )	HF-PE	16
122 053 301416	1+4 RG 59 Mini (2x0,50 mm <sup>2</sup> ) + (2x0,22 mm <sup>2</sup> )	HF-PE	16
<b>J-H (st) H YANGIN İHBAR KABLolar HALOJEN FREE</b>			
122 053 401214	1x2x0,80 mm <sup>2</sup> + 0,80 mm <sup>2</sup>	HF-PE	16
122 053 402216	2x2x0,80 mm <sup>2</sup> + 0,80 mm <sup>2</sup>	HF-PE	16
<b>LIHH DİYAFON KABLolar HALOJEN FREE</b>			
122 053 502216	LIHH 8x0,22 mm <sup>2</sup>	HF-PE	16

\* Güncel fiyatlar için satış temsilciniz ile irtibata geçiniz.

## SPİRALLİ KABLolar

Tüm spirallerin HALOJEN FREE özelliği mevcuttur.

### SPİRALLİ ENERJİ KABLolar

Ürün Kodu	Kablo Kesit (mm <sup>2</sup> )	Spiral Özellik	Spiral Çap (Ø mm)
<b>H07Z1-U (NYA) KABLolar</b>			
122 050 215014	2 x 1,5	HF-PE	16
122 050 315014	3 x 1,5	HF-PE	16
122 050 415016	4 x 1,5	HF-PE	16
122 050 515020	5 x 1,5	HF-PE	20
122 050 225014	2 x 2,5	HF-PE	16
122 050 325016	3 x 2,5	HF-PE	16
122 050 425020	4 x 2,5	HF-PE	16
122 050 525025	5 x 2,5	HF-PE	25

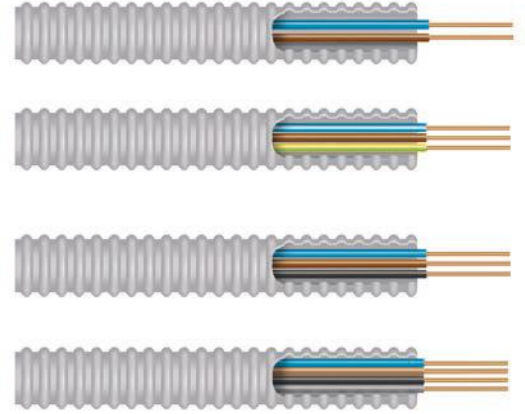





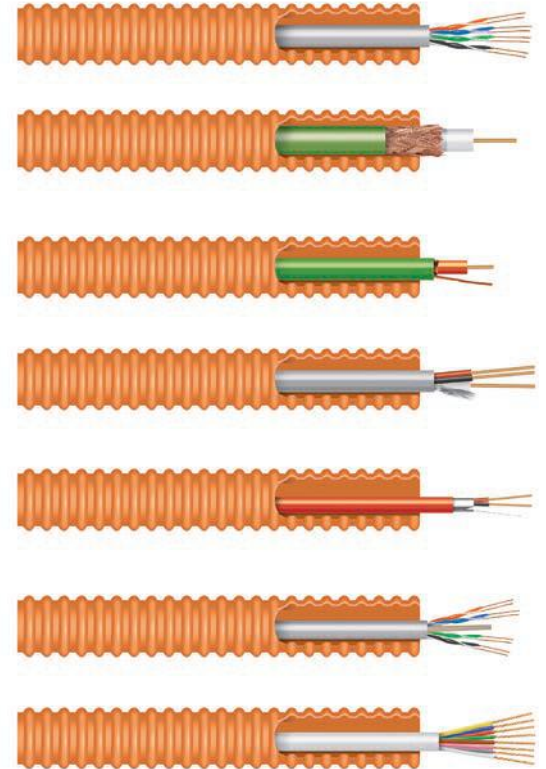



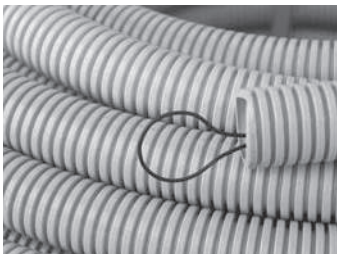
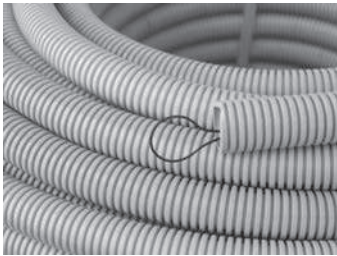

### SPİRALLİ ZAYIF AKIM KABLolar

Ürün Kodu	Kablo Kesit (mm <sup>2</sup> )	Spiral Özellik	Spiral Çap (Ø mm)
<b>DATA KABLolar</b>			
122 052 100516	U/UTP CAT5e	HF-PE	16
122 052 100616	U/UTP CAT6e	HF-PE	16
<b>KOAKSİYEL KABLolar</b>			
122 052 200416	RG 59 U/2 (Cu/AL)	HF-PE	16
122 052 200616	RG 6 U/4 (Cu/AL)	HF-PE	16
122 052 200616	RG 6 U/6 (Cu/Cu)	HF-PE	16
<b>CCTV KAMERA KABLolar</b>			
122 052 301214	CCTV 1+2 (2x0,22 mm <sup>2</sup> )	HF-PE	16
122 052 301416	CCTV 1+4 (2x2x0,22 mm <sup>2</sup> )	HF-PE	16
<b>J-H (st) H YANGIN İHBAR KABLolar</b>			
122 052 401215	JY(st)Y 1x2x0,80 mm <sup>2</sup> + 0,40 mm <sup>2</sup>	HF-PE	16
122 052 402216	JY(st)Y 2x2x0,80 mm <sup>2</sup> + 0,40 mm <sup>2</sup>	HF-PE	16
<b>LIHH DİYAFON KABLolar</b>			
122 052 502216	DT-8 8x0,22 mm <sup>2</sup>	HF-PE	16



\* Güncel fiyatlar için satış temsilciniz ile iletişime geçiniz.



Ürün Kodu	Ürün Adı	Ort. İç Çap	Ort. Dış Çap	Kutu Mt.	Koli Adet	Fiyat (₺)
<b>HAFİF SERİ PVC SİRALER - ALEV YAYMAYAN (320N)</b>						
						
001 020 010016 00 17	16 Ø A.YAYMAYAN SİRAL (HAFİF SERİ)	11,4	15,85	100 mt.	500	8,17
001 020 010020 00 17	20 Ø A.YAYMAYAN SİRAL (HAFİF SERİ)	14,5	19,85	100 mt.	500	12,71
001 020 010025 00 17	25 Ø A.YAYMAYAN SİRAL (HAFİF SERİ)	18,7	24,8	50 mt.	250	17,25
001 020 010032 00 17	32 Ø A.YAYMAYAN SİRAL (HAFİF SERİ)	24,9	31,8	50 mt.	250	22,93
<b>AĞIR SERİ PVC SİRALER -ALEV YAYMAYAN (750N)</b>						
						
001 020 000016 00 17	16 Ø A.YAYMAYAN SİRAL (AĞIR SERİ)	11,2	15,85	100 mt.	500	9,08
001 020 000020 00 17	20 Ø A.YAYMAYAN SİRAL (AĞIR SERİ)	14,4	19,85	100 mt.	500	13,62
001 020 000025 00 17	25 Ø A.YAYMAYAN SİRAL (AĞIR SERİ)	18,1	24,8	50 mt.	250	18,17
001 020 000032 00 17	32 Ø A.YAYMAYAN SİRAL (AĞIR SERİ)	24,7	31,8	50 mt.	250	23,83
<b>HAFİF SERİ PVC TELLİ SİRALER - ALEV YAYMAYAN (320N)</b>						
						
001 020 120016 00 17	16 Ø TELLİ A.YAYMAYAN (HAFİF SERİ)	11,4	15,85	100 mt.	500	10,22
001 020 120020 00 17	20 Ø TELLİ A.YAYMAYAN (HAFİF SERİ)	14,5	19,85	100 mt.	500	13,85
001 020 120025 00 17	25 Ø TELLİ A.YAYMAYAN (HAFİF SERİ)	18,7	24,8	50 mt.	250	18,39
001 020 120032 00 17	32 Ø TELLİ A.YAYMAYAN (HAFİF SERİ)	24,9	31,8	50 mt.	250	24,07
<b>AĞIR SERİ PVC TELLİ SİRALER - ALEV YAYMAYAN (750N)</b>						
						
001 020 100016 00 17	16 Ø TELLİ A.YAYMAYAN (AĞIR SERİ)	11,2	15,85	100 mt.	500	10,68
001 020 100020 00 17	20 Ø TELLİ A.YAYMAYAN (AĞIR SERİ)	14,4	19,85	100 mt.	500	15,43
001 020 100025 00 17	25 Ø TELLİ A.YAYMAYAN (AĞIR SERİ)	18,1	24,8	50 mt.	250	20,18
001 020 100032 00 17	32 Ø TELLİ A.YAYMAYAN (AĞIR SERİ)	24,7	31,8	50 mt.	250	26,10
<b>HALOJEN FREE SİRALER -ALEV YAYAN (320N)</b>						
						
001 020 140016 00 17	16 Ø HALOJEN FREE SPR. (ALEV YAYAN)	11,2	15,7	100 mt.	500	6,08
001 020 140020 00 17	20 Ø HALOJEN FREE SPR. (ALEV YAYAN)	14,4	19,85	100 mt.	500	7,46
001 020 140025 00 17	25 Ø HALOJEN FREE SPR. (ALEV YAYAN)	19,1	24,7	50 mt.	250	10,19
001 020 140032 00 17	32 Ø HALOJEN FREE SPR. (ALEV YAYAN)	24,85	31,6	50 mt.	250	12,71
001 020 140040 00 17	40 Ø HALOJEN FREE SPR. (ALEV YAYAN)			25 mt.	125	20,93
001 020 140050 00 17	50 Ø HALOJEN FREE SPR. (ALEV YAYAN)			25 mt.	125	28,04
<b>HALOJEN FREE SİRALER -ALEV YAYAN (750N)</b>						
						
001 020 740020 00 17	20 Ø HALOJEN FREE SPR. (ALEV YAYAN)	14,4	19,85	100 mt.	500	21,83
001 020 740025 00 17	25 Ø HALOJEN FREE SPR. (ALEV YAYAN)	18,7	24,7	50 mt.	250	30,72
001 020 740032 00 17	32 Ø HALOJEN FREE SPR. (ALEV YAYAN)	24,2	31,6	50 mt.	250	39,61
<b>HALOJEN FREE SİRALER TELLİ - ALEV YAYAN (320N)</b>						
						
001 020 141016 00 17	16 Ø H.FREE SİRAL(A.YAYAN)(TELLİ)	11,2	15,7	100 mt.	500	7,64
001 020 141020 00 17	20 Ø H.FREE SİRAL(A.YAYAN)(TELLİ)	14,4	19,85	100 mt.	500	8,75
001 020 141025 00 17	25 Ø H.FREE SİRAL(A.YAYAN)(TELLİ)	19,1	24,7	50 mt.	250	11,29
001 020 141032 00 17	32 Ø H.FREE SİRAL(A.YAYAN)(TELLİ)	24,85	31,6	50 mt.	250	13,84
001 020 141040 00 17	40 Ø H.FREE SİRAL(A.YAYAN)(TELLİ)			25 mt.	125	21,91
<b>HALOJEN FREE SİRALER - ALEV YAYMAYAN (320N)</b>						
						
001 020 150016 00 17	16 Ø HALOJEN FREE SPR.(A.YAYMAYAN)	11,2	15,7	100 mt.	500	9,01
001 020 150020 00 17	20 Ø HALOJEN FREE SPR.(A.YAYMAYAN)	14,4	19,85	100 mt.	500	11,61
001 020 150025 00 17	25 Ø HALOJEN FREE SPR.(A.YAYMAYAN)	19,1	24,7	50 mt.	250	16,47
001 020 150032 00 17	32 Ø HALOJEN FREE SPR.(A.YAYMAYAN)	24,85	31,6	50 mt.	250	19,75
001 020 150040 00 17	40 Ø HALOJEN FREE SPR.(A.YAYMAYAN)			25 mt.	125	33,42
001 020 150050 00 17	50 Ø HALOJEN FREE SPR.(A.YAYMAYAN)			25 mt.	125	44,02
<b>HALOJEN FREE SİRALER - ALEV YAYMAYAN (750N)</b>						
						
001 020 750020 00 17	20 Ø HALOJEN FREE SPR. (ALEV YAYMAYAN)	14,4	19,85	100 mt.	500	22,34
001 020 750025 00 17	25 Ø HALOJEN FREE SPR. (ALEV YAYMAYAN)	18,7	24,7	50 mt.	250	31,44
001 020 750032 00 17	32 Ø HALOJEN FREE SPR. (ALEV YAYMAYAN)	24,2	31,6	50 mt.	250	40,55
<b>HALOJEN FREE SİRALER TELLİ - ALEV YAYMAYAN (320N)</b>						
						
001 020 151016 00 17	16 Ø H.FREE SPR.(A.YAYMAYAN)(TELLİ)	11,2	15,7	100 mt.	500	10,89
001 020 151020 00 17	20 Ø H.FREE SPR.(A.YAYMAYAN)(TELLİ)	14,4	19,85	100 mt.	500	13,87
001 020 151025 00 17	25 Ø H.FREE SPR.(A.YAYMAYAN)(TELLİ)	19,1	24,7	50 mt.	250	18,65
001 020 151032 00 17	32 Ø H.FREE SPR.(A.YAYMAYAN)(TELLİ)	24,85	31,6	50 mt.	250	21,95
001 020 151040 00 17	40 Ø H.FREE SPR.(A.YAYMAYAN)(TELLİ)			25 mt.	125	34,86

Ürün Kodu	Ürün Adı	Ort. İç Çap	Ort. Dış Çap	Kutu Mt./Ad.	Koli Adet	Fiyat (₺)
<b>MEKS SERİSİ PLASTİK SİRALLER - SİYAH</b>						
001 020 400012 00 11	12 Ø PLASTİK SİRALLER (SİYAH)	12,3	15,9	100 mt.	1000	4,89
001 020 400014 00 11	14 Ø PLASTİK SİRALLER (SİYAH)	15,25	18,75	100 mt.	1000	5,49
001 020 400016 00 11	16 Ø PLASTİK SİRALLER (SİYAH)	15,7	19	100 mt.	1000	5,49
001 020 400018 00 11	18 Ø PLASTİK SİRALLER (SİYAH)	19,6	24,03	50 mt.	500	9,00
001 020 400020 00 11	20 Ø PLASTİK SİRALLER (SİYAH)	19,6	24,03	50 mt.	500	9,00
001 020 400026 00 11	26 Ø PLASTİK SİRALLER (SİYAH)	26,15	30,75	50 mt.	250	12,05
001 020 400032 00 11	32 Ø PLASTİK SİRALLER (SİYAH)	29,1	34,3	50 mt.	250	13,24
001 020 400040 00 11	40 Ø PLASTİK SİRALLER (SİYAH)	36,2	42,2	25 mt.	125	21,48
001 020 400050 00 11	50 Ø PLASTİK SİRALLER (SİYAH)	48,5	54,5	25 mt.	125	26,80

### MEKS SERİSİ PLASTİK SİRALLER - SİYAH - TELLİ

001 020 410014 00 11	14 Ø PLASTİK SİRALLER (SİYAH) TELLİ	15,25	18,75	100 mt.	1000	6,48
001 020 410016 00 11	16 Ø PLASTİK SİRALLER (SİYAH) TELLİ	15,7	19	100 mt.	1000	6,48
001 020 410018 00 11	18 Ø PLASTİK SİRALLER (SİYAH) TELLİ	19,6	24,03	50 mt.	500	9,99
001 020 410020 00 11	20 Ø PLASTİK SİRALLER (SİYAH) TELLİ	19,6	24,03	50 mt.	500	9,99
001 020 410026 00 11	26 Ø PLASTİK SİRALLER (SİYAH) TELLİ	26,15	30,75	50 mt.	250	13,05
001 020 410032 00 11	32 Ø PLASTİK SİRALLER (SİYAH) TELLİ	29,1	34,3	50 mt.	250	14,23
001 020 410040 00 11	40 Ø PLASTİK SİRALLER (SİYAH) TELLİ	36,2	42,2	25 mt.	125	22,48

### PLASTİK SİRALLER - RENKLİ

001 020 400014 00 XX	14 Ø PLS. SİRAL (GRİ-BYZ-KIR-MAVİ)	15,25	18,75	100 mt.	1000	6,11
001 020 400016 00 XX	16 Ø PLS. SİRAL (GRİ-BYZ-KIR-MAVİ)	15,7	19	100 mt.	1000	6,11
001 020 400018 00 XX	18 Ø PLS. SİRAL (GRİ-BYZ-KIR-MAVİ)	19,6	24,03	50 mt.	500	9,99
001 020 400020 00 XX	20 Ø PLS. SİRAL (GRİ-BYZ-KIR-MAVİ)	19,6	24,03	50 mt.	500	9,99
001 020 400026 00 XX	26 Ø PLS. SİRAL (GRİ-BYZ-KIR-MAVİ)	26,15	30,75	50 mt.	250	13,40
001 020 400032 00 XX	32 Ø PLS. SİRAL (GRİ-BYZ-KIR-MAVİ)	29,1	34,3	50 mt.	250	14,79
001 020 400040 00 XX	40 Ø PLS. SİRAL (GRİ-BYZ-KIR-MAVİ)	36,2	42,2	25 mt.	125	23,86
001 020 400050 00 XX	50 Ø PLS. SİRAL (GRİ-BYZ-KIR-MAVİ)	48,5	54,5	25 mt.	125	29,61
001 020 990016 00 17	16 mm SİRAL EK MUFU (GRİ)			200 ad.		7,15
001 020 990020 00 17	20 mm SİRAL EK MUFU (GRİ)			200 ad.		8,22
001 020 990025 00 17	25 mm SİRAL EK MUFU (GRİ)			100 ad.		10,61
001 020 990032 00 17	32 mm SİRAL EK MUFU (GRİ)			200 ad.		14,23

### KORUGE BORULAR (250N)

096 045 150050	50 Ø KORUGE KANGAL BORU	43	50	100 mt.		40,66
096 045 150060	63 Ø KORUGE KANGAL BORU	54	63	100 mt.		51,96
096 045 150075	75 Ø KORUGE KANGAL BORU	64	75	100 mt.		63,25
096 045 150100	100 Ø KORUGE BOY BORU (6 MT.)	87	100	6 mt.		77,93
096 045 150115	115 Ø KORUGE BOY BORU (6 MT.)	100	115	6 mt.		86,59
096 045 150004	50 Ø MANŞON			1 ad.		12,10
096 045 150003	75 Ø MANŞON			1 ad.		15,82
096 045 150002	100 Ø MANŞON			1 ad.		19,81
096 045 150001	115 Ø MANŞON			1 ad.		24,19

### LOGAR KUTUSU

074 048 622020	20X20 LOGAR KUTUSU TAKIM			1 ad.		189,75
074 048 623030	30X30 LOGAR KUTUSU TAKIM			1 ad.		391,88
074 048 624040	40X40 LOGAR KUTUSU TAKIM			1 ad.		935,71
074 048 625555	55X55 LOGAR KUTUSU TAKIM			1 ad.		1.938,75







Ürün Kodu	Ürün Adı	Ort. İç Çap	Ort. Dış Çap	Kutu Mt.	Koli Adet	Fiyat (₺)
<b>EKO SERİSİ ÇELİK SİRALLER</b>						
001 054 150009 00 66	9 Ø EKO ÇELİK SİRALLER	9	12,1	50 mt.	200	16,30
001 054 150011 00 66	11 Ø EKO ÇELİK SİRALLER (3/8")	11	14,1	50 mt.	200	16,93
001 054 150014 00 66	14 Ø EKO ÇELİK SİRALLER (1/2")	14	17,1	50 mt.	200	20,57
001 054 150016 00 66	16 Ø EKO ÇELİK SİRALLER	16	19,1	50 mt.	200	22,67
001 054 150018 00 66	18 Ø EKO ÇELİK SİRALLER	18	21,1	50 mt.	200	25,88
001 054 150021 00 66	21 Ø EKO ÇELİK SİRALLER (3/4")	21	24,1	50 mt.	200	28,93
001 054 150026 00 66	26 Ø EKO ÇELİK SİRALLER (1")	26	29,1	25 mt.	100	39,65
001 054 150029 00 66	29 Ø EKO ÇELİK SİRALLER (1 1/4")	29	32,1	25 mt.	100	42,82
001 054 150032 00 66	32 Ø EKO ÇELİK SİRALLER	32	35,1	25 mt.	100	45,96
001 054 150037 00 66	37 Ø EKO ÇELİK SİRALLER (1 1/2")	37	41,1	25 mt.	100	60,49
001 054 150042 00 66	42 Ø EKO ÇELİK SİRALLER	42	45,1	25 mt.	100	70,45
001 054 150050 00 66	50 Ø EKO ÇELİK SİRALLER (2")	50	53,1	25 mt.	100	97,77

<b>EKO SERİSİ ÇELİK SİRALLER - KILAVUZ TELLİ</b>						
001 054 221011 00 66	11 Ø EKO Ç. SİRAL(TELLI)(3/8")	11	14,1	50 mt.	200	19,33
001 054 221014 00 66	14 Ø EKO Ç. SİRAL(TELLI)(1/2")	14	17,1	50 mt.	200	23,68
001 054 221016 00 66	16 Ø EKO Ç. SİRAL (TELLİ)	16	19,1	50 mt.	200	25,23
001 054 221018 00 66	18 Ø EKO Ç. SİRAL(TELLI)	18	21,1	50 mt.	200	30,49
001 054 221021 00 66	21 Ø EKO Ç. SİRAL(TELLI) (3/4")	21	24,1	50 mt.	200	31,81
001 054 221026 00 66	26 Ø EKO Ç. SİRAL(TELLI)(1")	26	29,1	25 mt.	100	43,17
001 054 221029 00 66	29 Ø EKO Ç. SİRAL(TELLI)(1 1/4")	29	32,1	25 mt.	100	45,68
001 054 221032 00 66	32 Ø EKO Ç. SİRAL(TELLI)	32	35,1	25 mt.	100	51,97
001 054 221037 00 66	37 Ø EKO Ç. SİRAL(TELLI)(1 1/2")	37	41,1	25 mt.	100	63,85
001 054 221042 00 66	42 Ø EKO Ç. SİRAL(TELLI)	42	45,1	25 mt.	100	73,75
001 054 221050 00 66	50 Ø EKO Ç. SİRAL(TELLI) (2")	50	53,1	25 mt.	100	101,53

<b>EKO SERİSİ İZOLELİ ÇELİK SİRALLER</b>						
001 054 160009 00 11	9 Ø EKO İZOLELİ Ç. SİRAL	9	13,2	50 mt.		20,64
001 054 160011 00 11	11 Ø EKO İZOLELİ Ç. SİRAL(3/8")	11	15,2	50 mt.		22,49
001 054 160014 00 11	14 Ø EKO İZOLELİ Ç. SİRAL(1/2")	14	18,4	50 mt.		27,05
001 054 160016 00 11	16 Ø EKO İZOLELİ Ç. SİRAL	16	20,4	50 mt.		30,14
001 054 160018 00 11	18 Ø EKO İZOLELİ Ç. SİRAL	18	22,4	50 mt.		34,73
001 054 160021 00 11	21 Ø EKO İZOLELİ Ç. SİRAL (3/4")	21	25,4	50 mt.		41,14
001 054 160026 00 11	26 Ø EKO İZOLELİ Ç. SİRAL(1")	26	30,4	25 mt.		50,88
001 054 160029 00 11	29 Ø EKO İZOLELİ Ç. SİRAL(1 1/4")	29	33,4	25 mt.		55,39
001 054 160032 00 11	32 Ø EKO İZOLELİ Ç. SİRAL	32	36,4	25 mt.		61,76
001 054 160037 00 11	37 Ø EKO İZOLELİ Ç. SİRAL (1 1/2")	37	42,4	25 mt.		79,11
001 054 160042 00 11	42 Ø EKO İZOLELİ Ç. SİRAL	42	46,4	25 mt.		96,26
001 054 160050 00 11	50 Ø EKO İZOLELİ Ç. SİRAL(2")	50	54,4	25 mt.		129,02

<b>EKO SERİSİ İZOLELİ ÇELİK SİRALLER - KILAVUZ TELLİ</b>						
001 054 231011 00 11	11 Ø EKO İZO.Ç. SPR.(TELLİ)(3/8")	11	15,2	50 mt.		24,90
001 054 231014 00 11	14 Ø EKO İZO.Ç. SPR.(TELLİ)(1/2")	14	18,4	50 mt.		30,45
001 054 231016 00 11	16 Ø EKO İZO.Ç. SPR. (TELLİ)	16	20,4	50 mt.		32,70
001 054 231018 00 11	18 Ø EKO İZO.Ç. SPR.(TELLİ)	18	22,4	50 mt.		36,88
001 054 231021 00 11	21 Ø EKO İZO.Ç. SPR.(TELLİ) (3/4")	21	25,4	50 mt.		43,57
001 054 231026 00 11	26 Ø EKO İZO.Ç. SPR.(TELLİ)(1")	26	30,4	25 mt.		53,68
001 054 231029 00 11	29 Ø EKO İZO.Ç. SPR.(TELLİ)(1 1/4")	29	33,4	25 mt.		57,56
001 054 231032 00 11	32 Ø EKO İZO.Ç. SPR.(TELLİ)	32	36,4	25 mt.		67,83
001 054 231037 00 11	37 Ø EKO İZO.Ç. SPR.(TELLİ)(1 1/2")	37	42,4	25 mt.		83,49
001 054 231042 00 11	42 Ø EKO İZO.Ç. SPR.(TELLİ)	42	46,4	25 mt.		100,60
001 054 231050 00 11	50 Ø EKO İZO.Ç. SPR.(TELLİ) (2")	50	54,4	25 mt.		135,07

<b>MEKS SERİSİ ÇELİK SİRALLER</b>						
001 054 120009 00 66	9 Ø ÇELİK SİRALLER	9	12,1	50 mt.	200	17,47
001 054 120011 00 66	11 Ø ÇELİK SİRALLER(3/8")	11	14,1	50 mt.	200	18,46
001 054 120014 00 66	14 Ø ÇELİK SİRALLER(1/2")	14	17,1	50 mt.	200	22,43
001 054 120016 00 66	16 Ø ÇELİK SİRALLER	16	19,1	50 mt.	200	24,71
001 054 120018 00 66	18 Ø ÇELİK SİRALLER	18	21,1	50 mt.	200	28,22
001 054 120021 00 66	21 Ø ÇELİK SİRALLER (3/4")	21	24,1	50 mt.	200	32,97
001 054 120026 00 66	26 Ø ÇELİK SİRALLER(1")	26	29,1	25 mt.	100	43,25
001 054 120029 00 66	29 Ø ÇELİK SİRALLER(1 1/4")	29	32,1	25 mt.	100	46,36
001 054 120032 00 66	32 Ø ÇELİK SİRALLER	32	35,1	25 mt.	100	51,85
001 054 120037 00 66	37 Ø ÇELİK SİRALLER (1 1/2")	37	41,1	25 mt.	100	65,14
001 054 120042 00 66	42 Ø ÇELİK SİRALLER	42	45,1	25 mt.	100	79,04
001 054 120050 00 66	50 Ø ÇELİK SİRALLER(2")	50	53,1	25 mt.	100	109,64
001 054 120063 00 66	63 Ø ÇELİK SİRALLER	63	66,1	15 mt.	60	148,29

<b>MEKS SERİSİ ÇELİK SİRALLER (KILAVUZ TELLİ)</b>						
001 054 121011 00 66	11 Ø Ç. SİRAL(TELLI)(3/8")	11	14,1	50 mt.	200	21,08
001 054 121014 00 66	14 Ø Ç. SİRAL(TELLI)(1/2")	14	17,1	50 mt.	200	25,83
001 054 121016 00 66	16 Ø Ç. SİRAL (TELLİ)	16	19,1	50 mt.	200	27,51
001 054 121018 00 66	18 Ø Ç. SİRAL(TELLI)	18	21,1	50 mt.	200	33,25
001 054 121021 00 66	21 Ø Ç. SİRAL(TELLI) (3/4")	21	24,1	50 mt.	200	34,88
001 054 121026 00 66	26 Ø Ç. SİRAL(TELLI)(1")	26	29,1	25 mt.	100	46,30
001 054 121029 00 66	29 Ø Ç. SİRAL(TELLI)(1 1/4")	29	32,1	25 mt.	100	49,12
001 054 121032 00 66	32 Ø Ç. SİRAL(TELLI)	32	35,1	25 mt.	100	58,58
001 054 121037 00 66	37 Ø Ç. SİRAL(TELLI)(1 1/2")	37	41,1	25 mt.	100	68,70
001 054 121042 00 66	42 Ø Ç. SİRAL(TELLI)	42	45,1	25 mt.	100	84,35
001 054 121050 00 66	50 Ø Ç. SİRAL(TELLI) (2")	50	53,1	25 mt.	100	115,74
001 054 121063 00 66	63 Ø Ç. SİRAL(TELLI) (2")	63	66,1	15 mt.	60	157,66

Ürün Kodu	Ürün Adı	Ort. İç Çap	Ort. Dış Çap	Kutu Mt./Ad.	Koli Adet	Fiyat (₺)
<b>MEKS SERİSİ İZOLELİ ÇELİK SİRALER</b>						
001 054 130009 00 11	9 Ø İZOLELİ Ç. SİRAL	9	13,2	50 mt.		21,58
001 054 130011 00 11	11 Ø İZOLELİ Ç. SİRAL(3/8")	11	15,2	50 mt.		24,53
001 054 130014 00 11	14 Ø İZOLELİ Ç. SİRAL(1/2")	14	18,4	50 mt.		29,52
001 054 130016 00 11	16 Ø İZOLELİ Ç. SİRAL	16	20,4	50 mt.		32,86
001 054 130018 00 11	18 Ø İZOLELİ Ç. SİRAL	18	22,4	50 mt.		37,88
001 054 130026 00 11	26 Ø İZOLELİ Ç. SİRAL(1")	26	30,4	25 mt.		55,28
001 054 130029 00 11	29 Ø İZOLELİ Ç. SİRAL(1 1/4")	29	33,4	25 mt.		62,29
001 054 130032 00 11	32 Ø İZOLELİ Ç. SİRAL	32	36,4	25 mt.		72,39
001 054 130037 00 11	37 Ø İZOLELİ Ç. SİRAL (1 1/2")	37	42,4	25 mt.		85,87
001 054 130042 00 11	42 Ø İZOLELİ Ç. SİRAL	42	46,4	25 mt.		107,94
001 054 130050 00 11	50 Ø İZOLELİ Ç. SİRAL(2")	50	54,4	25 mt.		144,63
001 054 130063 00 11	63 Ø İZOLELİ ÇELİK SİRAL	63	67,2	15 mt.		185,13



### MEKS SERİSİ İZOLELİ ÇELİK SİRALER - KILAVUZ TELLİ

001 054 140011 00 11	11 Ø İZO.Ç. SPR.(TELLİ)(3/8")	11	15,2	50 mt.		27,16
001 054 140014 00 11	14 Ø İZO.Ç. SPR.(TELLİ)(1/2")	14	18,4	50 mt.		33,21
001 054 140016 00 11	16 Ø İZO.Ç. SPR. (TELLİ)	16	20,4	50 mt.		35,22
001 054 140018 00 11	18 Ø İZO.Ç. SPR.(TELLİ)	18	22,4	50 mt.		39,69
001 054 140026 00 11	26 Ø İZO.Ç. SPR.(TELLİ)(1")	26	30,4	25 mt.		58,32
001 054 140029 00 11	29 Ø İZO.Ç. SPR.(TELLİ)(1 1/4")	29	33,4	25 mt.		65,04
001 054 140032 00 11	32 Ø İZO.Ç. SPR.(TELLİ)	32	36,4	25 mt.		76,31
001 054 140037 00 11	37 Ø İZO.Ç. SPR.(TELLİ)(1 1/2")	37	42,4	25 mt.		90,01
001 054 140042 00 11	42 Ø İZO.Ç. SPR.(TELLİ)	42	46,4	25 mt.		114,09
001 054 140050 00 11	50 Ø İZO.Ç. SPR.(TELLİ) (2")	50	54,4	25 mt.		150,79
001 054 140063 00 11	63 Ø İZO.Ç. SPR.(TELLİ)	63	67,2	15 mt.		193,61



### NİKEL KAPLI ÇELİK SİRAL RAKORU

012 097 030009	CLK- 9 ÇELİK SİRAL RAKORU			1 ad.		129,94
012 097 030011	CLK-11 ÇELİK SİRAL RAKORU			1 ad.		151,59
012 097 030014	CLK-13,5 ÇELİK SİRAL RAKORU			1 ad.		181,91
012 097 030016	CLK-16 ÇELİK SİRAL RAKORU			1 ad.		203,57
012 097 030018	CLK-18 ÇELİK SİRAL RAKORU			1 ad.		238,22
012 097 030026	CLK-26 ÇELİK SİRAL RAKORU			1 ad.		294,53



### SÜPER ETANJ METAL RAKORLAR

057 097 100007	PG-7 METAL RAKOR			1 ad.		1,98 €
057 097 100009	PG-9 METAL RAKOR			1 ad.		2,48 €
057 097 100011	PG-11 METAL RAKOR			1 ad.		3,34 €
057 097 100135	PG-13,5 METAL RAKOR			1 ad.		3,55 €
057 097 100016	PG-16 METAL RAKOR			1 ad.		4,41 €
057 097 100021	PG-21 METAL RAKOR			1 ad.		7,51 €
057 097 100029	PG-29 METAL RAKOR			1 ad.		18,93 €
057 097 100036	PG-36 METAL RAKOR			1 ad.		27,64 €
057 097 100042	PG-42 METAL RAKOR			1 ad.		39,06 €
057 097 100048	PG-48 METAL RAKOR			1 ad.		46,9 €





Ürün Kodu	Ürün Adı	Kutu Mt.	Koli Adet	Fiyat (₺)	
<b>PVC ALEV YAYMAYAN BOY BORULAR</b>					
001 045 120014 30 17	14 Ø PVC ALEV YAYMAYAN BOY BORU (BOY: 3 MT)	☐ ☐	102 mt.	13,48	
001 045 120016 30 17	16 Ø PVC ALEV YAYMAYAN BOY BORU (BOY: 3 MT)	☐ ☐ ☐	102 mt.	16,09	
001 045 120018 30 17	18 Ø PVC ALEV YAYMAYAN BOY BORU (BOY: 3 MT)	☐ ☐	102 mt.	17,85	
001 045 120020 30 17	20 Ø PVC ALEV YAYMAYAN BOY BORU (BOY: 3 MT)	☐ ☐ ☐	102 mt.	23,40	
001 045 120025 30 17	25 Ø PVC ALEV YAYMAYAN BOY BORU (BOY: 3 MT)	☐ ☐ ☐	51 mt.	31,86	
001 045 120032 30 17	32 Ø PVC ALEV YAYMAYAN BOY BORU (BOY: 3 MT)	☐ ☐ ☐	30 mt.	51,75	
001 045 120040 30 17	40 Ø PVC ALEV YAYMAYAN BOY BORU (BOY: 3 MT)	☐ ☐ ☐	30 mt.	99,68	
<b>PVC ALEV YAYMAYAN KENDİNDEN MUFLU BOY BORULAR</b>					
001 045 110014 30 17	14 Ø PVC ALEV YAYMAYAN KENDİNDEN MUFLU BOY BORU (3M)	☐ ☐	102 mt.	16,12	
001 045 110016 30 17	16 Ø PVC ALEV YAYMAYAN KENDİNDEN MUFLU BOY BORU (3M)	☐ ☐ ☐	102 mt.	19,36	
001 045 110018 30 17	18 Ø PVC ALEV YAYMAYAN KENDİNDEN MUFLU BOY BORU (3M)	☐ ☐	102 mt.	21,39	
001 045 110020 30 17	20 Ø PVC ALEV YAYMAYAN KENDİNDEN MUFLU BOY BORU (3M)	☐ ☐ ☐	102 mt.	27,75	
001 045 110025 30 17	25 Ø PVC ALEV YAYMAYAN KENDİNDEN MUFLU BOY BORU (3M)	☐ ☐ ☐	51 mt.	38,33	
001 045 110032 30 17	32 Ø PVC ALEV YAYMAYAN KENDİNDEN MUFLU BOY BORU (3M)	☐ ☐ ☐	30 mt.	62,20	
001 045 110040 30 17	40 Ø PVC ALEV YAYMAYAN KENDİNDEN MUFLU BOY BORU (3M)	☐ ☐ ☐	30 mt.	119,40	
<b>DİRSEK VE MUFLAR - ALEV YAYMAYAN</b>					
001 051 010014 00 17	14 Ø DİRSEK ALEV YAYMAYAN	☐ ☐	100 ad.	700	8,66
001 051 010016 00 17	16 Ø DİRSEK ALEV YAYMAYAN	☐ ☐ ☐	100 ad.	600	8,91
001 051 010018 00 17	18 Ø DİRSEK ALEV YAYMAYAN	☐ ☐	100 ad.	400	9,15
001 051 010020 00 17	20 Ø DİRSEK ALEV YAYMAYAN	☐ ☐ ☐	100 ad.	300	9,89
001 051 010025 00 17	25 Ø DİRSEK ALEV YAYMAYAN	☐ ☐ ☐	50 ad.	150	19,37
001 051 010032 00 17	32 Ø DİRSEK ALEV YAYMAYAN	☐ ☐ ☐	50 ad.	100	35,75
001 051 030014 00 17	14-16 Ø MUF ALEV YAYMAYAN	☐ ☐ ☐	100 ad.	700	4,62
001 051 030018 00 17	18-20 Ø MUF ALEV YAYMAYAN	☐ ☐ ☐	100 ad.	500	4,87
001 051 030025 00 17	25 Ø MUF ALEV YAYMAYAN	☐ ☐ ☐	50 ad.	300	16,50
001 051 030032 00 17	32 Ø MUF ALEV YAYMAYAN	☐ ☐ ☐	50 ad.	200	18,41
<b>GEÇMELİ TİP ANTİGRON BORU KROŞELERİ</b>					
001 048 010016 00 17	16 Ø ANTİGRON BORU KROŞESİ (GEÇMELİ)		100 ad.	2000	2,30
001 048 010018 00 17	18 Ø ANTİGRON BORU KROŞESİ (GEÇMELİ)		100 ad.	3000	2,97
001 048 010020 00 17	20 Ø ANTİGRON BORU KROŞESİ (GEÇMELİ)		100 ad..	4500	3,09
001 048 010025 00 17	25 Ø ANTİGRON BORU KROŞESİ (GEÇMELİ)		100 ad.	1000	3,28
001 048 010032 00 17	32 Ø ANTİGRON BORU KROŞESİ (GEÇMELİ)		100 ad.	800	3,51
001 048 010040 00 17	40 Ø ANTİGRON BORU KROŞESİ (GEÇMELİ)		50 ad.	750	5,75
074 048 050016	16 Ø ANTİGRON BORU KROŞESİ KAPAKLI(GEÇMELİ)		100 ad.	4000	2,42
074 048 050017	20 Ø ANTİGRON BORU KROŞESİ KAPAKLI(GEÇMELİ)		100 ad.	2500	3,17
074 048 050025	25 Ø ANTİGRON BORU KROŞESİ KAPAKLI(GEÇMELİ)		100 ad.	2500	3,63
074 048 050032	32 Ø ANTİGRON BORU KROŞESİ KAPAKLI(GEÇMELİ)		50 ad.	1500	4,50
<b>FİBER SUSTALAR</b>					
999 999 000779	FİBER KILAVUZ 11MM (100-120-150-200M)		1 mt.		112,95
999 999 000780	FİBER KILAVUZ MAKARASI		1 ad.		4.924,46
<b>PLASTİK SUSTALAR - KILAVUZ TELLİ</b>					
049 019 400010	10 MT. KILAVUZ TELLİ PLASTİK SUSTA		1 ad.	25	112,95
049 019 400015	15 MT. KILAVUZ TELLİ PLASTİK SUSTA		1 ad.	20	169,42
049 019 400020	20 MT. KILAVUZ TELLİ PLASTİK SUSTA		1 ad.	15	225,89
049 019 400025	25 MT. KILAVUZ TELLİ PLASTİK SUSTA		1 ad.	15	282,37
<b>ÇELİK SUSTA ve ZİNCİR</b>					
001 019 000010 00 00	SUSTA (1.KALİTE) (10M)		40 ad.	40	236,44
001 019 000015 00 00	SUSTA (1.KALİTE) (15M)		30 ad.	30	334,36
001 019 000020 00 00	SUSTA (1.KALİTE) (20M)		20 ad.	20	431,08
001 019 000025 00 00	SUSTA (1.KALİTE) (25M)		15 ad.	15	528,38
001 019 100010 00 00	TAKVİYELİ SUSTA(1.KALİTE)(10M)		40 ad.	40	252,06
001 019 100015 00 00	TAKVİYELİ SUSTA(1.KALİTE)(15M)		30 ad.	30	350,41
001 019 100020 00 00	TAKVİYELİ SUSTA(1.KALİTE)(20M)		20 ad.	20	458,41
001 019 100025 00 00	TAKVİYELİ SUSTA(1.KALİTE)(25M)		15 ad.	15	564,55
001 018 000001 00 00	FLORESAN ZİNCİRİ		100 mt.	500	16,72

Ürün Kodu	Ürün Adı	Kutu Mt./Ad.	Koli Adet	Fiyat (₺)
<b>BOY BORULAR - HALOJEN FREE - ALEV YAYMAYAN - FLARET - 320N</b> 				
001 045 500016 30 17	16 Ø HALOJEN FREE A.YAYMAYAN BORU(3M)(320N)	102 mt.		53,56
001 045 500020 30 17	20 Ø HALOJEN FREE A.YAYMAYAN BORU(3M)(320N)	102 mt.		65,56
001 045 500025 30 17	25 Ø HALOJEN FREE A.YAYMAYAN BORU(3M)(320N)	102 mt.		91,23
001 045 500032 30 17	32 Ø HALOJEN FREE A.YAYMAYAN BORU(3M)(320N)	102 mt.		129,44
001 045 500040 30 17	40 Ø HALOJEN FREE A.YAYMAYAN BORU(3M)(320N)	51 mt.		185,16
001 045 500050 30 17	50 Ø HALOJEN FREE A.YAYMAYAN BORU(3M)(320N)	30 mt.		305,22
<b>BOY BORULAR - HALOJEN FREE - ALEV YAYMAYAN - FLARET - 750N</b> 				
001 045 510016 30 17	16 Ø HALOJEN FREE A.YAYMAYAN BORU(3M)(750N)	102 mt.		56,56
001 045 510020 30 17	20 Ø HALOJEN FREE A.YAYMAYAN BORU(3M)(750N)	102 mt.		71,57
001 045 510025 30 17	25 Ø HALOJEN FREE A.YAYMAYAN BORU(3M)(750N)	102 mt.		97,23
001 045 510032 30 17	32 Ø HALOJEN FREE A.YAYMAYAN BORU(3M)(750N)	102 mt.		135,44
001 045 510040 30 17	40 Ø HALOJEN FREE A.YAYMAYAN BORU(3M)(750N)	51 mt.		191,16
001 045 510050 30 17	50 Ø HALOJEN FREE A.YAYMAYAN BORU(3M)(750N)	30 mt.		377,60
<b>BOY BORULAR - HALOJEN FREE - ALEV YAYMAYAN - FLARET - 1250N</b> 				
001 045 520016 30 17	16 Ø HALOJEN FREE A.YAYMAYAN BORU(3M)(1250N)	102 mt.		61,21
001 045 520020 30 17	20 Ø HALOJEN FREE A.YAYMAYAN BORU(3M)(1250N)	102 mt.		76,22
001 045 520025 30 17	25 Ø HALOJEN FREE A.YAYMAYAN BORU(3M)(1250N)	102 mt.		105,43
001 045 520032 30 17	32 Ø HALOJEN FREE A.YAYMAYAN BORU(3M)(1250N)	102 mt.		153,53
001 045 520040 30 17	40 Ø HALOJEN FREE A.YAYMAYAN BORU(3M)(1250N)	51 mt.		197,16
001 045 520050 30 17	50 Ø HALOJEN FREE A.YAYMAYAN BORU(3M)(1250N)	30 mt.		387,95
<b>BORU - SİRAL EK MUF - ALEV YAYMAYAN</b>				
999 999 777616	16 LİK BORU-SİRAL EK MUFU A.YAYMAYAN	100 ad.	4000	14,68
999 999 777620	20 LİK BORU-SİRAL EK MUFU A.YAYMAYAN	100 ad.	2000	15,13
999 999 777625	25 LİK BORU-SİRAL EK MUFU A.YAYMAYAN	100 ad.	2000	21,01
999 999 777632	32 LİK BORU-SİRAL EK MUFU A.YAYMAYAN	100 ad.	1000	26,20
<b>DÜZ BORU T DİRSEK - ALEV YAYMAYAN</b>				
999 999 999888	16 LİK DÜZ BORU T DİRSEK A.YAYMAYAN	100 ad.	1500	31,11
999 999 999889	20 LİK DÜZ BORU T DİRSEK A.YAYMAYAN	100 ad.	1000	31,55
999 999 999890	25 LİK DÜZ BORU T DİRSEK A.YAYMAYAN	50 ad.	800	44,51
999 999 999891	32 LİK DÜZ BORU T DİRSEK A.YAYMAYAN	25 ad.	500	57,91
<b>DÜZ BORU RAKORU - ALEV YAYMAYAN</b>				
999 999 998816	Ø16 DÜZ BORU REKORU A. YAYMAYAN	100 ad.	4000	31,63
999 999 998820	Ø20 DÜZ BORU REKORU A. YAYMAYAN	100 ad.	2500	35,01
999 999 998825	Ø25 DÜZ BORU REKORU A. YAYMAYAN	100 ad.	2000	39,98
999 999 998832	Ø32 DÜZ BORU REKORU A. YAYMAYAN	100 ad.	1000	53,54
<b>ANTİGRON BORU KROŞESİ (GEÇMELİ) - ALEV YAYMAYAN</b>				
074 048 060016	Ø16 ANT. BORU KRO. (GEÇ. TİP) KAPAKLI A.YAYMAYAN	100 ad.	4000	6,33
074 048 060020	Ø20 ANT. BORU KRO. (GEÇ. TİP) KAPAKLI A.YAYMAYAN	100 ad.	3500	7,23
074 048 060025	Ø25 ANT. BORU KRO. (GEÇ. TİP) KAPAKLI A.YAYMAYAN	100 ad.	3000	8,81
074 048 060032	Ø32 ANT. BORU KRO. (GEÇ. TİP) KAPAKLI A.YAYMAYAN	100 ad.	2000	10,84
<b>SİRAL RAKORU - ALEV YAYMAYAN</b>				
999 999 777516	Ø16 KAPAKLI SİRAL REKORU A.YAYMAYAN	100 ad.	4000	30,27
999 999 777520	Ø20 KAPAKLI SİRAL REKORU A.YAYMAYAN	100 ad.	3000	36,59
999 999 777525	Ø25 KAPAKLI SİRAL REKORU A.YAYMAYAN	100 ad.	1800	41,79
999 999 777532	Ø32 KAPAKLI SİRAL REKORU A.YAYMAYAN	100 ad.	1000	53,54





## PVC BORU AKSESUARLARI



Ürün Kodu	Ürün Adı	Kutu/Koli Adedi	Fiyat DOLAR (\$)
999 998 000001	PVC BUAT 20 (1'Lİ)	400	0,72
999 998 000002	PVC BUAT 20 (2'Lİ)	400	0,72
999 998 000003	PVC BUAT 20 (3'LÜ)	400	0,77
999 998 000004	PVC BUAT 20 (4'LÜ)	400	0,77
999 998 000005	PVC BUAT 25 (1'Lİ)	300	0,99
999 998 000006	PVC BUAT 25 (2'Lİ)	300	0,99
999 998 000007	PVC BUAT 25 (3'LÜ)	300	1,04
999 998 000008	PVC BUAT 25 (4'LÜ)	300	1,04



Ürün Kodu	Ürün Adı	Kutu/Koli Adedi	Fiyat DOLAR (\$)
999 998 000009	PVC İNGİLİZ TİP KASA 1'Lİ	200	0,77
999 998 000010	PVC İNGİLİZ TİP KASA 2'Lİ	100	1,45



Ürün Kodu	Ürün Adı	Kutu/Koli Adedi	Fiyat DOLAR (\$)
999 999 777816	Q16 MM ESNEK DÜZ BORU MUF ALEV YAYMAYAN	400	2,80
999 999 777820	Q20 MM ESNEK DÜZ BORU MUF ALEV YAYMAYAN	400	3,25
999 999 777825	Q25 MM ESNEK DÜZ BORU MUF ALEV YAYMAYAN	400	4,74
999 999 777832	Q32 MM ESNEK DÜZ BORU MUF ALEV YAYMAYAN	400	7,54



Ürün Kodu	Ürün Adı	Kutu/Koli Adedi	Fiyat EURO (€)
999 999 777094	Q16 BORU BÜKME YAYI	1	35,01
999 999 777093	Q20 BORU BÜKME YAYI	1	45,18
999 999 777099	Q25 BORU BÜKME YAYI	1	56,47
999 999 777095	Q32 BORU BÜKME YAYI	1	65,51
999 999 777096	Q40 BORU BÜKME YAYI	1	103,91
999 999 777097	Q50 BORU BÜKME YAYI	1	135,54



Ürün Kodu	Ürün Adı	Kutu Mt./Ad.	Fiyat (₺)
-----------	----------	--------------	-----------

### YENİ MUTLUSAN EKO SERİSİ TURUNCU BORULAR - HALOJEN FREE - ALEV YAYAN - 320N - 6 ATÜ

001 165 710014 00 12	Ø14/6 ATÜ BORU (H.FREE TURUNCU) (A.YAYAN) (EKO)	100 mt.	8,71
001 165 710016 00 12	Ø16/6 ATÜ BORU (H.FREE TURUNCU) (A.YAYAN) (EKO)	100 mt.	10,06
001 165 710018 00 12	Ø18/6 ATÜ BORU (H.FREE TURUNCU) (A.YAYAN) (EKO)	100 mt.	12,53
001 165 710020 00 12	Ø20/6 ATÜ BORU (H.FREE TURUNCU) (A.YAYAN) (EKO)	100 mt.	13,41
001 165 710025 00 12	Ø25/6 ATÜ BORU (H.FREE TURUNCU) (A.YAYAN) (EKO)	100 mt.	20,11
001 165 710032 00 12	Ø32/6 ATÜ BORU (H.FREE TURUNCU) (A.YAYAN) (EKO)	100 mt.	30,17
001 165 710040 00 12	Ø40/6 ATÜ BORU (H.FREE TURUNCU) (A.YAYAN) (EKO)	100 mt.	45,25
001 165 710050 00 12	Ø50/6 ATÜ BORU (H.FREE TURUNCU) (A.YAYAN) (EKO)	100 mt.	62,01

### YENİ MUTLUSAN EKO SERİSİ MAVİ BORULAR - HALOJEN FREE - ALEV YAYAN - 320N - 6 ATÜ

001 165 710014 00 13	Ø14/6 ATÜ BORU (H.FREE MAVİ) (A.YAYAN) (EKO)	100 mt.	8,71
001 165 710016 00 13	Ø16/6 ATÜ BORU (H.FREE MAVİ) (A.YAYAN) (EKO)	100 mt.	10,06
001 165 710018 00 13	Ø18/6 ATÜ BORU (H.FREE MAVİ) (A.YAYAN) (EKO)	100 mt.	12,53
001 165 710020 00 13	Ø20/6 ATÜ BORU (H.FREE MAVİ) (A.YAYAN) (EKO)	100 mt.	13,41
001 165 710025 00 13	Ø25/6 ATÜ BORU (H.FREE MAVİ) (A.YAYAN) (EKO)	100 mt.	20,11
001 165 710032 00 13	Ø32/6 ATÜ BORU (H.FREE MAVİ) (A.YAYAN) (EKO)	100 mt.	30,17
001 165 710040 00 13	Ø40/6 ATÜ BORU (H.FREE MAVİ) (A.YAYAN) (EKO)	100 mt.	45,25
001 165 710050 00 13	Ø50/6 ATÜ BORU (H.FREE MAVİ) (A.YAYAN) (EKO)	100 mt.	62,01

### MEKS SERİSİ TURUNCU BORULAR - HALOJEN FREE - ALEV YAYAN - 320N - 6 ATÜ

001 165 506014 00 12	Ø14/6 ATÜ BORU (H.FREE) (A.YAYAN)	100 mt.	10,36
001 165 506016 00 12	Ø16/6 ATÜ BORU (H.FREE) (A.YAYAN)	100 mt.	12,60
001 165 506018 00 12	Ø18/6 ATÜ BORU (H.FREE) (A.YAYAN)	100 mt.	14,52
001 165 506020 00 12	Ø20/6 ATÜ BORU (H.FREE) (A.YAYAN)	100 mt.	16,64
001 165 506025 00 12	Ø25/6 ATÜ BORU (H.FREE) (A.YAYAN)	100 mt.	21,70
001 165 506032 00 12	Ø32/6 ATÜ BORU (H.FREE) (A.YAYAN)	100 mt.	31,70
001 165 506037 00 12	Ø37/6 ATÜ BORU (H.FREE) (A.YAYAN)	100 mt.	47,90
001 165 506040 00 12	Ø40/6 ATÜ BORU (H.FREE) (A.YAYAN)	100 mt.	54,34
001 165 506050 00 12	Ø50/6 ATÜ BORU (H.FREE) (A.YAYAN)	100 mt.	73,79
001 165 506063 00 12	Ø63/6 ATÜ BORU (H.FREE) (A.YAYAN)	100 mt.	103,34
001 165 506075 00 12	Ø75/6 ATÜ BORU (H.FREE) (A.YAYAN)	100 mt.	136,66
001 165 506090 00 12	Ø90/6 ATÜ BORU (H.FREE) (A.YAYAN)	100 mt.	205,40

### MEKS SERİSİ TURUNCU BORULAR - HALOJEN FREE - ALEV YAYAN - 750N - 10 ATÜ

001 165 510014 00 12	Ø14/10 ATÜ BORU (H.FREE) (A.YAYAN)	100 mt.	11,27
001 165 510016 00 12	Ø16/10 ATÜ BORU (H.FREE) (A.YAYAN)	100 mt.	14,01
001 165 510018 00 12	Ø18/10 ATÜ BORU (H.FREE) (A.YAYAN)	100 mt.	16,64
001 165 510020 00 12	Ø20/10 ATÜ BORU (H.FREE) (A.YAYAN)	100 mt.	20,16
001 165 510025 00 12	Ø25/10 ATÜ BORU (H.FREE) (A.YAYAN)	100 mt.	23,81
001 165 510032 00 12	Ø32/10 ATÜ BORU (H.FREE) (A.YAYAN)	100 mt.	34,52
001 165 510037 00 12	Ø37/10 ATÜ BORU (H.FREE) (A.YAYAN)	100 mt.	53,54
001 165 510040 00 12	Ø40/10 ATÜ BORU (H.FREE) (A.YAYAN)	100 mt.	62,80
001 165 510050 00 12	Ø50/10 ATÜ BORU (H.FREE) (A.YAYAN)	100 mt.	86,47
001 165 510063 00 12	Ø63/10 ATÜ BORU (H.FREE) (A.YAYAN)	100 mt.	120,24
001 165 510075 00 12	Ø75/10 ATÜ BORU (H.FREE) (A.YAYAN)	100 mt.	140,89
001 165 510090 00 12	Ø90/10 ATÜ BORU (H.FREE) (A.YAYAN)	100 mt.	233,58
001 165 510100 00 12	Ø100/10 ATÜ BORU (H.FREE) (A.YAYAN)	100 mt.	288,82
001 165 510110 00 12	Ø110/10 ATÜ BORU (H.FREE) (A.YAYAN)	100 mt.	320,91

### MEKS SERİSİ TURUNCU BORULAR - HALOJEN FREE - ALEV YAYAN - 1250N

001 165 512020 00 12	20 Ø BORU (H.FREE) (A.YAYAN)	100 mt.	34,84
001 165 512025 00 12	25 Ø BORU (H.FREE) (A.YAYAN)	100 mt.	44,18
001 165 512032 00 12	32 Ø BORU (H.FREE) (A.YAYAN)	100 mt.	65,65

### MEKS SERİSİ TURUNCU BORULAR - HALOJEN FREE - ALEV YAYMAYAN - 320N - 6 ATÜ

001 165 106014 00 12	Ø14/6 ATÜ BORU (H.FREE) (A.YAYMAYAN)	100 mt.	17,16
001 165 106016 00 12	Ø16/6 ATÜ BORU (H.FREE) (A.YAYMAYAN)	100 mt.	21,28
001 165 106018 00 12	Ø18/6 ATÜ BORU (H.FREE) (A.YAYMAYAN)	100 mt.	24,77
001 165 106020 00 12	Ø20/6 ATÜ BORU (H.FREE) (A.YAYMAYAN)	100 mt.	28,89
001 165 106025 00 12	Ø25/6 ATÜ BORU (H.FREE) (A.YAYMAYAN)	100 mt.	38,61
001 165 106032 00 12	Ø32/6 ATÜ BORU (H.FREE) (A.YAYMAYAN)	100 mt.	57,94
001 165 106037 00 12	Ø37/6 ATÜ BORU (H.FREE) (A.YAYMAYAN)	100 mt.	81,25
001 165 106040 00 12	Ø40/6 ATÜ BORU (H.FREE) (A.YAYMAYAN)	100 mt.	87,22
001 165 106050 00 12	Ø50/6 ATÜ BORU (H.FREE) (A.YAYMAYAN)	100 mt.	130,52
001 165 106063 00 12	Ø63/6 ATÜ BORU (H.FREE) (A.YAYMAYAN)	100 mt.	190,60
001 165 106075 00 12	Ø75/6 ATÜ BORU (H.FREE) (A.YAYMAYAN)	100 mt.	247,93
001 165 106090 00 12	Ø90/6 ATÜ BORU (H.FREE) (A.YAYMAYAN)	75 mt.	376,06

### MEKS SERİSİ TURUNCU BORULAR - HALOJEN FREE - ALEV YAYMAYAN - 750N - 10 ATÜ

001 165 110014 00 12	Ø14/10 ATÜ BORU (H.FREE) (A.YAYMAYAN)	100 mt.	19,19
001 165 110016 00 12	Ø16/10 ATÜ BORU (H.FREE) (A.YAYMAYAN)	100 mt.	24,02
001 165 110018 00 12	Ø18/10 ATÜ BORU (H.FREE) (A.YAYMAYAN)	100 mt.	28,89
001 165 110020 00 12	Ø20/10 ATÜ BORU (H.FREE) (A.YAYMAYAN)	100 mt.	35,75
001 165 110025 00 12	Ø25/10 ATÜ BORU (H.FREE) (A.YAYMAYAN)	100 mt.	44,10
001 165 110032 00 12	Ø32/10 ATÜ BORU (H.FREE) (A.YAYMAYAN)	100 mt.	66,18
001 165 110037 00 12	Ø37/10 ATÜ BORU (H.FREE) (A.YAYMAYAN)	100 mt.	92,10
001 165 110040 00 12	Ø40/10 ATÜ BORU (H.FREE) (A.YAYMAYAN)	100 mt.	112,01
001 165 110050 00 12	Ø50/10 ATÜ BORU (H.FREE) (A.YAYMAYAN)	100 mt.	154,16
001 165 110063 00 12	Ø63/10 ATÜ BORU (H.FREE) (A.YAYMAYAN)	100 mt.	218,46
001 165 110075 00 12	Ø75/10 ATÜ BORU (H.FREE) (A.YAYMAYAN)	100 mt.	256,16
001 165 110090 00 12	Ø90/10 ATÜ BORU (H.FREE) (A.YAYMAYAN)	75 mt.	434,70
001 165 110100 00 12	Ø100/10 ATÜ BORU (H.FREE) (A.YAYMAYAN)	50 mt.	524,52
001 165 110110 00 12	Ø110/10 ATÜ BORU (H.FREE) (A.YAYMAYAN)	50 mt.	582,80

Ürün Kodu	Ürün Adı	Kutu Mt./Ad.	Koli Adet	Fiyat (₺)
<b>MEKS SERİSİ BORULAR - HALOJEN FREE - ALEV YAYMAYAN - 1250N</b>				
001 165 112020 00 12	20 Ø BORU (H.FREE)(A.YAYMAYAN)	100 mt.		63,71
001 165 112025 00 12	25 Ø BORU (H.FREE)(A.YAYMAYAN)	100 mt.		81,25
001 165 112032 00 12	32 Ø BORU (H.FREE)(A.YAYMAYAN)	100 mt.		121,80
<b>MEKS SERİSİ TURUNCU BORU - HALOJEN FREE - ALEV YAYAN - TELLİ - 320N - 6 ATÜ</b>				
001 165 906014 00 12	Ø14/6 ATÜ BORU(H.FREE)(A.YAYAN)(TELLİ)(TURUNCU)	100 mt.		11,14
001 165 906016 00 12	Ø16/6 ATÜ BORU(H.FREE)(A.YAYAN)(TELLİ)(TURUNCU)	100 mt.		13,38
001 165 906018 00 12	Ø18/6 ATÜ BORU(H.FREE)(A.YAYAN)(TELLİ)(TURUNCU)	100 mt.		15,31
001 165 906020 00 12	Ø20/6 ATÜ BORU(H.FREE)(A.YAYAN)(TELLİ)(TURUNCU)	100 mt.		17,42
001 165 906025 00 12	Ø25/6 ATÜ BORU(H.FREE)(A.YAYAN)(TELLİ)(TURUNCU)	100 mt.		22,48
001 165 906032 00 12	Ø32/6 ATÜ BORU(H.FREE)(A.YAYAN)(TELLİ)(TURUNCU)	100 mt.		32,48
001 165 906037 00 12	Ø37/6 ATÜ BORU(H.FREE)(A.YAYAN)(TELLİ)(TURUNCU)	100 mt.		48,69
001 165 906040 00 12	Ø40/6 ATÜ BORU(H.FREE)(A.YAYAN)(TELLİ)(TURUNCU)	100 mt.		55,13
<b>MEKS SERİSİ TURUNCU BORU - HALOJEN FREE - ALEV YAYAN - TELLİ - 750N - 10 ATÜ</b>				
001 165 910014 00 12	Ø14/10 ATÜ BORU(H.FREE)(A.YAYAN)(TELLİ)(TURUNCU)	100 mt.		12,06
001 165 910016 00 12	Ø16/10 ATÜ BORU(H.FREE)(A.YAYAN)(TELLİ)(TURUNCU)	100 mt.		14,79
001 165 910018 00 12	Ø18/10 ATÜ BORU(H.FREE)(A.YAYAN)(TELLİ)(TURUNCU)	100 mt.		17,42
001 165 910020 00 12	Ø20/10 ATÜ BORU(H.FREE)(A.YAYAN)(TELLİ)(TURUNCU)	100 mt.		20,94
001 165 910025 00 12	Ø25/10 ATÜ BORU(H.FREE)(A.YAYAN)(TELLİ)(TURUNCU)	100 mt.		24,59
001 165 910032 00 12	Ø32/10 ATÜ BORU(H.FREE)(A.YAYAN)(TELLİ)(TURUNCU)	100 mt.		35,30
001 165 910037 00 12	Ø37/10 ATÜ BORU(H.FREE)(A.YAYAN)(TELLİ)(TURUNCU)	100 mt.		54,32
001 165 910040 00 12	Ø40/10 ATÜ BORU(H.FREE)(A.YAYAN)(TELLİ)(TURUNCU)	100 mt.		63,58
<b>MEKS SERİSİ BORULAR - HALOJEN FREE - ALEV YAYMAYAN - TELLİ - 320N - 6 ATÜ</b>				
001 165 306014 00 12	Ø14/6 ATÜ BORU(H.FREE)(A.YAYMAYAN)(TELLİ)(TURUNCU)	100 mt.		18,06
001 165 306016 00 12	Ø16/6 ATÜ BORU(H.FREE)(A.YAYMAYAN)(TELLİ)(TURUNCU)	100 mt.		22,18
001 165 306018 00 12	Ø18/6 ATÜ BORU(H.FREE)(A.YAYMAYAN)(TELLİ)(TURUNCU)	100 mt.		25,68
001 165 306020 00 12	Ø20/6 ATÜ BORU(H.FREE)(A.YAYMAYAN)(TELLİ)(TURUNCU)	100 mt.		29,79
001 165 306025 00 12	Ø25/6 ATÜ BORU(H.FREE)(A.YAYMAYAN)(TELLİ)(TURUNCU)	100 mt.		40,20
001 165 306032 00 12	Ø32/6 ATÜ BORU(H.FREE)(A.YAYMAYAN)(TELLİ)(TURUNCU)	100 mt.		60,89
001 165 306037 00 12	Ø37/6 ATÜ BORU(H.FREE)(A.YAYMAYAN)(TELLİ)(TURUNCU)	100 mt.		82,15
001 165 306040 00 12	Ø40/6 ATÜ BORU(H.FREE)(A.YAYMAYAN)(TELLİ)(TURUNCU)	100 mt.		91,19
<b>MEKS SERİSİ BORULAR - HALOJEN FREE - ALEV YAYMAYAN - TELLİ - 750N - 10 ATÜ</b>				
001 165 310014 00 12	Ø14/10 ATÜ BORU(H.FREE)(A.YAYMAYAN)(TELLİ)(TURUNCU)	100 mt.		20,10
001 165 310016 00 12	Ø16/10 ATÜ BORU(H.FREE)(A.YAYMAYAN)(TELLİ)(TURUNCU)	100 mt.		24,93
001 165 310018 00 12	Ø18/10 ATÜ BORU(H.FREE)(A.YAYMAYAN)(TELLİ)(TURUNCU)	100 mt.		29,79
001 165 310020 00 12	Ø20/10 ATÜ BORU(H.FREE)(A.YAYMAYAN)(TELLİ)(TURUNCU)	100 mt.		36,65
001 165 310025 00 12	Ø25/10 ATÜ BORU(H.FREE)(A.YAYMAYAN)(TELLİ)(TURUNCU)	100 mt.		45,00
001 165 310032 00 12	Ø32/10 ATÜ BORU(H.FREE)(A.YAYMAYAN)(TELLİ)(TURUNCU)	100 mt.		67,08
001 165 310037 00 12	Ø37/10 ATÜ BORU(H.FREE)(A.YAYMAYAN)(TELLİ)(TURUNCU)	100 mt.		93,00
001 165 310040 00 12	Ø40/10 ATÜ BORU(H.FREE)(A.YAYMAYAN)(TELLİ)(TURUNCU)	100 mt.		112,91
<b>PLASTİK BORULAR</b>				
001 045 000014 30 00	14 MM KALIN BOY BORU	102 mt.	510 mt.	8,63
001 045 000018 30 00	18 MM KALIN BOY BORU	102 mt.	510 mt.	10,25
001 045 000026 30 00	26 MM KALIN BOY BORU	51 mt.	255 mt.	17,54
001 045 000037 30 00	37 MM KALIN BOY BORU	30 mt.		32,52
001 045 010014 00 11	14 MM KANGAL (NORMAL)	100 mt.		8,63
001 045 010018 00 11	18 MM KANGAL (NORMAL)	100 mt.		10,25
001 045 010026 00 11	26 MM KANGAL (NORMAL)	50 mt.		17,54
001 045 010037 00 11	37 MM KANGAL (NORMAL)	50 mt.		39,72
001 045 020014 00 00	14 MM KANGAL (KAUÇUK)	100 mt.		8,94
001 045 020018 00 00	18 MM KANGAL (KAUÇUK)	100 mt.		10,76
001 045 020026 00 00	26 MM KANGAL (KAUÇUK)	50 mt.		17,31
001 045 020037 00 00	37 MM KANGAL (KAUÇUK)	50 mt.		32,12
001 045 030014 00 00	14 MM KANGAL (KAUÇUK) (KALIN)	100 mt.		10,11
001 045 030018 00 00	18 MM KANGAL (KAUÇUK) (KALIN)	100 mt.		11,35
<b>PLASTİK DİRSEK VE MUFLAR</b>				
127 051 000014	PLASTİK 14 Ø DİRSEK	100 ad.	2000	3,04
127 051 000018	PLASTİK 18 Ø DİRSEK	100 ad.	1000	3,97
127 051 000026	PLASTİK 26 Ø DİRSEK	100 ad.	500	6,78
<b>POLİETİLEN SİYAH YERALTI BORULAR - 450N</b>				
001 165 406014 00 11	14/6 ATÜ POLİETİLEN BORU (SİYAH)	100 mt.		8,75
001 165 406016 00 11	16/6 ATÜ POLİETİLEN BORU (SİYAH)	100 mt.		10,03
001 165 406018 00 11	18/6 ATÜ POLİETİLEN BORU (SİYAH)	100 mt.		11,19
001 165 406020 00 11	20/6 ATÜ POLİETİLEN BORU (SİYAH)	100 mt.		12,90
001 165 406025 00 11	25/6 ATÜ POLİETİLEN BORU (SİYAH)	100 mt.		16,63
001 165 406032 00 11	32/6 ATÜ POLİETİLEN BORU (SİYAH)	100 mt.		25,26
001 165 406037 00 11	37/6 ATÜ POLİETİLEN BORU (SİYAH)	100 mt.		37,48
001 165 406040 00 11	40/6 ATÜ POLİETİLEN BORU (SİYAH)	100 mt.		42,46
001 165 406050 00 11	50/6 ATÜ POLİETİLEN BORU (SİYAH)	100 mt.		57,30
001 165 406063 00 11	63/6 ATÜ POLİETİLEN BORU (SİYAH)	100 mt.		79,81
001 165 406075 00 11	75/6 ATÜ POLİETİLEN BORU (SİYAH)	100 mt.		108,90
001 165 406090 00 11	90/6 ATÜ POLİETİLEN BORU (SİYAH)	75 mt.		164,81
<b>POLİETİLEN SİYAH YER ALTI BORULAR - 750N</b>				
001 165 410014 00 11	14/10 ATÜ POLİETİLEN BORU (SİYAH)	100 mt.		9,39
001 165 410016 00 11	16/10 ATÜ POLİETİLEN BORU (SİYAH)	100 mt.		10,56
001 165 410018 00 11	18/10 ATÜ POLİETİLEN BORU (SİYAH)	100 mt.		12,47
001 165 410020 00 11	20/10 ATÜ POLİETİLEN BORU (SİYAH)	100 mt.		15,23
001 165 410025 00 11	25/10 ATÜ POLİETİLEN BORU (SİYAH)	100 mt.		18,80
001 165 410032 00 11	32/10 ATÜ POLİETİLEN BORU (SİYAH)	100 mt.		28,05
001 165 410037 00 11	37/10 ATÜ POLİETİLEN BORU (SİYAH)	100 mt.		41,02
001 165 410040 00 11	40/10 ATÜ POLİETİLEN BORU (SİYAH)	100 mt.		46,93
001 165 410050 00 11	50/10 ATÜ POLİETİLEN BORU (SİYAH)	100 mt.		67,01
001 165 410063 00 11	63/10 ATÜ POLİETİLEN BORU (SİYAH)	100 mt.		94,61
001 165 410075 00 11	75/10 ATÜ POLİETİLEN BORU (SİYAH)	100 mt.		114,69
001 165 410090 00 11	90/10 ATÜ POLİETİLEN BORU (SİYAH)	100 mt.		190,42
001 165 410100 00 11	100/10 ATÜ POLİETİLEN BORU (SİYAH)	100 mt.		230,39
001 165 410110 00 11	110/10 ATÜ POLİETİLEN BORU (SİYAH)	75 mt.		257,65

**HF**  
HALOGEN  
FREE

001 046 130107 00 11



001 046 170102 00 11



001 046 130101 00 11



001 046 170101 00 11



001 046 130102 00 11

001 046 000001 00 11



001 046 131201 00 12

001 046 161201 00 12

001 046 131202 00 12

001 046 120101 00 12

001 046 120103 00 12

001 046 120100 00 12

001 046 131201 00 12

001 046 161201 00 12

000 700 000215 00 12

000 700 000214 00 14

000 700 000036 00 14

000 700 000035 00 12

000 700 000039 00 12

000 700 000256 00 12

001 046 000103 00 00

001 046 000103 00 11

001 046 021212 00 11

Ürün Kodu	Ürün Adı	Kutu Mt./Ad.	Koli Adet	Fiyat (₺)
<b>PLASTİK KASA - BUAT - TAKOZLAR</b>				
001 046 130102 00 11	NORM KASA	100 ad.	1000	3,61
001 046 130101 00 11	NORM BUAT (14-18 ÇIKIŞLI)	50 ad.	500	8,13
001 046 130105 00 11	NORM BUAT KAPAKSIZ	50 ad.	500	6,10
001 046 160102 00 11	GEÇMELİ PLASTİK KASA	100 ad.	400	11,31
001 046 160101 00 11	GEÇMELİ DERİN KASA	100 ad.	500	7,23
001 046 130107 00 11	GEÇMELİ DERİN KASA KAPAKSIZ	100 ad.	500	5,42
001 046 120101 00 11	ALÇIPAN KASA 1'Lİ	75 ad.	300	16,41
001 046 120102 00 11	ALÇIPAN KASA 2'Lİ	50 ad.	200	24,11
001 046 120103 00 11	ALÇIPAN KASA 3'Lİ	25 ad.	100	34,68
001 046 120100 00 11	GEÇMELİ ALÇ.KASA SİYAH	50 ad.	300	11,07
001 046 170101 00 11	TÜNEL KASA	100 ad.	500	19,37
001 046 170102 00 11	TÜNEL BUAT	50 ad.	300	13,06
001 046 000001 00 11	PLASTİK TAKOZ (14-18 ÇIKIŞLI)	100 ad.	1000	5,78
<b>TURUNCU KASA VE BUATLAR - HALOJEN FREE - ALEV YAYAN</b>				
001 046 130202 00 12	NORM KASA (TURUNCU) (H.FREE) (ALEV YAYAN)	100 ad.	1000	7,45
001 046 130201 00 12	NORM BUAT (TURUNCU) (H.FREE) (ALEV YAYAN)	50 ad.	500	14,01
001 046 160201 00 12	GEÇMELİ DERİN KASA (TURUNCU) (H.FREE) (ALEV YAYAN)	100 ad.	500	13,55
<b>TURUNCU KASA VE BUATLAR - ALEV YAYAN</b>				
001 046 130102 00 12	NORM KASA (TURUNCU)(ALEV YAYAN)	100 ad.	1000	4,97
001 046 130101 00 12	NORM BUAT (TURUNCU)(ALEV YAYAN)	50 ad.	500	10,84
001 046 160102 00 12	GEÇMELİ PLASTİK KASA (TURUNCU)(ALEV YAYAN)	100 ad.	400	12,07
001 046 160101 00 12	GEÇMELİ DERİN KASA (TURUNCU)(ALEV YAYAN)	100 ad.	500	12,50
001 046 170101 00 12	TÜNEL KASA (TURUNCU)(ALEV YAYAN)	100 ad.	500	18,97
001 046 170102 00 12	TÜNEL BUAT (TURUNCU)(ALEV YAYAN)	50 ad.	300	13,62
001 046 120101 00 12	ALÇIPAN KASA 1'Lİ (TURUNCU)(ALEV YAYAN)	75 ad.	300	17,48
001 046 120102 00 12	ALÇIPAN KASA 2'Lİ (TURUNCU)(ALEV YAYAN)	50 ad.	200	26,00
001 046 120103 00 12	ALÇIPAN KASA 3'LÜ (TURUNCU)(ALEV YAYAN)	25 ad.	100	37,13
001 046 120100 00 12	GEÇMELİ ALÇIPAN KASA (TURUNCU)(ALEV YAYAN)	50 ad.	300	14,23
<b>TURUNCU KASA VE BUATLAR - ALEV YAYMAYAN</b>				
001 046 131102 00 12	NORM KASA (TURUNCU)(ALEV YAYMAYAN)	100 ad.	1000	6,88
001 046 131101 00 12	NORM BUAT (TURUNCU)(ALEV YAYMAYAN)	50 ad.	500	13,05
001 046 161102 00 12	GEÇMELİ PLASTİK KASA (TURUNCU)(ALEV YAYMAYAN)	100 ad.	400	19,18
001 046 161101 00 12	GEÇMELİ DERİN KASA (TURUNCU)(ALEV YAYMAYAN)	100 ad.	500	15,36
001 046 210002 00 12	TÜNEL KASA (TURUNCU)(ALEV YAYMAYAN)	100 ad.	500	25,12
001 046 210003 00 12	TÜNEL BUAT (TURUNCU)(ALEV YAYMAYAN)	50 ad.	300	20,24
001 046 121101 00 12	ALÇIPAN KASA 1'Lİ (TURUNCU)(ALEV YAYMAYAN)	75 ad.	300	19,96
001 046 121102 00 12	ALÇIPAN KASA 2'Lİ (TURUNCU)(ALEV YAYMAYAN)	50 ad.	200	30,21
001 046 121103 00 12	ALÇIPAN KASA 3'LÜ (TURUNCU)(ALEV YAYMAYAN)	25 ad.	100	44,00
001 046 121100 00 12	GEÇMELİ ALÇIPAN KASA (TURUNCU)(ALEV YAYMAYAN)	50 ad.	300	17,64
<b>BETON DUVAR ANAHTAR KASALARI - ALEV YAYAN</b>				
000 700 000037 00 14	BUAT ARKA KAPAK SARI (ALEV YAYAN)	50 ad.	500	5,00
000 700 000035 00 12	BUAT GÖVDE 60'LİK TURUNCU (ALEV YAYAN)	50 ad.	350	10,23
000 700 000256 00 14	KALIBA TESPİT ELEMANI SARI (ALEV YAYAN)		250	6,49
000 700 000039 00 12	SIĞ BRÜT ANAH. KASASI TURUNCU (ALEV YAYAN)	100 ad.	500	15,74
000 700 000036 00 14	KONİK GÖVDE SARI (ALEV YAYAN)	50 ad.	250	9,13
000 700 000214 00 14	APLİK 20'LİK SARI (ALEV YAYAN)	100 ad.	1000	4,38
000 700 000215 00 12	APLİK EĞİK BAĞLANTI DIRSEĞİ TURUNCU (ALEV YAYAN)	100 ad.	1000	3,87
<b>BETON DUVAR ANAHTAR KASALARI - ALEV YAYMAYAN</b>				
000 700 200037 00 14	BUAT ARKA KAPAK SARI (ALEV YAYMAYAN)	50 ad.	500	6,21
000 700 200035 00 12	BUAT GÖVDE 60'LİK TURUNCU (ALEV YAYMAYAN)	50 ad.	350	12,43
000 700 200256 00 14	KALIBA TESPİT ELEMANI SARI (ALEV YAYMAYAN)		250	8,80
000 700 200039 00 12	SIĞ BRÜT ANAH. KASASI TURUNCU (ALEV YAYMAYAN)	100 ad.	500	25,92
000 700 200036 00 14	KONİK GÖVDE SARI (ALEV YAYMAYAN)	50 ad.	250	13,05
000 700 200214 00 14	APLİK 20'LİK SARI (ALEV YAYMAYAN)	100 ad.	1000	4,75
000 700 200215 00 12	APLİK EĞİK BAĞLANTI DIRSEĞİ TURUNCU (ALEV YAYMAYAN)	100 ad.	1000	6,59
<b>KARE BUAT</b>				
001 046 021010 00 11	10X10 KARE BUAT (SİYAH)	10 ad.	300	59,33
001 046 021212 00 11	12X12 KARE BUAT (SİYAH)	10 ad.	200	62,23
001 046 021515 00 11	15X15 KARE BUAT (SİYAH)	10 ad.	120	93,35
001 046 022020 00 11	20X20 KARE BUAT (SİYAH)	10 ad.	70	115,91
001 046 000103 00 11	ANTİGRON BUAT 3'LÜ PLASTİK (SİYAH)	10 ad.	240	42,94
001 046 000104 00 11	ANTİGRON BUAT 4'LÜ PLASTİK (SİYAH)	10 ad.	240	50,38
001 046 000103 00 00	ANTİGRON BUAT 3'LÜ PLASTİK (BEYAZ)	10 ad.	240	43,30
001 046 000104 00 00	ANTİGRON BUAT 4'LÜ PLASTİK (BEYAZ)	10 ad.	240	51,50



## KABLO KROŞELERİ



### ÇOK AMAÇLI KABLO KROŞESİ

Ürün Kodu	Ürün Adı	Uzunluk	Kutu/Koli Adedi	EURO (€)
888 888 530430	1/2 ÇOK AMAÇLI KABLO KROŞESİ	156mm	100	1,1012
888 888 530450	1/1 ÇOK AMAÇLI KABLO KROŞESİ	249mm	50	1,7775



Kabloları hizalamak için kullanılır.



### DÜBELLİ KABLO TOPLAYICI

Ürün Kodu	Ürün Adı	Kapasite*	YükseklikXDeinlikXGenişlik (mm)	Kutu/Koli Adedi	EURO (€)
888 888 530530	TEK TARAFLI DÜBELLİ KABLO TOPLAYICI	max. 40	95,5X27X46	100	2,0309
888 888 530550	ÇİFT TARAFLI DÜBELLİ KABLO TOPLAYICI	max. 80	95,5X27X88	100	3,0373

Ø 10 mm'lik 80 adede kadar kabloların toplanması için kullanılır.



### TABAN MONTAJ GEÇMELİ KABLO TOPLAYICI

Ürün Kodu	Ürün Adı	Kapasite*	YükseklikXGenişlik (mm)	Kutu/Koli Adedi	EURO (€)
888 888 530590	TABAN MONTAJ GEÇMELİ KABLO TOPLAYICI	max. 35	95,7X46	100	2,0309

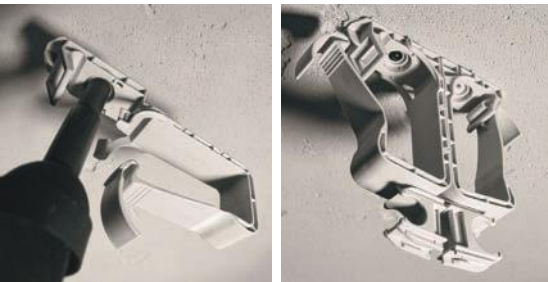

35 adede kadar (Ø10mm) kabloların ortak kullanımı ile hızlı ve kolay şekilde çoklu halde taşınması için doğrudan sabitlenir veya metal yada ahşap üzerine vidalanır.



## BORU MONTAJI

Farklı tip yüzeylerdeki kanallar için sabitleme elemanları



### ÇOK AMAÇLI BORU KROŞELERİ

Ürün Kodu	Ürün Adı	Ebat Ø mm	Kutu/Koli Adedi	EURO (€)
888 888 531020	16 MM ÇOK AMAÇLI BORU KROŞESİ	16	100 / 3,200	0,5032
888 888 531080	20 MM ÇOK AMAÇLI BORU KROŞESİ	20	100 / 2,400	0,5925
888 888 531120	25 MM ÇOK AMAÇLI BORU KROŞESİ	25	100 / 2,000	0,8058
888 888 531160	32 MM ÇOK AMAÇLI BORU KROŞESİ	32	50 / 1,600	1,0373
888 888 531200	40 MM ÇOK AMAÇLI BORU KROŞESİ	40	50 / 1,100	1,6153
888 888 531220	50 MM ÇOK AMAÇLI BORU KROŞESİ	50	50 / 700	2,0441



Tüm yüzeylerde farklı boyuttaki montaj boruları için kullanılır.



### ÇOK AMAÇLI BORU KROŞE ÜST KAPAK

Ürün Kodu	Ürün Adı	Ebat Ø mm	Kutu/Koli Adedi	EURO (€)
888 888 534020	16 MM ÇOK AMAÇLI BORU KROŞE ÜST KAPAK	16	100 / 7,200	0,3500
888 888 534080	20 MM ÇOK AMAÇLI BORU KROŞE ÜST KAPAK	20	100 / 6,000	0,4029
888 888 534120	25 MM ÇOK AMAÇLI BORU KROŞE ÜST KAPAK	25	100 / 3,600	0,5761
888 888 534160	32 MM ÇOK AMAÇLI BORU KROŞE ÜST KAPAK	32	50 / 2,100	0,7985
888 888 534200	40 MM ÇOK AMAÇLI BORU KROŞE ÜST KAPAK	40	50 / 1,500	0,9097
888 888 534220	50 MM ÇOK AMAÇLI BORU KROŞE ÜST KAPAK	50	50 / 1000	1,0501

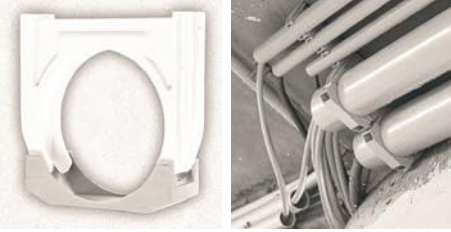

Kapalı kelepçe gereksinimleri karşılanır ve boruların dışarı kaymasını önler.



### AYARLANABİLİR BORU KROŞESİ

Ürün Kodu	Ürün Adı	Kutu/Koli Adedi	EURO (€)
888 888 533310	16-20 MM AYARLANABİLİR BORU KROŞESİ	100 / 3,000	0,4667
888 888 533320	20-25 MM AYARLANABİLİR BORU KROŞESİ	100 / 2,000	0,5797
888 888 533330	25-32 MM AYARLANABİLİR BORU KROŞESİ	100 / 1,200	0,7912
888 888 533340	32-40 MM AYARLANABİLİR BORU KROŞESİ	50 / 800	1,0191
888 888 533350	40-50 MM AYARLANABİLİR BORU KROŞESİ	50 / 500	1,5825



Esnek milimetre hassasiyetinde her yüzeye boru montajı sağlar. Her tip, en az iki kanal boutu için uygundur.



## KROŞE APARATLARI



### KROŞE DUVARA SABİTLEME APARATI

Ürün Kodu	Ürün Adı	Dübel Uzunluk mm	Kutu/Koli Adedi	EURO (€)
888 888 531280	KROŞE DUVARA SABİTLEME APARATI (11 MM DÜBEL)	11	200 / 10,800	0,3063
888 888 531300	KROŞE DUVARA SABİTLEME APARATI (27 MM DÜBEL)	27	100 / 4,800	0,3519
888 888 531320	KROŞE DUVARA SABİTLEME APARATI (42 MM DÜBEL)	42	100 / 3,000	0,4029
888 888 531340	KROŞE DUVARA SABİTLEME APARATI (80 MM DÜBEL)	80	50 / 1,800	0,8660



### KROŞE SAC TAVA'YA SABİTLEME APARATI (TAK ÇEVİR)

Ürün Kodu	Ürün Adı	Kutu/Koli Adedi	EURO (€)
888 888 531430	KROŞE SAC TAVA'YA SABİTLEME APARATI (TAK ÇEVİR)	200 / 3,000	0,3573

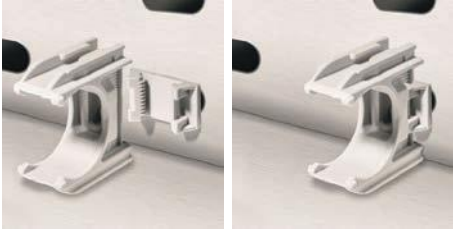

Oluklu delikli tüm kablo kanallarının kablo kanalı montajı için 0,5 ila 1,1 mm sac kalınlığı ile kullanılır.



### KROŞE SAC TAVA'YA SABİTLEME APARATI (DÜBELLİ)

Ürün Kodu	Ürün Adı	Kutu/Koli Adedi	EURO (€)
888 888 534430	KROŞE SAC TAVA'YA SABİTLEME APARATI (DÜBELLİ)	200 / 3,000	0,3573

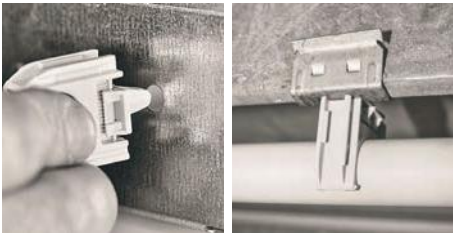

Yuvarlak delikli tüm kablo kanallarının kablo kanalı montajı için 0,5 ila 1,1 mm sac kalınlığı ile kullanılır.



### KROŞE SAC TAVA TİJ'E SABİTLEME APARATI (M8-M10)

Ürün Kodu	Ürün Adı	Dişli Çubuk Ebat Ø mm	Kutu/Koli Adedi	EURO (€)
888 888 531460	KROŞE SAC TAVA TİJ'E SABİTLEME APARATI (M8-M10)	M8-M10	100 / 3,500	0,4011

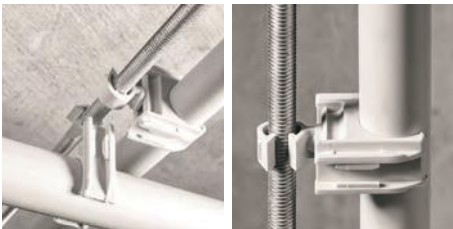

Kombinasyon halinde M8-M10 dişli çubuklara boruları sabitlemek için kullanılır.

Yalnızca kanalların dişli bir çubuğa paralel olarak sabitlenmesi ve dik açıda kanal sabitleme için uygundur.



## ALÇIPAN MONTAJI



### SİRAL SABİTLEME KROŞELERİ

Ürün Kodu	Ürün Adı	Boru Ø mm	Kutu/Koli Adedi	EURO (€)
888 888 509116	16 MM SİRAL SABİTLEME KROŞELERİ	16	100 / 3,200	1,0993
888 888 509120	20 MM SİRAL SABİTLEME KROŞELERİ	20	75 / 2,400	1,2379
888 888 509125	25 MM SİRAL SABİTLEME KROŞELERİ	25	50 / 1,600	1,3655
888 888 509132	32 MM SİRAL SABİTLEME KROŞELERİ	32	25 / 800	1,4439
888 888 509140	40 MM SİRAL SABİTLEME KROŞELERİ	40	20 / 640	1,5150

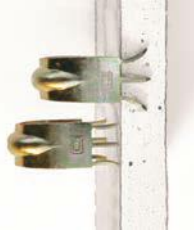

Alçıpanın iç tarafında ve inşaat ahşaplarında kanalları ve kablo hatlarını sabitlemek için kullanılır.

**!** Yangın korumasına mükemmel uyum sağlar.



### METAL ALÇIPAN DÜBEL

Ürün Kodu	Ürün Adı	Vida Ø mm	Uzunluk	Kutu/Koli Adedi	EURO (€)
888 888 509080	3,5-4,5Ø 30 MM METAL ALÇIPAN DÜBEL	3,5 – 4,5	30	100 / 5,000	0,4248
888 888 509082	3,5-4,5Ø 43 MM METAL ALÇIPAN DÜBEL	3,5 – 4,5	43	100 / 3,000	0,8933

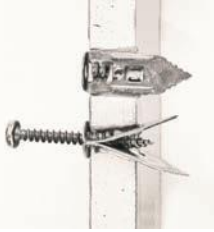

Elektrikli ekipmanların alçıpana ve ahşap yüzü levhalara bağlanması için kullanılır.  
Malzeme galvanizli yay çeliğidir.

**!** Yangın korumasına mükemmel uyum sağlar.



### AYARLANABİLİR DÜBELLİ BORU KROŞELERİ

Ürün Kodu	Ürün Adı	Sıkıştırma aralığı kanal boyutu Ø mm	Dübel Uzunluğu Ø mm	Kutu/Koli Adedi	EURO (€)
888 888 512330	16-20 MM AYARLANABİLİR KISA BOY DÜBELLİ BORU KROŞE	16-20	11 ***	100 / 3,200	0,3136
888 888 512340	20-25 MM AYARLANABİLİR KISA BOY DÜBELLİ BORU KROŞE	20-25	11 ***	100 / 2,400	0,3446
888 888 512350	25-32 MM AYARLANABİLİR KISA BOY DÜBELLİ BORU KROŞE	25-32	11 ***	50 / 1,200	0,4175
888 888 512430	16-20 MM AYARLANABİLİR ORTA BOY DÜBELLİ BORU KROŞE	16-20	25 ****	100 / 3,200	0,3154
888 888 512440	20-25 MM AYARLANABİLİR ORTA BOY DÜBELLİ BORU KROŞE	20-25	25 ****	100 / 2,200	0,3519
888 888 512450	25-32 MM AYARLANABİLİR ORTA BOY DÜBELLİ BORU KROŞE	25-32	25 ****	100 / 1,200	0,4284
888 888 512640	32-42 MM AYARLANABİLİR ORTA BOY DÜBELLİ BORU KROŞE	32-42	25 ****	50 / 700	0,6290
888 888 512530	16-20 MM AYARLANABİLİR UZUN BOY DÜBELLİ BORU KROŞE	16-20	55 *	100 / 2,400	0,3245
888 888 512540	20-25 MM AYARLANABİLİR UZUN BOY DÜBELLİ BORU KROŞE	20-25	55 *	100 / 1,600	0,3592
888 888 512550	25-32 MM AYARLANABİLİR UZUN BOY DÜBELLİ BORU KROŞE	25-32	55 *	50 / 1,000	0,4357
888 888 512650	32-42 MM AYARLANABİLİR UZUN BOY DÜBELLİ BORU KROŞE	32-42	55 *	50 / 600	0,6417



Esnek boruların sıvasız olarak alçıpan, beton ve içi boş tuğla üzerine kolayca döşenmesi için kullanılır.

İç taraftaki entegre uç kelepçe boru arasında gerilme sağlayarak iki kelepçenin daha kolay yerleşmesini sağlar.



## ÖZEL UYGULAMALAR

Yalıtılmış tavan ve duvarlardaki sabitlemeler. Bağlantı kutu sabitleme aksesuarları



### ÇOK AMAÇLI DÜBEL

Ürün Kodu	Ürün Adı	Yalıtım Kalınlık (cm)	Toplam Uzunluk (cm)	Disk Çapı Ø (mm)	Kutu/Koli Adedi	EURO (€)
888 888 531510	ÇOK AMAÇLI 10 MM DÜBEL (BOY 8 CM)(DISKØ 6 CM)	3-4	8	6	225	1,4129
888 888 531530	ÇOK AMAÇLI 10 MM DÜBEL (BOY 10 CM)(DISKØ 6 CM)	4-6	10	6	175	1,4421
888 888 531550	ÇOK AMAÇLI 10 MM DÜBEL (BOY 13 CM)(DISKØ 6 CM)	6-8	13	6	150	1,5059
888 888 531570	ÇOK AMAÇLI 10 MM DÜBEL (BOY 15 CM)(DISKØ 6 CM)	8-10	15	6	125	1,5861
888 888 531590	ÇOK AMAÇLI 10 MM DÜBEL (BOY 17.5 CM)(DISKØ 6 CM)	10-14	17,5	6	75	1,6900
888 888 531600	ÇOK AMAÇLI 10 MM DÜBEL (BOY 21 CM)(DISKØ 5 CM)	16	21	5	120	1,9507
888 888 531610	ÇOK AMAÇLI 10 MM DÜBEL (BOY 25 CM)(DISKØ 5 CM)	15-20	25	5	75	2,2625
888 888 531630	ÇOK AMAÇLI 10 MM DÜBEL (BOY 30 CM)(DISKØ 5 CM)	20-25	30	5	75	2,6800
888 888 531650	ÇOK AMAÇLI 10 MM DÜBEL (BOY 35 CM)(DISKØ 5 CM)	25-30	35	5	70	2,8240



Montaj talimatları: minimum ayar derinliği = 45 mm  
Delme çapı = 10 mm. Minimum delme derinliği = toplam uzunluk DHI + 10 mm – Yalıtım kalınlığı  
Önerilen vidalar: Çelik levha veya sunta vidaları 4 mm, DHI cinsinden vidalama derinliği = 10–15 mm.



Elektrikli ekipmanların basit montajı için kullanılır.

### BUATI SAC TAVA'YA SABİTLEME APARATI

Ürün Kodu	Ürün Adı	Kutu/Koli Adedi	EURO (€)
888 888 531450	BUATI SAC TAVA'YA SABİTLEME APARATI	200 / 3,000	0,5123



Boru kanallarının ve bağlantı kutularının montajında zaman kazandırır.



### ÇOK AMAÇLI KROŞE DUVARA MONTAJ APARATI

Ürün Kodu	Ürün Adı	Kutu/Koli Adedi	EURO (€)
888 888 531440	ÇOK AMAÇLI KROŞE DUVARA MONTAJ APARATI	100 / 2,000	0,6053



Ürün Kodu	Ürün Adı	Kutu Mt./Ad.	Koli Adet	Fiyat (₺)
<b>TURUNCU KARE BUAT</b>				
001 046 021010 00 12	10X10 KARE BUAT TURUNCU	10 ad.	300	59,92
001 046 021212 00 12	12X12 KARE BUAT TURUNCU	10 ad.	200	65,79
001 046 021515 00 12	15X15 KARE BUAT TURUNCU	10 ad.	120	95,38
001 046 022020 00 12	20X20 KARE BUAT TURUNCU	10 ad.	70	121,18
001 046 000103 00 12	ANTİGRON BUAT 3'LÜ TURUNCU	10 ad.	240	43,36
001 046 000104 00 12	ANTİGRON BUAT 4'LÜ TURUNCU	10 ad.	240	50,10



001 046 021212 00 12

<b>TURUNCU KARE BUAT - ALEV YAYMAYAN</b>				
001 046 051010 00 12	KARE BUAT TURUNCU(10X10) (A.YAYMAYAN)	10 ad.	300	65,96
001 046 051212 00 12	KARE BUAT TURUNCU(12X12) (A.YAYMAYAN)	10 ad.	200	70,89
001 046 051515 00 12	KARE BUAT TURUNCU(15X15) (A.YAYMAYAN)	10 ad.	120	110,86
001 046 052020 00 12	KARE BUAT TURUNCU(20X20) (A.YAYMAYAN)	10 ad.	70	145,65



000 700 000047 00 00



<b>LÜKS BUAT KAPAKLARI</b>				
126 046 180001	LÜKS BUAT KAPAĞI(BOMBELİ-PLS. AYAK)	100 ad.	1000	4,29
126 046 180003	LÜKS BUAT KAPAĞI(DÜZ PLS. AYAK)	100 ad.	1000	4,29
126 046 180004	LÜKS BUAT KAPAĞI(BOMB.PLS.AYAK)VİDALI	100 ad.	1000	12,65

126 046 180003



<b>KARE BUAT KAPAKLARI</b>				
000 700 000043 00 00	10X10 KARE BUAT KAPAĞI	1 ad.	300	14,27
000 700 000045 00 00	12X12 KARE BUAT KAPAĞI	1 ad.	350	17,96
000 700 000047 00 00	15X15 KARE BUAT KAPAĞI	1 ad.	260	25,41
000 700 000049 00 00	20X20 KARE BUAT KAPAĞI	1 ad.	140	47,15

126 046 180004



126 046 180001

<b>MUTLUSAN BETON ÇİVİLİ KROŞELER</b>					
032 048 070000	NO:0 BETON ÇİVİLİ KROŞE(0.75 YASSIKORD.)	MUTLUSAN	1000 ad.	20000	0,41
032 048 070001	NO:1 BETON ÇİVİLİ KROŞE(0.75 YASSIKORD.)	MUTLUSAN	1000 ad.	20000	0,41
032 048 070002	NO:2 BETON ÇİVİLİ KROŞE(0.75 YASSIKORD.)	MUTLUSAN	1000 ad.	20000	0,41
032 048 070003	NO:3 BETON ÇİVİLİ KROŞE (2X1.5-3X1.5)	MUTLUSAN	1000 ad.	20000	0,54
032 048 070004	NO:4 BETON ÇİVİLİ KROŞE (2X4)	MUTLUSAN	1000 ad.	20000	0,56
032 048 070005	NO:5 BETON ÇİVİLİ KROŞE (2X4-4X4)	MUTLUSAN	1000 ad.	10000	0,77
032 048 070006	NO:6 BETON ÇİVİLİ KROŞE (2X6)	MUTLUSAN	1000 ad.	10000	0,77
032 048 070007	NO:7 BETON ÇİVİLİ KROŞE (4X10)	MUTLUSAN	1000 ad.	5000	1,36
032 048 070008	NO:8 BETON ÇİVİLİ KROŞE (3X16+10)	MUTLUSAN	800 ad.	3200	1,81

<b>GALVANİZLİ SAC KROŞELER</b>					
001 048 060001 00 00	NO. 1 TEKLİ GALVANİZ SAC KROŞE 12MM		1500 ad.		2,45
001 048 060002 00 00	NO. 2 TEKLİ GALVANİZ SAC KROŞE 14MM		1000 ad.		2,46
001 048 060003 00 00	NO. 3 TEKLİ GALVANİZ SAC KROŞE 17MM		700 ad.		2,94
001 048 060004 00 00	NO. 4 TEKLİ GALVANİZ SAC KROŞE 20MM		500 ad.		3,07
001 048 060007 00 00	NO. 7 TEKLİ GALVANİZ SAC KROŞE 26MM		350 ad.		3,88
001 048 060008 00 00	NO. 8 TEKLİ GALVANİZ SAC KROŞE 34MM		250 ad.		9,31
001 048 060009 00 00	NO. 9 TEKLİ GALVANİZ SAC KROŞE 43MM		200 ad.		10,59
001 048 060010 00 00	NO. 10 TEKLİ GALVANİZ SAC KROŞE 53MM		150 ad.		11,33
001 048 060011 00 00	NO. 11 TEKLİ GALVANİZ SAC KROŞE 55MM		120 ad.		13,29
001 048 070002 00 00	NO. 2 ÇİFTLİ GALVANİZ SAC KROŞE 13MM		600 ad.		2,83
001 048 070003 00 00	NO. 3 ÇİFTLİ GALVANİZ SAC KROŞE 16MM		500 ad.		3,35
001 048 070004 00 00	NO. 4 ÇİFTLİ GALVANİZ SAC KROŞE 22MM		400 ad.		3,38
001 048 070007 00 00	NO. 7 ÇİFTLİ GALVANİZ SAC KROŞE 25MM		400 ad.		4,14
001 048 070008 00 00	NO. 8 ÇİFTLİ GALVANİZ SAC KROŞE 35MM		300 ad.		9,58
001 048 070009 00 00	NO. 9 ÇİFTLİ GALVANİZ SAC KROŞE 45MM		200 ad.		11,62
001 048 070010 00 00	NO. 10 ÇİFTLİ GALVANİZ SAC KROŞE 50MM		150 ad.		12,36
001 048 070011 00 00	NO. 11 ÇİFTLİ GALVANİZ SAC KROŞE 55MM		100 ad.		13,00



<b>RAY KROŞE VE TANDIR KROŞELER</b>					
035 048 100001	NO. 1 RAY KROŞE (2X1.5-4X2.5)		350 ad.		6,33
035 048 100002	NO. 2 RAY KROŞE (4X4-4X16)		250 ad.		6,78
001 025 010100 00 00	GALVANİZ KROŞE RAYI (1M)		50 ad.		83,22
035 048 110001	NO. 1 TANDIR KROŞE (2X1.5-2X6)		350 ad.		6,33
035 048 110002	NO. 2 TANDIR KROŞE (4X6)		250 ad.		6,33
035 048 110003	NO. 3 TANDIR KROŞE (4X10)		250 ad.		6,33
035 048 110004	NO. 4 TANDIR KROŞE (4X16)		150 ad.		8,13
035 048 110005	NO. 5 TANDIR KROŞE (3X25+16)		150 ad.		8,13



001 053 000001 00 00

001 053 000002 00 00

<b>PLASTİK DÜBELLER</b>					
016 053 000014	BURGULU ALÇIPAN DÜBELİ (YENİ)		100 ad.	10000	0,81
001 053 000001 00 00	ALÇIPAN DÜBEL		100 ad.	15000	0,54
001 053 000002 00 00	KANAL DÜBELİ		1000 ad.	14000	0,43
016 053 000006	6 MM BEYAZ DÜBEL		1000 ad.	35000	0,16
016 053 000007	7 MM BEYAZ DÜBEL		1000 ad.	25000	0,20
016 053 000008	8 MM BEYAZ DÜBEL		1000 ad.	20000	0,25



16 053 000014

<b>DÜBELLİ KROŞELER</b>					
001 048 090002 00 17	3/13 TEKLİ KABLO KROŞESİ		500 ad.	10000	0,70
001 048 090006 00 17	8/28 TEKLİ KABLO KROŞESİ		500 ad.	5000	0,81
001 048 090001 00 00	ÇİFTLİ KABLO KROŞESİ (20'LİK)		100 ad.	8000	0,96
001 048 090002 00 00	ÇİFTLİ KABLO KROŞESİ (25'LİK)		100 ad.	5000	1,06
001 048 090003 00 17	16'LİK BORU KELEPÇESİ		100 ad.	2000	0,83
001 048 090004 00 17	20'LİK BORU KELEPÇESİ		100 ad.	1500	1,49
001 048 090005 00 17	25'LİK BORU KELEPÇESİ		100 ad.	1000	2,08



<b>BORU GEÇME TOPRAKLAMA ÇUBUĞU</b>					
091 025 011610	TOP ÇUBUĞU BORU GEÇMELİ 16 MM 1 MT		10 ad.		570,43
091 025 011615	TOP ÇUBUĞU BORU GEÇMELİ 16 MM 1,5 MT		10 ad.		784,34
091 025 012010	TOP ÇUBUĞU BORU GEÇMELİ 20 MM 1 MT		5 ad.		784,34
091 025 012015	TOP ÇUBUĞU BORU GEÇMELİ 20 MM 1,5 MT		5 ad.		1.188,39



YENİ



YENİ



TELEFON DAĞITIM KUTULARI



Ürün Kodu	Ürün Adı	Kutu Mt./Ad.	Koli Adet	Fiyat (₺)
<b>AKILLI KAPI KİLİDİ</b>				
027 112 000010	AKILLI KAPI KİLİDİ	1 ad.		2.258,93
027 112 000011	KAPI KONTROL SİSTEMİ 500 HAFIZALI TUŞLU	1 ad.		1.310,18
027 112 000012	KAPI KONTROL SİSTEMİ 1000 HAFIZALI KARTLI METAL GÜVDE	1 ad.		2.033,04
<b>KAPI VE MERDİVEN OTOMATIĞI</b>				
027 112 000001	GİZLİ KAPI OTOMATIĞI (DOKUNMATİK)	1 ad.	20	587,32
027 112 000002	GİZLİ KAPI OTOMATIĞI (BASMATİK)	1 ad.	20	587,32
027 112 000007	ELEK. KİLİTLİ (ANAHTARLI) KAPI OTOMATIĞI	1 ad.	12	1.219,82
027 112 000009	ELEKTRİKLİ KİLİTLİ KAPI OTOMATIĞI ( BİLYELİ )	1 ad.	12	1.219,82
027 112 000003	BUTONLU KAPI OTOMATIĞI	1 ad.	30	429,20
028 112 000004	KAPI OTOMATIĞI (NORMAL)	1 ad.	30	415,64
027 112 000004	BAS-AÇ KAPI OTOMATIĞI (TİRAJLI KİLİT İÇİN)	1 ad.		648,21
027 112 000005	MERDİVEN OTOMATIĞI (RAYLI)	1 ad.	30	424,68
027 112 000006	MERDİVEN OTOMATIĞI (NORMAL)	1 ad.	30	424,68
<b>ZİL BUTONU ÇEŞİTLERİ</b>				
037 106 020001	1'Lİ ALÜMİNYUM ZİL BUTONU 1.KALİTE	1 ad.	100	55,34
037 106 020002	2'Lİ ALÜMİNYUM ZİL BUTONU 1.KALİTE	1 ad.	66	110,69
037 106 020003	3'LÜ ALÜMİNYUM ZİL BUTONU 1.KALİTE	1 ad.	56	166,03
037 106 020004	4'LÜ ALÜMİNYUM ZİL BUTONU 1.KALİTE	1 ad.	43	221,38
037 106 020005	5'Lİ ALÜMİNYUM ZİL BUTONU 1.KALİTE	1 ad.	36	276,72
037 106 020006	6'Lİ ALÜMİNYUM ZİL BUTONU 1.KALİTE	1 ad.	32	332,06
037 106 020007	7'Lİ ALÜMİNYUM ZİL BUTONU 1.KALİTE	1 ad.	28	387,41
037 106 020008	8'Lİ ALÜMİNYUM ZİL BUTONU 1.KALİTE	1 ad.	20	442,75
037 106 020009	9'LU ALÜMİNYUM ZİL BUTONU 1.KALİTE	1 ad.	20	498,09
037 106 020010	10'LU ALÜMİNYUM ZİL BUTONU 1.KALİTE	1 ad.	20	553,44
<b>ZİLLER VE ZİL TRAFOLARI</b>				
027 105 010012	ZİL TRAFOSU 12 V	1 ad.	80	230,41
027 105 010015	ZİL TRAFOSU 15 V	1 ad.	40	438,23
028 105 020003	KAMPANA ZİL 220 V	1 ad.	24	1.129,46
028 105 020004	KAMPANA ZİL 12V, 24V, 110V	1 ad.	24	1.649,02
028 105 020000	MUNZAM ZİL ROLESİ	1 ad.	100	790,63
018 105 000006	KANARYA ZİL (TEK SES)	1 ad.	50	112,95
018 105 000007	KANARYA ZİL (ÜÇ SES)	1 ad.	50	144,57
018 105 000001	TELEFON ZİLİ (AYARLI)	1 ad.	50	212,34
018 105 000002	DİNG DONG ZİL ELEKTRONİK (3 SES)	1 ad.	50	158,13
<b>TELEFON DAĞITIM KUTULARI ve AKSESUARLARI</b>				
001 049 001020 00 17	TLF. DĞT. KUTUSU (10 - 20) BOŞ PLS. KLT	2 ad.	60	255,90
001 049 201020 00 17	TLF.DĞT.KUTUSU(10-20)BOŞ PLS.(KİLİTLİ) (A. YAYMAYAN)	2 ad.	60	324,71
001 049 011020 00 17	TLF. DĞT. KUTUSU (10 - 20) BOŞ KİLİTLİ	2 ad.	60	373,62
001 049 211020 00 17	TLF.DĞT.KUTUSU(10-20)BOŞ(KİLİTLİ) (A. YAYMAYAN)	2 ad.	60	447,31
001 049 001050 00 17	TLF. DĞT. KUTUSU(10-50) BOŞ PLS.KİLİT	1 ad.	28	369,80
001 049 201050 00 17	TLF.DĞT.KUTUSU(10-50)BOŞ PLS.(KİLİTLİ) (A. YAYMAYAN)	1 ad.	28	540,69
001 049 011050 00 17	TLF. DĞT. KUTUSU(10-50) KİLİTLİ	1 ad.	28	487,52
001 049 211050 00 17	TLF.DĞT.KUTUSU(10-50)(KİLİTLİ) (A. YAYMAYAN)	1 ad.	28	585,02
001 024 000001 00 00	ÇATI (1 MODÜL İÇİN)	1 ad.	1000	26,24
001 024 000002 00 00	ÇATI (2 MODÜL İÇİN)	1 ad.	500	52,48
001 024 000003 00 00	ÇATI (3 MODÜL İÇİN)	1 ad.	400	78,72
001 024 000004 00 00	ÇATI (4 MODÜL İÇİN)	1 ad.	300	104,96
001 024 000005 00 00	ÇATI (5 MODÜL İÇİN)	1 ad.	200	131,20
001 024 000010 00 00	ÇATI (10 MODÜL İÇİN)	1 ad.	100	262,40
888 049 050001	KESMESİZ MODÜL	10 ad.	250	5,29 \$
888 049 050002	KESMELİ MODÜL	10 ad.	250	6,34 \$
888 049 050003	İRTİBATLAMA ALETİ	1 ad.	50	15,85 \$

	ÜRÜN KODU	888 038 218000
	ÜRÜN ADI	Q218 KABLOSUZ KAPI ZİLİ LEDLİ 100 MT. - 32 MELODİ
	AMB. AD./KOLİ	1 Ad. / 10
	FİYAT	39,14 \$

	ÜRÜN KODU	018 105 114800
	ÜRÜN ADI	A-148 KAPI ZİLİ - 32 MELODİ
	AMB. AD./KOLİ	1 Ad. / 10
	FİYAT	24,97 \$

	ÜRÜN KODU	018 105 158100
	ÜRÜN ADI	X-581 KAPI ZİLİ - 32 MELODİ
	AMB. AD./KOLİ	1 Ad. / 10
	FİYAT	26,13 \$

	ÜRÜN KODU	018 105 162811
	ÜRÜN ADI	WA-628 KAPI ZİLİ - SİYAH 32 MELODİ
	AMB. AD./KOLİ	10/200
	FİYAT	34,73 \$

	ÜRÜN KODU	018 105 162800
	ÜRÜN ADI	WA-628 KAPI ZİLİ BEYAZ 32 MELODİ
	AMB. AD./KOLİ	1 Ad. / 10
	FİYAT	34,73 \$

	ÜRÜN KODU	018 105 163811
	ÜRÜN ADI	WA-638 KAPI ZİLİ - SİYAH 32 MELODİ
	AMB. AD./KOLİ	1 Ad. / 10
	FİYAT	34,73 \$

	ÜRÜN KODU	018 105 163800
	ÜRÜN ADI	WA-638 KAPI ZİLİ BEYAZ 32 MELODİ
	AMB. AD./KOLİ	1 Ad. / 10
	FİYAT	34,73 \$



Kod	Ürün Adı	Kutu Mt./Ad.	Koli Adet	Fiyat (₺)
<b>İKAZ KORNASI</b>				
CE				
026 112 010001	İKAZ KORNASI 220 V	1 ad.	45 ad.	478,89
028 120 000001	İKAZ BUTONU (KARE)	2 ad.	90 ad.	142,31
<b>ALARM KORNA ve YANGIN İHBAR BUTONU</b>				
CE				
010 090 050050	RESELENEBİLİR BUTON	2 ad.		713,82
010 090 050051	RESELENEBİLİR BUTON ( KAPAKLI)	1 ad.		781,59
028 120 010006	ALARM KORNA PLASTİK	1 ad.		722,86
028 120 010005	ALARM KORNA DÖKÜM	1 ad.		835,80
<b>SİRENLER</b>				
102 111 000012	LEDLİ FLAŞÖRLÜ ELEKTRONİK SİREN 12V	1 ad.		337,71
102 111 000024	LEDLİ FLAŞÖRLÜ ELEKTRONİK SİREN 24V	1 ad.		337,71
102 111 000220	LEDLİ FLAŞÖRLÜ ELEKTRONİK SİREN 220V	1 ad.		352,39
102 111 000221	LEDLİ FLAŞÖRLÜ ELEKTRONİK SİREN 220V. (YENİ MODEL)	1 ad.		632,50
888 111 050004	MS190 MİNİ SİREN (105 db)	1 ad.		14,79 \$
026 111 010001	AS. 1 MOTORLU SİREN (PLS. GÖV.)220V,100W (110 db.)	1 ad.		1.626,43
026 111 010002	AS. 2 MOTORLU SİREN (PLS.GÖV.)220V,100W (117 db.)	1 ad.		1.807,14
026 111 010003	AS. 1 MOTORLU SİREN (METAL.GÖV.)220V,100W (115 db.)	CE	1 ad.	2.033,04
026 111 010004	AS. 2 MOTORLU SİREN (METAL.GÖV.)220V,100W (120 db.)	CE	1 ad.	2.462,23
026 111 010005	AS.3 MOTORLU SİREN 220V-280W (130 db.)	CE	1 ad.	13.101,79





## ME-FAN ASPİRATÖR ÇEŞİTLERİ



### 100 mm

Çalışma Akımı Operation Voltage	220-240V / 50-60Hz
Emiş Hacmi Airflow	100m <sup>3</sup> /h
Devir Hız Round Speed	2450 rpm
Ses Voice	43 dB
Güç Power	12W

<b>ÜRÜN KODU</b>	: 001 211 000100 00 00
<b>ÜRÜN ADI</b>	: MUTLUSAN ME-FAN 100 ASPİRATÖR
<b>AMBALAJ ADET / KOLİ</b>	: 1 / 20
<b>FİYAT (₺)</b>	: 324,11 ₺

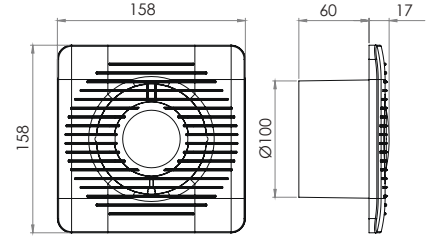

### 120 mm

Çalışma Akımı Operation Voltage	220-240V / 50-60Hz
Emiş Hacmi Airflow	120m <sup>3</sup> /h
Devir Hız Round Speed	1900 rpm
Ses Voice	47 dB
Güç Power	15W

<b>ÜRÜN KODU</b>	: 001 211 000120 00 00
<b>ÜRÜN ADI</b>	: MUTLUSAN ME-FAN 120 ASPİRATÖR
<b>AMBALAJ ADET / KOLİ</b>	: 1 / 20
<b>FİYAT (₺)</b>	: 345,71 ₺

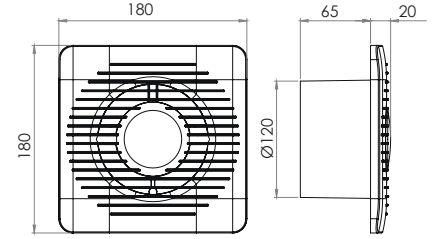

### 150 mm

Çalışma Akımı Operation Voltage	220-240V / 50-60Hz
Emiş Hacmi Airflow	150m <sup>3</sup> /h
Devir Hız Round Speed	1350 rpm
Ses Voice	47 dB
Güç Power	20W

<b>ÜRÜN KODU</b>	: 001 211 000150 00 00
<b>ÜRÜN ADI</b>	: MUTLUSAN ME-FAN 150 ASPİRATÖR
<b>AMBALAJ ADET / KOLİ</b>	: 1 / 12
<b>FİYAT (₺)</b>	: 518,57 ₺

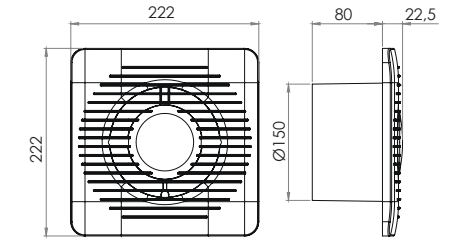

### 200 mm

Çalışma Akımı Operation Voltage	220-240V / 50-60Hz
Emiş Hacmi Airflow	200m <sup>3</sup> /h
Devir Hız Round Speed	1200 rpm
Ses Voice	55 dB
Güç Power	40 W

<b>ÜRÜN KODU</b>	: 001 211 000200 00 00
<b>ÜRÜN ADI</b>	: MUTLUSAN ME-FAN 200 ASPİRATÖR
<b>AMBALAJ ADET / KOLİ</b>	: 1 / 6
<b>FİYAT (₺)</b>	: 993,93 ₺

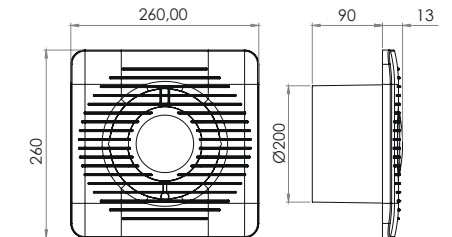

## MUTLUSAN ASPİRATÖR ÇEŞİTLERİ



### 100 mm

Çalışma Akımı Operation Voltage	220-240V / 50-60Hz
Emiş Hacmi Airflow	100m <sup>3</sup> /h
Devir Hız Round Speed	2450 rpm
Ses Voice	43 dB
Güç Power	12W

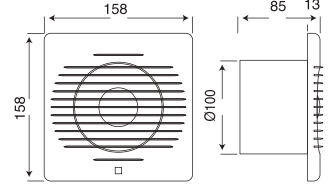

<b>ÜRÜN KODU</b>	: 001 111 000100 00 00
<b>ÜRÜN ADI</b>	: MUTLUSAN 100 ASPİRATÖR
<b>AMBALAJ ADET / KOLİ</b>	: 1 / 20
<b>FİYAT (₺)</b>	: 383,40 ₺



### 120 mm

Çalışma Akımı Operation Voltage	220-240V / 50-60Hz
Emiş Hacmi Airflow	120m <sup>3</sup> /h
Devir Hız Round Speed	1900 rpm
Ses Voice	47 dB
Güç Power	15W

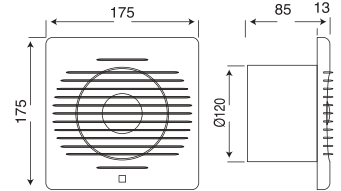

<b>ÜRÜN KODU</b>	: 001 111 000120 00 00
<b>ÜRÜN ADI</b>	: MUTLUSAN 120 ASPİRATÖR
<b>AMBALAJ ADET / KOLİ</b>	: 1 / 20
<b>FİYAT (₺)</b>	: 398,95 ₺



### 150 mm

Çalışma Akımı Operation Voltage	220-240V / 50-60Hz
Emiş Hacmi Airflow	150m <sup>3</sup> /h
Devir Hız Round Speed	1350 rpm
Ses Voice	47 dB
Güç Power	20W

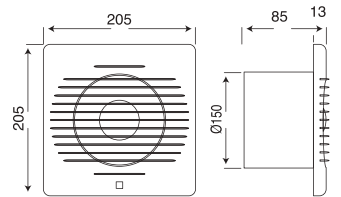

<b>ÜRÜN KODU</b>	: 001 111 000150 00 00
<b>ÜRÜN ADI</b>	: MUTLUSAN 150 ASPİRATÖR
<b>AMBALAJ ADET / KOLİ</b>	: 1 / 16
<b>FİYAT (₺)</b>	: 567,47 ₺



### 200 mm

Çalışma Akımı Operation Voltage	220-240V / 50-60Hz
Emiş Hacmi Airflow	200m <sup>3</sup> /h
Devir Hız Round Speed	1000 rpm
Ses Voice	47 dB
Güç Power	40W

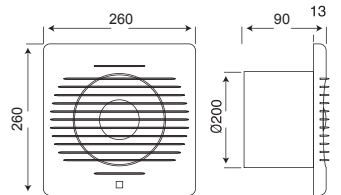

<b>ÜRÜN KODU</b>	: 001 111 000200 00 00
<b>ÜRÜN ADI</b>	: MUTLUSAN 200 ASPİRATÖR
<b>AMBALAJ ADET / KOLİ</b>	: 1 / 6
<b>FİYAT (₺)</b>	: 1.079,38 ₺

## MUTLUSAN ASPIRATÖR ÇEŞİTLERİ

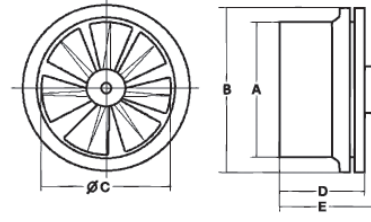

Ürün Kodu	Ürün Adı	Güç Watt	Hız Devir/Dk	Debi m <sup>3</sup> /h	A	B	C	D	E	Adet	Fiyat (\$)
080 088 160160	MB160MM BACA ASPIRATÖR	40	1300	400	160	210	154	85	110	1	65,24
080 088 160200	MB200MM BACA ASPIRATÖR	40	1300	650	200	265	194	85	110	1	73,82
080 088 160250	MB250MM BACA ASPIRATÖR	50	1300	800	240	305	224	110	125	1	85,84
080 088 160300	MB300MM BACA ASPIRATÖR	60	1300	1000	295	365	284	110	125	1	97,86

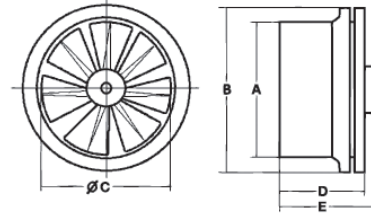

Ürün Kodu	Ürün Adı	Güç Watt	Hız Devir/Dk	Debi m <sup>3</sup> /h	A	B	C	D	E	Adet	Fiyat (\$)
080 088 200160	MK160MM KAPAKLI ASPIRATÖR	40	1300	400	160	210	154	85	110	1	72,11
080 088 200200	MK200MM KAPAKLI ASPIRATÖR	40	1300	650	200	265	194	85	110	1	82,41
080 088 200250	MK250MM KAPAKLI ASPIRATÖR	50	1300	800	240	305	224	110	125	1	99,57
080 088 200300	MK300MM KAPAKLI ASPIRATÖR	60	1300	1000	295	365	284	110	125	1	111,59

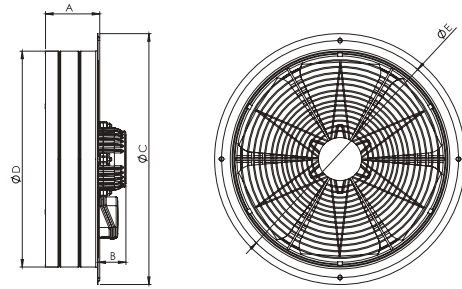

Ürün Kodu	Ürün Adı	Güç Watt	Hız Devir/Dk	Debi m <sup>3</sup> /h	A	B	C	D	E	Adet	Fiyat (\$)
080 088 002250	MSM250-2K MONOFAZE SANAYİ TİPİ ASPIRATÖR	180	2800	2400	114	61	304	251	277	1	180,26
080 088 000250	MSM250 MONOFAZE SANAYİ TİPİ ASPIRATÖR	125	1400	1200	114	61	304	251	277	1	180,26
080 088 000300	MSM300 MONOFAZE SANAYİ TİPİ ASPIRATÖR	125	1400	2200	114	61	390	325	360	1	214,60
080 088 000350	MSM350 MONOFAZE SANAYİ TİPİ ASPIRATÖR	155	1400	3200	114	61	435	374	405	1	228,33
080 088 000400	MSM400 MONOFAZE SANAYİ TİPİ ASPIRATÖR	180	1400	4100	114	61	485	427	455	1	240,35
080 088 000450	MSM450 MONOFAZE SANAYİ TİPİ ASPIRATÖR	220	1400	4800	114	61	546	470	516	1	269,54
080 088 000500	MSM500 MONOFAZE SANAYİ TİPİ ASPIRATÖR	250	1400	5200	125	61	590	518	560	1	291,85
080 088 000550	MSM550 MONOFAZE SANAYİ TİPİ ASPIRATÖR	280	1400	6000	130	160	624	560	595	1	402,09
080 088 000600	MSM600 MONOFAZE SANAYİ TİPİ ASPIRATÖR	290	1400	7500	130	160	674	610	645	1	343,36

Ürün Kodu	Ürün Adı	Güç Watt	Hız Devir/Dk	Debi m <sup>3</sup> /h	A	B	C	D	E	Adet	Fiyat (\$)
080 088 102250	MST250-2K TRİFAZE SANAYİ TİPİ ASPIRATÖR	180	2800	2400	114	61	304	251	277	1	180,26
080 088 100250	MST250 TRİFAZE SANAYİ TİPİ ASPIRATÖR	125	1400	1200	114	61	304	251	277	1	180,26
080 088 100300	MST300 TRİFAZE SANAYİ TİPİ ASPIRATÖR	125	1400	2200	114	61	390	325	360	1	214,60
080 088 100350	MST350 TRİFAZE SANAYİ TİPİ ASPIRATÖR	155	1400	3200	114	61	435	374	405	1	228,33
080 088 100400	MST400 TRİFAZE SANAYİ TİPİ ASPIRATÖR	180	1400	4100	114	61	485	427	455	1	240,35
080 088 100450	MST450 TRİFAZE SANAYİ TİPİ ASPIRATÖR	220	1400	4800	114	61	546	470	516	1	269,54
080 088 100500	MST500 TRİFAZE SANAYİ TİPİ ASPIRATÖR	250	1400	5200	125	61	590	518	560	1	291,85
080 088 100600	MST600 TRİFAZE SANAYİ TİPİ ASPIRATÖR	290	1400	7500	130	160	674	610	645	1	343,36

## LED ARMATÜR ÇEŞİTLERİ



RENK	BEYAZ	SİYAH
ÜRÜN KODU	016 038 701500	016 038 701511
ÜRÜN ADI	LED GLOP ARMATÜR IP20	
LÜMEN/WATT	2000Lm/20W	
KELVIN	6400K	
AMB. AD./KOLİ	24	
FİYAT (₺)	307,21	



ÜRÜN KODU	016 038 701522
ÜRÜN ADI	LED GLOP ARMATÜR KROM - IP20
LÜMEN/WATT	2000Lm/20W
KELVIN	6400K
AMB. AD./KOLİ	24
FİYAT (₺)	356,91



IP65

ÜRÜN KODU	016 038 701200
ÜRÜN ADI	LEDLIGHT-2 LEDLİ ARMATÜR - BEYAZ
LÜMEN/WATT	2000Lm/20W
KELVIN	6400K
AMB. AD./KOLİ	20
FİYAT (₺)	308,75



IP65

ÜRÜN KODU	016 038 701211
ÜRÜN ADI	LEDLIGHT-2 LEDLİ ARMATÜR - SİYAH
LÜMEN/WATT	2000Lm/20W
KELVIN	6400K
AMB. AD./KOLİ	20
FİYAT (₺)	308,75

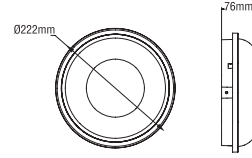
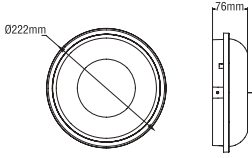

IP65

ÜRÜN KODU	016 038 701300
ÜRÜN ADI	LEDLIGHT-3 LEDLİ ARMATÜR - BEYAZ
LÜMEN/WATT	1500Lm/15W
KELVIN	6400K
AMB. AD./KOLİ	30
FİYAT (₺)	228,24



IP65

ÜRÜN KODU	016 038 701311
ÜRÜN ADI	LEDLIGHT-3 LEDLİ ARMATÜR - SİYAH
LÜMEN/WATT	1500Lm/15W
KELVIN	6400K
AMB. AD./KOLİ	30
FİYAT (₺)	228,24

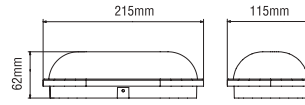
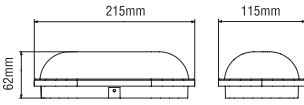

IP65

ÜRÜN KODU	016 038 701400
ÜRÜN ADI	LEDLIGHT-4 LEDLİ ARMATÜR - BEYAZ
LÜMEN/WATT	2000Lm/20W
KELVIN	6400K
AMB. AD./KOLİ	20
FİYAT (₺)	308,75



IP65

ÜRÜN KODU	016 038 701411
ÜRÜN ADI	LEDLIGHT-4 LEDLİ ARMATÜR - SİYAH
LÜMEN/WATT	2000Lm/20W
KELVIN	6400K
AMB. AD./KOLİ	20
FİYAT (₺)	308,75

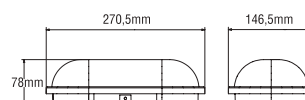
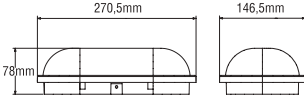

IP65

ÜRÜN KODU	016 038 701100
ÜRÜN ADI	LEDLIGHT-1 LEDLİ ARMATÜR - BEYAZ
LÜMEN/WATT	1500Lm/15W
KELVIN	6400K
AMB. AD./KOLİ	30
FİYAT (₺)	228,24



IP65

ÜRÜN KODU	016 038 701111
ÜRÜN ADI	LEDLIGHT-1 LEDLİ ARMATÜR - SİYAH
LÜMEN/WATT	1500Lm/15W
KELVIN	6400K
AMB. AD./KOLİ	30
FİYAT (₺)	228,24

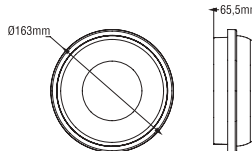
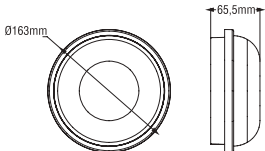

## ARMATÜR ÇEŞİTLERİ

	ÜRÜN KODU	001 038 250021 00 00
	ÜRÜN ADI	360° SENSÖRLÜ TAVAN ARM. ACİL KİTLİ (2x25W) (PİL DAHİL)
	AMB. AD./KOLİ	1/12
	FİYAT (₺)	790,63

	ÜRÜN KODU	001 038 250022 00 00
	ÜRÜN ADI	360° SENSÖRLÜ TAVAN ARMATÜRÜ (2x25W)
	AMB. AD./KOLİ	1/12
	FİYAT (₺)	406,61

	ÜRÜN KODU	001 038 250052 00 00
	ÜRÜN ADI	360° SENSÖRLÜ TAVAN ARM. (2x25W) (TSE)
	AMB. AD./KOLİ	1/12
	FİYAT (₺)	609,91

	ÜRÜN KODU	016 038 250085
	ÜRÜN ADI	ÇINAR DUVAR APLİK PLS, SOFT
	AMB. AD./KOLİ	1/24
	FİYAT (₺)	354,36



Max: 28W



Max: 28W

	ÜRÜN KODU	078 039 500100
	ÜRÜN ADI	SENSÖRLÜ DUVAR APLİK E-27 DUYLU
	AMB. AD./KOLİ	1/20
	FİYAT (₺)	406,61

	ÜRÜN KODU	078 039 100006
	ÜRÜN ADI	ÇİFT DUYLU TAVAN ARMATÜR
	AMB. AD./KOLİ	2/32
	FİYAT (₺)	203,30



Max: 28W

	ÜRÜN KODU	016 038 250086
	ÜRÜN ADI	İNCİ TAVAN ARMATÜR - BEYAZ
	AMB. AD./KOLİ	4/32
	FİYAT (₺)	144,57

	ÜRÜN KODU	016 038 250087
	ÜRÜN ADI	İNCİ TAVAN ARMATÜR - CEVİZ
	AMB. AD./KOLİ	4/32
	FİYAT (₺)	167,16

## ARMATÜR ÇEŞİTLERİ

	ÜRÜN KODU	016 038 250090
	ÜRÜN ADI	YILDIZ TAVAN ARMATÜRÜ
	AMB. AD./KOLİ	8/64
	FİYAT (₺)	85,35

	ÜRÜN KODU	016 038 250088
	ÜRÜN ADI	İNCİ APLİK - DUVAR ARMATÜR - BEYAZ
	AMB. AD./KOLİ	4/64
	FİYAT (₺)	90,75

	ÜRÜN KODU	016 038 250089
	ÜRÜN ADI	İNCİ APLİK - DUVAR ARMATÜR - CEVİZ
	AMB. AD./KOLİ	4/64
	FİYAT (₺)	121,00

	ÜRÜN KODU	024 109 010005
	ÜRÜN ADI	YAĞMUR DUY (PLASTİK YANMAZ) E27
	AMB. AD./KOLİ	50
	FİYAT (₺)	24,85

	ÜRÜN KODU	001 038 250017 00 00
	ÜRÜN ADI	BÜYÜK PAPATYA HAZIR ASKI TİJ TAKIMI
	AMB. AD./KOLİ	10/80
	FİYAT (₺)	53,41

	ÜRÜN KODU	001 038 250016 00 00
	ÜRÜN ADI	PAPATYA HAZIR ASKI TİJ TAKIMI
	AMB. AD./KOLİ	25/275
	FİYAT (₺)	36,01

	ÜRÜN KODU	001 038 250018 00 00
	ÜRÜN ADI	HAZIR ASKI TİJ TAKIMI
	AMB. AD./KOLİ	25/300
	FİYAT (₺)	34,50

	ÜRÜN KODU	078 039 100005
	ÜRÜN ADI	NERGİS APLİK
	AMB. AD./KOLİ	8/64
	FİYAT (₺)	90,36

## NEMLİYER ARMATÜR ÇEŞİTLERİ



	ÜRÜN KODU	016 038 411110
	ÜRÜN ADI	AQUA KAFESLİ APLİK BEYAZ - IP65
	AMB. AD./KOLİ	1/20
	FİYAT (₺)	159,63

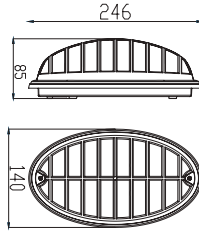

	ÜRÜN KODU	016 038 411120
	ÜRÜN ADI	AQUA KAFESLİ APLİK SİYAH - IP65
	AMB. AD./KOLİ	1/20
	FİYAT (₺)	159,63

	ÜRÜN KODU	016 038 411300
	ÜRÜN ADI	OPAK KAFESLİ ARM. BEYAZ - IP54
	AMB. AD./KOLİ	1/24
	FİYAT (₺)	194,93

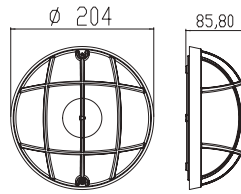

	ÜRÜN KODU	016 038 411311
	ÜRÜN ADI	OPAK KAFESLİ ARM. SİYAH - IP54
	AMB. AD./KOLİ	1/24
	FİYAT (₺)	194,93

	ÜRÜN KODU	016 038 410600
	ÜRÜN ADI	ELİPS OPAL ARM. BEYAZ - IP65
	AMB. AD./KOLİ	1/10
	FİYAT (₺)	340,92

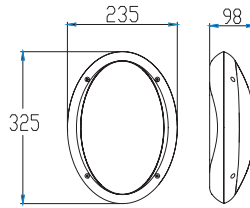

	ÜRÜN KODU	016 038 410611
	ÜRÜN ADI	ELİPS OPAL ARM. SİYAH - IP65
	AMB. AD./KOLİ	1/10
	FİYAT (₺)	340,92

	ÜRÜN KODU	016 038 410500
	ÜRÜN ADI	OPAL ARMATÜR BEYAZ - IP65
	AMB. AD./KOLİ	1/10
	FİYAT (₺)	332,51

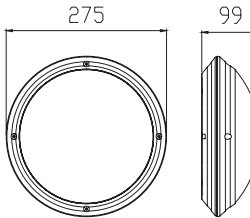

	ÜRÜN KODU	016 038 410511
	ÜRÜN ADI	OPAL ARMATÜR SİYAH - IP65
	AMB. AD./KOLİ	1/10
	FİYAT (₺)	332,51

	ÜRÜN KODU	016 038 410800
	ÜRÜN ADI	OPAK ARMATÜR BEYAZ - IP65
	AMB. AD./KOLİ	1/16
	FİYAT (₺)	234,92

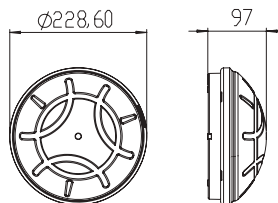

	ÜRÜN KODU	016 038 410811
	ÜRÜN ADI	OPAK ARMATÜR SİYAH - IP65
	AMB. AD./KOLİ	1/16
	FİYAT (₺)	234,92

## NEMLİYER ARMATÜR ÇEŞİTLERİ

	ÜRÜN KODU	016 038 700100
	ÜRÜN ADI	DOLUNAY OPAK ARM. BEYAZ - IP54
	AMB. AD./KOLİ	1/16
	FİYAT (₺)	228,57

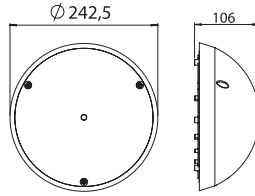

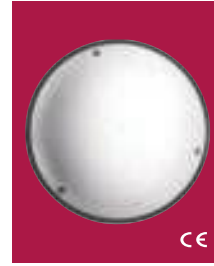
	ÜRÜN KODU	016 038 700111
	ÜRÜN ADI	DOLUNAY OPAK ARM. SİYAH - IP54
	AMB. AD./KOLİ	1/16
	FİYAT (₺)	228,57

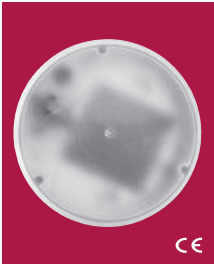
	ÜRÜN KODU	016 038 700200
	ÜRÜN ADI	DOLUNAY ŞEFFAF ARM. BEYAZ - IP54
	AMB. AD./KOLİ	1/16
	FİYAT (₺)	228,53

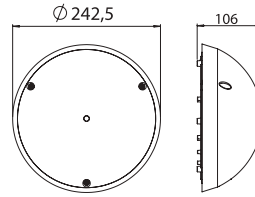

	ÜRÜN KODU	016 038 700211
	ÜRÜN ADI	DOLUNAY ŞEFFAF ARM. SİYAH - IP54
	AMB. AD./KOLİ	1/16
	FİYAT (₺)	228,53

	ÜRÜN KODU	016 038 700300
	ÜRÜN ADI	DOLUNAY OPAK APLİK BEYAZ - IP54
	AMB. AD./KOLİ	1/20
	FİYAT (₺)	212,49

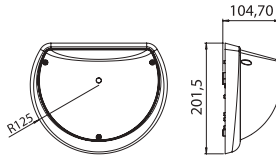

	ÜRÜN KODU	016 038 700311
	ÜRÜN ADI	DOLUNAY OPAK APLİK SİYAH - IP54
	AMB. AD./KOLİ	1/20
	FİYAT (₺)	212,49

	ÜRÜN KODU	016 038 700400
	ÜRÜN ADI	DOLUNAY ŞEFFAF APLİK BEYAZ - IP54
	AMB. AD./KOLİ	1/20
	FİYAT (₺)	212,49

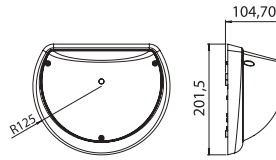

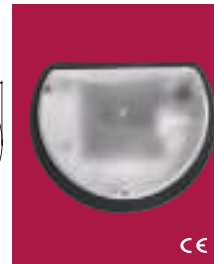
	ÜRÜN KODU	016 038 700411
	ÜRÜN ADI	DOLUNAY ŞEFFAF APLİK SİYAH - IP54
	AMB. AD./KOLİ	1/20
	FİYAT (₺)	212,49

	ÜRÜN KODU	001 038 150101 00 00
	ÜRÜN ADI	BEGONYA NEMLİYER TAVAN ARMATÜRÜ KLASİK - IP54
	AMB. AD./KOLİ	12
	FİYAT (₺)	316,38

	ÜRÜN KODU	001 038 130101 00 00
	ÜRÜN ADI	BEGONYA NEMLİYER TAVAN ARMATÜRÜ DİKEY - IP54
	AMB. AD./KOLİ	12
	FİYAT (₺)	316,38

	ÜRÜN KODU	001 038 140101 00 00
	ÜRÜN ADI	BEGONYA NEMLİYER TAVAN ARMATÜRÜ YATAY - IP54
	AMB. AD./KOLİ	12
	FİYAT (₺)	316,38



## BAHÇE ARMATÜRLERİ



CE IP43



Ürün Kodu	Ürün Adı	Ambalaj Adet/Koli	Fiyat (₺)
016 038 010116	FLORA BAHÇE ARMATÜRÜ - SIYAH	1/12	264,39
016 038 020116	FLORA BAHÇE ARMATÜRÜ - BEYAZ	1/12	264,39



Ürün Kodu	Ürün Adı	Ambalaj Adet/Koli	Fiyat (₺)
016 038 010117	FLORA BAHÇE ARMATÜRÜ APLİK - SIYAH	1/12	265,77
016 038 020117	FLORA BAHÇE ARMATÜRÜ APLİK - BEYAZ	1/12	265,77



Ürün Kodu	Ürün Adı	Ambalaj Adet/Koli	Fiyat (₺)
016 038 412011	FLORA BAHÇE ARMATÜRÜ TAVAN TİPİ - SIYAH	1/12	265,77
016 038 412000	FLORA BAHÇE ARMATÜRÜ TAVAN TİPİ - BEYAZ	1/12	265,77



Ürün Kodu	Ürün Adı	Ambalaj Adet/Koli	Fiyat (₺)
016 038 412111	FLORA BAHÇE ARMATÜRÜ YARIM APLİK - SIYAH	1/20	237,87
016 038 412100	FLORA BAHÇE ARMATÜRÜ YARIM APLİK - SIYAH	1/20	237,87

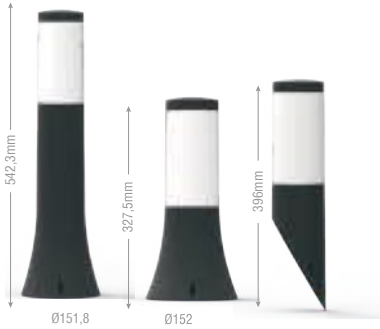

CE IP44

Ürün Kodu	Ürün Adı	Ölçü	Ambalaj Adet/Koli	Fiyat (₺)
016 038 010120	GARDEN UZUN YER AYDINLATMA - SIYAH	542,3mm x Ø151,8	1/8	250,55
016 038 010118	GARDEN YER AYDINLATMA - SIYAH	327,5mm x Ø152	1/12	222,47
016 038 010122	GARDEN DUVAR AYDINLATMA - SIYAH	396mm	1/20	203,81

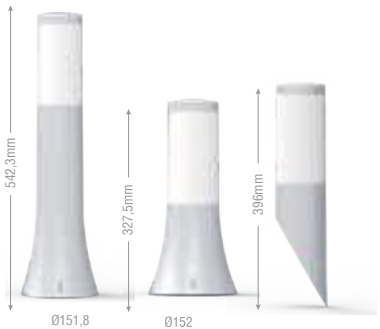

Ürün Kodu	Ürün Adı	Ölçü	Ambalaj Adet/Koli	Fiyat (₺)
016 038 010121	GARDEN UZUN YER AYDINLATMA - GRİ	542,3mm x Ø151,8	1/8	250,55
016 038 010119	GARDEN YER AYDINLATMA - GRİ	327,5mm x Ø152	1/12	222,47
016 038 010123	GARDEN DUVAR AYDINLATMA - GRİ	396mm	1/20	203,81

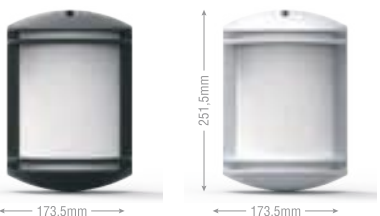

Ürün Kodu	Ürün Adı	Ambalaj Adet/Koli	Fiyat (₺)
016 038 010124	GARDEN APLİK - SIYAH	1/16	267,24
016 038 010125	GARDEN APLİK - GRİ	1/16	267,24

## EXIT - ACİL AYDINLATMA ARMATÜRLERİ (LEDLİ) - IP20 CE



102 038 0008XX - CEXA

FİYAT : 496,96 ₺

\*GÖVDE : ABS  
\*CAM : Polistren (PS) isteğe bağlı Akrilik(PMMA) veya Policarbon(PC)  
\*BASKI : Akrilik Işık geçirgen Translucent Folyo  
\*ÇALIŞMA : Acil de ve Şebeke de sürekli çalışma  
\*PİL : 3.6V 80mAH NiMH (NikelMethalhürid)  
\*ŞARJ SÜRESİ : 14-20 Saat  
\*DEŞARJ SÜRESİ : 180 Dk  
\*KORUMA SINIFI : IP20  
\*LED : 4.8mm 6000K Beyaz Mantar Led  
veya 2835 6400K EDİSON OPTO SMD Led  
TÜKETİM : 2 Watt

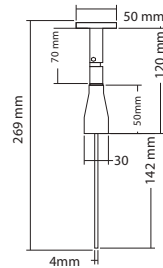
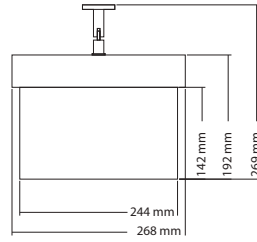

01	02	03	04	05	06	07	08
09	10	11	12	13	14		
15	16	17	18	19	20		
21	22	23	24	25	26		
27	28	29	30	31	32		
33	34	35	36				
37	38	39	40	41	42	43	
44	45	46	47	48	49	50	
44	45	46	47	48	49	50	51
52	53	54	55	56	57	58	59
60	61	62	63	64	65		

\*Sipariş Verdiğiniz Ürünün Sembol Kodunu Yazmayı Unutmayınız.

\*Ürün Kodunun Son 2 hanesi olan XX Rakamları Ürünün Sembol Kodunu belirtmektedir.



# PANO ve ENDÜSTRİYEL ÜRÜN GRUBU

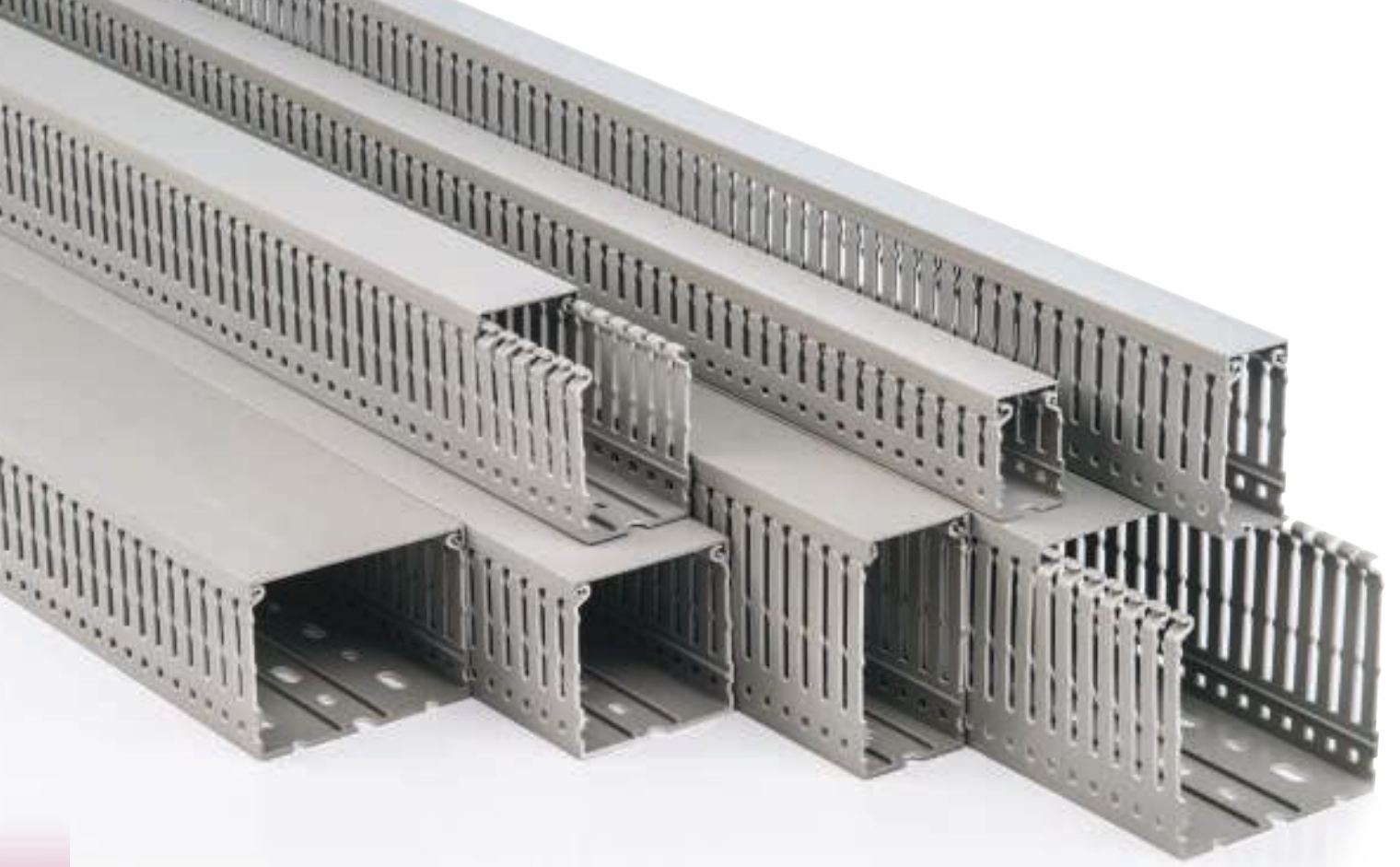

**Promex**

**PANO TIPI  
DELİKLİ  
KABLO KANALLARI**

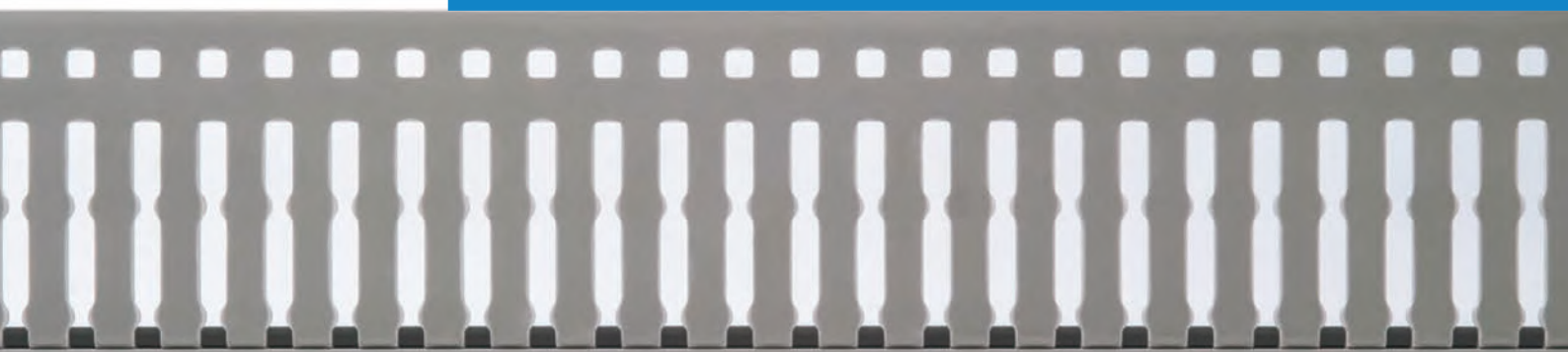



Kanal tırnakları tabanın üst noktasından, herhangi bir el aletine gereksinim duymadan 90 derecelik bükülme sonucu kolayca kırılabilir.

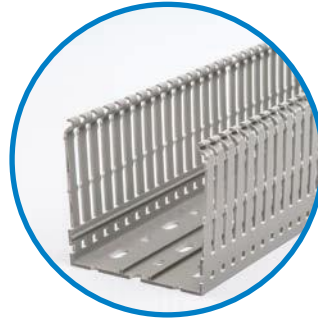

Özel tırnak tasarım yapısı ile kablolarınızı sıkıştırabilirsiniz. Kanal içindeki kabloların, kablo bağı ile bağlanmasına imkan veren delikleri sayesinde daha düzenli ve hızlı kablolama imkanına sahip olursunuz.



Kanal yan duvarı, kolay kırılma çizgileri sayesinde tabana sıfır olarak çıkarılabilir.

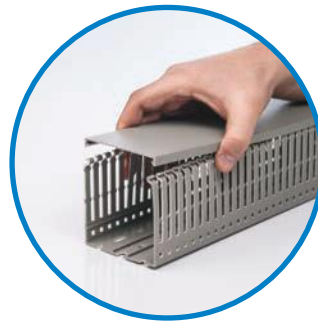

Özel kapak tasarımı, kanalın hangi konumda monte edildiğine bakılmaksızın kapağı kolayca monte etmemizi ve sökmemizi sağlar. Yoğun kablolamalarda bile kapağın kendinden çıkmasını engeller.

UL94-V0 alev iletmez özelliğe sahip PVC hammaddeden imal

Slot aralığı 4/6/4 + 5/8/5 mm genişliğinde

Taban montaj delikleri DIN 43659 standartına uygun

Standart kanal boyları 2mt

EN 50085-2-3 standartlarına uygun

Her türlü sevkiyat ve depolama koşullarına dayanıklı özel karton ambalaj

Standart renk RAL7030 Gri, istek üzerine diğer renkler üretilebilir

CE, RoHS sertifikalı

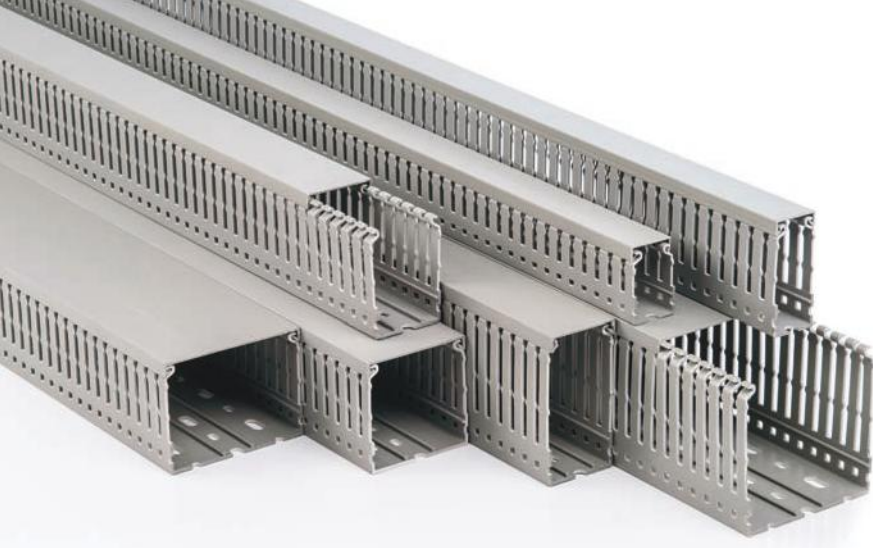

# Promex

## PANO TİPİ DELİKLİ KABLO KANALLARI



Ürün Kodu	Ölçü (mm)	Ürün Adı	Slot Aralığı (mm)	Ambalaj/Mt.	Fiyat (₺)
<b>PROMEX DELİKLİ KABLO KANALI</b>					
001 105 025030 20 17	25x30	PROMEX DELİKLİ KABLO KANALI	4/6/4 mm	2m. 120	64,33
001 105 025040 20 17	25x40	PROMEX DELİKLİ KABLO KANALI	4/6/4 mm	2m. 128	69,36
001 105 025060 20 17	25x60	PROMEX DELİKLİ KABLO KANALI	4/6/4 mm	2m. 96	91,97
001 105 025080 20 17	25x80	PROMEX DELİKLİ KABLO KANALI	4/6/4 mm	2m. 64	116,92
001 105 040040 20 17	40x40	PROMEX DELİKLİ KABLO KANALI	4/6/4 mm	2m. 70	89,40
001 105 040060 20 17	40x60	PROMEX DELİKLİ KABLO KANALI	4/6/4 mm	2m. 60	106,25
001 105 040080 20 17	40x80	PROMEX DELİKLİ KABLO KANALI	4/6/4 mm	2m. 40	141,47
001 105 040100 20 17	40x100	PROMEX DELİKLİ KABLO KANALI	5/8/5 mm	2m. 40	172,50
001 105 060040 20 17	60x40	PROMEX DELİKLİ KABLO KANALI	4/6/4 mm	2m. 50	123,83
001 105 060060 20 17	60x60	PROMEX DELİKLİ KABLO KANALI	4/6/4 mm	2m. 48	147,98
001 105 060080 20 17	60x80	PROMEX DELİKLİ KABLO KANALI	4/6/4 mm	2m. 32	184,64
001 105 060100 20 17	60x100	PROMEX DELİKLİ KABLO KANALI	5/8/5 mm	2m. 32	199,08
001 105 080060 20 17	80x60	PROMEX DELİKLİ KABLO KANALI	4/6/4 mm	2m. 25	177,28
001 105 080080 20 17	80x80	PROMEX DELİKLİ KABLO KANALI	4/6/4 mm	2m. 24	221,04
001 105 080100 20 17	80x100	PROMEX DELİKLİ KABLO KANALI	5/8/5 mm	2m. 24	328,09
001 105 100060 20 17	100x60	PROMEX DELİKLİ KABLO KANALI	4/6/4 mm	2m. 20	245,36
001 105 100080 20 17	100x80	PROMEX DELİKLİ KABLO KANALI	4/6/4 mm	2m. 20	248,66
001 105 100100 20 17	100x100	PROMEX DELİKLİ KABLO KANALI	5/8/5 mm	2m. 16	385,65
001 105 120060 20 17	120x60	PROMEX DELİKLİ KABLO KANALI	4/6/4 mm	2m. 20	252,36
001 105 120080 20 17	120x80	PROMEX DELİKLİ KABLO KANALI	4/6/4 mm	2m. 16	332,57

### PROMEX FLARET SERİSİ DELİKLİ KABLO KANALI - HALOGEN FREE



001 065 025040 20 17	25x40	PROMEX H.F. DELİKLİ KABLO KANALI	4/6/4 mm	2m. 128	270,50
001 065 040040 20 17	40x40	PROMEX H.F. DELİKLİ KABLO KANALI	4/6/4 mm	2m. 70	348,64
001 065 040060 20 17	40x60	PROMEX H.F. DELİKLİ KABLO KANALI	4/6/4 mm	2m. 60	435,62
001 065 060060 20 17	60x60	PROMEX H.F. DELİKLİ KABLO KANALI	4/6/4 mm	2m. 48	562,32

### PROMEX KABLO KANALI KAPAKLARI

001 016 100025 20 17	25'LİK	PROMEX KAPAK		50	19,07
001 016 100040 20 17	40'LİK	PROMEX KAPAK		50	23,95
001 016 100060 20 17	60'LİK	PROMEX KAPAK		50	36,73
001 016 100080 20 17	80'LİK	PROMEX KAPAK		50	45,80
001 016 100100 20 17	100'LÜK	PROMEX KAPAK		50	53,48
001 016 100120 20 17	120'LİK	PROMEX KAPAK		50	66,41

XX : 10 1mt. delikli kablo kanalı için.  
XX : 20 2mt. delikli kablo kanalı için.

Ürün Kodu	Ölçü (mm)	Ürün Adı	Ambalaj Koli -1 mt	Ambalaj Koli - 2 mt	Fiyat (₺)
-----------	-----------	----------	--------------------	---------------------	-----------

### PANO İÇİN MEKS DELİKLİ KABLO KANALLAR (GRİ)

001 005 025025 XX 17	25x25	MEKS DELİKLİ KABLO KANALI(GRİ)	1mt. 64	2mt. 120	41,34
001 005 025040 XX 17	25x40	MEKS DELİKLİ KABLO KANALI(GRİ)	1mt. 40	2mt. 80	52,97
001 005 025060 XX 17	25x60	MEKS DELİKLİ KABLO KANALI(GRİ)	1mt. 36	2mt. 80	85,54
001 005 040040 XX 17	40x40	MEKS DELİKLİ KABLO KANALI(GRİ)	1mt. 25	2mt. 50	68,09
001 005 040060 XX 17	40x60	MEKS DELİKLİ KABLO KANALI(GRİ)	1mt. 24	2mt. 48	90,86
001 005 060040 XX 17	60x40	MEKS DELİKLİ KABLO KANALI(GRİ)	1mt. 24	2mt. 48	92,98
001 005 060060 XX 17	60x60	MEKS DELİKLİ KABLO KANALI(GRİ)	1mt. 16	2mt. 32	116,97
001 005 060080 XX 17	60x80	MEKS DELİKLİ KABLO KANALI(GRİ)	1mt. 12	2mt. 24	144,06
001 005 060100 XX 17	60x100	MEKS DELİKLİ KABLO KANALI(GRİ)	1mt. 8	2mt. 16	160,21
001 005 040080 XX 17	40x80	MEKS DELİKLİ KABLO KANALI(GRİ)	1mt. 18	2mt. 36	127,56
001 005 080060 XX 17	80x60	MEKS DELİKLİ KABLO KANALI(GRİ)	1mt. 12	2mt. 24	159,91
001 005 100060 XX 17	100x60	MEKS DELİKLİ KABLO KANALI(GRİ)	1mt. 8	2mt. 16	204,81
001 005 100100 XX 17	100x100	MEKS DELİKLİ KABLO KANALI(GRİ)	1mt. 4	2mt. 8	270,77

### PANO İÇİN MEKS DELİKLİ KABLO KANALLAR (MAVİ)

001 005 025025 XX 13	25x25	MEKS DELİKLİ KABLO KANALI(MAVİ)	1mt. 64	2mt. 120	43,14
001 005 025040 XX 13	25x40	MEKS DELİKLİ KABLO KANALI(MAVİ)	1mt. 40	2mt. 80	55,32
001 005 025060 XX 13	25x60	MEKS DELİKLİ KABLO KANALI(MAVİ)	1mt. 36	2mt. 80	91,70
001 005 040040 XX 13	40x40	MEKS DELİKLİ KABLO KANALI(MAVİ)	1mt. 25	2mt. 50	71,11
001 005 040060 XX 13	40x60	MEKS DELİKLİ KABLO KANALI(MAVİ)	1mt. 24	2mt. 48	95,97
001 005 060040 XX 13	60x40	MEKS DELİKLİ KABLO KANALI(MAVİ)	1mt. 24	2mt. 48	97,45
001 005 060060 XX 13	60x60	MEKS DELİKLİ KABLO KANALI(MAVİ)	1mt. 16	2mt. 32	125,18
001 005 060080 XX 13	60x80	MEKS DELİKLİ KABLO KANALI(MAVİ)	1mt. 12	2mt. 24	156,39
001 005 060100 XX 13	60x100	MEKS DELİKLİ KABLO KANALI(MAVİ)	1mt. 8	2mt. 16	168,91
001 005 040080 XX 13	40x80	MEKS DELİKLİ KABLO KANALI(MAVİ)	1mt. 18	2mt. 36	147,07
001 005 080060 XX 13	80x60	MEKS DELİKLİ KABLO KANALI(MAVİ)	1mt. 12	2mt. 24	181,08
001 005 100060 XX 13	100x60	MEKS DELİKLİ KABLO KANALI(MAVİ)	1mt. 8	2mt. 16	228,66
001 005 100100 XX 13	100x100	MEKS DELİKLİ KABLO KANALI(MAVİ)	1mt. 4	2mt. 8	313,31

### YAPIŞKAN BANTLI MEKS DELİKLİ KABLO KANALLAR (GRİ)

001 008 025025 XX 17	25x25	MEKS DELİKLİ KABLO KANALI(YPŞK. BANTLI)(GRİ)	1mt. 64	2mt. 120	45,04
001 008 025040 XX 17	25x40	MEKS DELİKLİ KABLO KANALI(YPŞK. BANTLI)(GRİ)	1mt. 40	2mt. 80	56,00
001 008 025060 XX 17	25x60	MEKS DELİKLİ KABLO KANALI(YPŞK. BANTLI)(GRİ)	1mt. 36	2mt. 80	91,36
001 008 040040 XX 17	40x40	MEKS DELİKLİ KABLO KANALI(YPŞK. BANTLI)(GRİ)	1mt. 25	2mt. 50	71,23
001 008 040060 XX 17	40x60	MEKS DELİKLİ KABLO KANALI(YPŞK. BANTLI)(GRİ)	1mt. 24	2mt. 48	96,15
001 008 060040 XX 17	60x40	MEKS DELİKLİ KABLO KANALI(YPŞK. BANTLI)(GRİ)	1mt. 24	2mt. 48	99,38
001 008 060060 XX 17	60x60	MEKS DELİKLİ KABLO KANALI(YPŞK. BANTLI)(GRİ)	1mt. 16	2mt. 32	126,47
001 008 060080 XX 17	60x80	MEKS DELİKLİ KABLO KANALI(YPŞK. BANTLI)(GRİ)	1mt. 12	2mt. 24	152,10
001 008 060100 XX 17	60x100	MEKS DELİKLİ KABLO KANALI(YPŞK. BANTLI)(GRİ)	1mt. 8	2mt. 16	170,92
001 008 040080 XX 17	40x80	MEKS DELİKLİ KABLO KANALI(YPŞK. BANTLI)(GRİ)	1mt. 18	2mt. 36	146,57
001 008 080060 XX 17	80x60	MEKS DELİKLİ KABLO KANALI(YPŞK. BANTLI)(GRİ)	1mt. 12	2mt. 24	182,54
001 008 100060 XX 17	100x60	MEKS DELİKLİ KABLO KANALI(YPŞK. BANTLI)(GRİ)	1mt. 8	2mt. 16	233,83
001 008 100100 XX 17	100x100	MEKS DELİKLİ KABLO KANALI(YPŞK. BANTLI)(GRİ)	1mt. 4	2mt. 8	303,24

### YAPIŞKAN BANTLI MEKS DELİKLİ KABLO KANALLAR (MAVİ)

001 008 025025 XX 13	25x25	MEKS DELİKLİ KABLO KANALI(YPŞK. BANTLI)(MAVİ)	1mt. 64	2mt. 120	46,26
001 008 025040 XX 13	25x40	MEKS DELİKLİ KABLO KANALI(YPŞK. BANTLI)(MAVİ)	1mt. 40	2mt. 80	58,45
001 008 025060 XX 13	25x60	MEKS DELİKLİ KABLO KANALI(YPŞK. BANTLI)(MAVİ)	1mt. 36	2mt. 80	99,36
001 008 040040 XX 13	40x40	MEKS DELİKLİ KABLO KANALI(YPŞK. BANTLI)(MAVİ)	1mt. 25	2mt. 50	75,66
001 008 040060 XX 13	40x60	MEKS DELİKLİ KABLO KANALI(YPŞK. BANTLI)(MAVİ)	1mt. 24	2mt. 48	99,66
001 008 060040 XX 13	60x40	MEKS DELİKLİ KABLO KANALI(YPŞK. BANTLI)(MAVİ)	1mt. 24	2mt. 48	103,58
001 008 060060 XX 13	60x60	MEKS DELİKLİ KABLO KANALI(YPŞK. BANTLI)(MAVİ)	1mt. 16	2mt. 32	133,92
001 008 060080 XX 13	60x80	MEKS DELİKLİ KABLO KANALI(YPŞK. BANTLI)(MAVİ)	1mt. 12	2mt. 24	162,74
001 008 060100 XX 13	60x100	MEKS DELİKLİ KABLO KANALI(YPŞK. BANTLI)(MAVİ)	1mt. 8	2mt. 16	182,51
001 008 040080 XX 13	40x80	MEKS DELİKLİ KABLO KANALI(YPŞK. BANTLI)(MAVİ)	1mt. 18	2mt. 36	171,04
001 008 080060 XX 13	80x60	MEKS DELİKLİ KABLO KANALI(YPŞK. BANTLI)(MAVİ)	1mt. 12	2mt. 24	208,10
001 008 100060 XX 13	100x60	MEKS DELİKLİ KABLO KANALI(YPŞK. BANTLI)(MAVİ)	1mt. 8	2mt. 16	260,93
001 008 100100 XX 13	100x100	MEKS DELİKLİ KABLO KANALI(YPŞK. BANTLI)(MAVİ)	1mt. 4	2mt. 8	350,08

Ürün Kodu	Ölçü (mm)	Ürün Adı	Ambalaj Kutu /Adet	Fiyat (₺)
-----------	-----------	----------	--------------------	-----------

### KABLO TUTUCUCU APARATI

001 050 010001 00 00	25x40	KABLO TUTUCUCU APARATI	50	23,82
001 050 010002 00 00	40x40	KABLO TUTUCUCU APARATI	50	25,07
001 050 010003 00 00	60x40	KABLO TUTUCUCU APARATI	50	25,49

### KABLO TUTUCUCU YAN APARATI

001 050 020001 00 00	40X40/60	KABLO TUTUCUCU YAN APARATI	100	7,53
001 050 020002 00 00	60X40/60	KABLO TUTUCUCU YAN APARATI	100	7,73
001 050 020004 00 00	100X60	KABLO TUTUCUCU YAN APARATI	100	13,72

### KANAL KESME MAKASI

999 999 777139		PDC110 KANAL KESME MAKASI 60MM	1	540,18 €
----------------	--	--------------------------------	---	----------

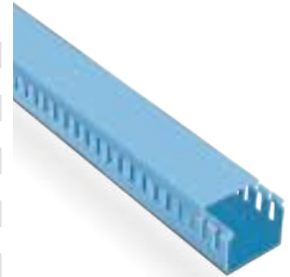
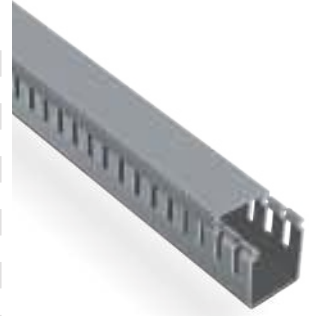

KANAL KESME MAKASI







Poliüretan  
Sızdırmazlık

IP65 CE

## OPAK KAPAKLI ABS PANOLAR

Ürün Kodu	Ölçü (mm)	Ürün Adı	Ağırlık (kg)	Adet	Fiyat (₺)
001 046 203013 00 17	20x30x13	PLASTİK OPAK KAPAKLI PANO	1,70	1	627,89
001 046 253515 00 17	25x35x15	PLASTİK OPAK KAPAKLI PANO	2,20	1	910,84
001 046 304017 00 17	30x40x17	PLASTİK OPAK KAPAKLI PANO	3,00	1	1.124,43
001 046 304022 00 17	30x40x22	PLASTİK OPAK KAPAKLI PANO	3,40	1	1.315,90
001 046 355019 00 17	35x50x19	PLASTİK OPAK KAPAKLI PANO	4,30	1	1.632,40
001 046 405018 00 17	40x50x18	PLASTİK OPAK KAPAKLI PANO	4,30	1	1.806,85
001 046 405024 00 17	40x50x24	PLASTİK OPAK KAPAKLI PANO	5,60	1	2.047,56
001 046 406020 00 17	40x60x20	PLASTİK OPAK KAPAKLI PANO	6,00	1	2.238,01
001 046 507025 00 17	50x70x25	PLASTİK OPAK KAPAKLI PANO	10,10	1	3.459,19
001 046 608026 00 17	60x80x26	PLASTİK OPAK KAPAKLI PANO	13,50	1	5.447,13

## ŞEFFAF KAPAKLI ABS PANOLAR

Ürün Kodu	Ölçü (mm)	Ürün Adı	Ağırlık (kg)	Adet	Fiyat (₺)
001 046 203013 00 44	20x30x13	PLASTİK ŞEFFAF KAPAKLI PANO	1,70	1	675,88
001 046 253515 00 44	25x35x15	PLASTİK ŞEFFAF KAPAKLI PANO	2,20	1	947,00
001 046 304017 00 44	30x40x17	PLASTİK ŞEFFAF KAPAKLI PANO	3,00	1	1.162,95
001 046 304022 00 44	30x40x22	PLASTİK ŞEFFAF KAPAKLI PANO	3,40	1	1.359,67
001 046 355019 00 44	35x50x19	PLASTİK ŞEFFAF KAPAKLI PANO	4,30	1	1.693,08
001 046 405018 00 44	40x50x18	PLASTİK ŞEFFAF KAPAKLI PANO	4,30	1	1.859,85
001 046 405024 00 44	40x50x24	PLASTİK ŞEFFAF KAPAKLI PANO	5,60	1	2.207,28
001 046 406020 00 44	40x60x20	PLASTİK ŞEFFAF KAPAKLI PANO	6,00	1	2.306,29
001 046 507025 00 44	50x70x25	PLASTİK ŞEFFAF KAPAKLI PANO	10,10	1	3.569,62
001 046 608026 00 44	60x80x26	PLASTİK ŞEFFAF KAPAKLI PANO	13,50	1	5.622,93



IP65 CE

## OPAK KAPAKLI ABS OTOMAT PANOLAR

Ürün Kodu	Ölçü (mm)	Ürün Adı	Ağırlık (kg)	Adet	Fiyat (₺)
001 046 253515 01 17	25x35x15	18 OTOMATLI (9x2)	2,50	1	1.678,91
001 046 304017 01 17	30x40x17	24 OTOMATLI (12x2)	3,40	1	1.994,66
001 046 355019 01 17	35x50x19	45 OTOMATLI (15x3)	4,50	1	2.538,62
001 046 406020 01 17	40x60x20	60 OTOMATLI (15x4)	6,00	1	3.025,03



IP65 CE

## ŞEFFAF KAPAKLI ABS OTOMAT PANOLAR

Ürün Kodu	Ölçü (mm)	Ürün Adı	Ağırlık (kg)	Adet	Fiyat (₺)
001 046 253515 01 44	25x35x15	18 OTOMATLI (9x2)	2,50	1	1.710,12
001 046 304017 01 44	30x40x17	24 OTOMATLI (12x2)	3,40	1	2.031,07
001 046 355019 01 44	35x50x19	45 OTOMATLI (15x3)	4,50	1	2.594,97
001 046 406020 01 44	40x60x20	60 OTOMATLI (15x4)	6,00	1	3.273,03



## PANO PRİZLERİ



ÜRÜN KODU	010 104 000157
ÜRÜN ADI	MRP-16 1x16 RAY TİPİ PANO PRİZİ
AMB. AD./KOLİ	10
FİYAT (₺)	216,76



ÜRÜN KODU	010 104 000158
ÜRÜN ADI	MRP-LED 10x16 RAY TİPİ PANO PRİZİ - LEDLİ
AMB. AD./KOLİ	10
FİYAT (₺)	277,23



ÜRÜN KODU	010 104 000159
ÜRÜN ADI	MRP-UPS 1X16 RAY TİPİ PANO PRİZİ - UPS
AMB. AD./KOLİ	10
FİYAT (₺)	277,23



## GALVANİZ TABAN SAÇLARI

Ürün Kodu	Ölçü (mm)	Ürün Adı	Adet	Fiyat (₺)
000 702 203013 00 00	20x30x13	GALVANİZ TABAN SAÇI 1mm	1	148,62
000 702 253515 00 00	25x35x15	GALVANİZ TABAN SAÇI 1mm	1	168,14
000 702 304017 00 00	30x40x17	GALVANİZ TABAN SAÇI 1mm	1	219,50
000 702 304022 00 00	30x40x22	GALVANİZ TABAN SAÇI 1mm	1	225,66
000 702 355019 00 00	35x50x19	GALVANİZ TABAN SAÇI 1mm	1	321,51
000 702 405018 00 00	40x50x17,5	GALVANİZ TABAN SAÇI 1mm	1	378,95
000 702 405024 00 00	40x50x24	GALVANİZ TABAN SAÇI 1mm	1	369,90
000 702 406020 00 00	40x60x20	GALVANİZ TABAN SAÇI 1mm	1	436,06
000 702 507025 00 00	50x70x25	GALVANİZ TABAN SAÇI 1mm	1	655,12



## MODÜLER KİTLER ve SEPERATÖRLER

Ürün Kodu	Ölçü (mm)	Ürün Adı	Adet	Fiyat (₺)
000 700 253515 01 17	25X35X15	18 OTOMATLI (9X2)	1	1.067,46
000 700 304017 01 17	30X40X17	24 OTOMATLI (12X2)	1	1.208,38
000 700 355019 01 17	35X50X19	45 OTOMATLI (15X3)	1	1.649,03
000 700 406020 01 17	40X60X20	60 OTOMATLI (15X4)	1	1.721,71
000 700 253515 00 17	25X35X15	PLASTİK PERDE	1	139,06
000 700 304017 00 17	30X40X17	PLASTİK PERDE	1	182,56
000 700 355019 00 17	35X50X19	PLASTİK PERDE	1	291,76
000 700 406020 00 17	40X60X20	PLASTİK PERDE	1	323,93



## PANO AKSESUARLARI

Ürün Kodu	Ürün Adı	Adet	Fiyat (₺)
000 700 000700 00 17	PANO KİLİT GÖBEK TAKIMI (SET)	1	39,62
000 700 000701 00 17	PANO AKSESUARİ (4'LÜ SET)	1	36,49
000 700 000702 00 17	PLASTİK PANO ÜÇGEN ANAHTAR	1	22,83
000 700 000703 00 17	PANO SEPERATÖRÜ TUTTURMA VİDASI	1	18,57
000 700 000704 00 17	PLASTİK KİLİTLENEBİLİR PANO (METAL) KİLİDİ	1	156,83

## DİJİTAL TERMOSTAT ve HİGROSTAT

### PDT 50-150 SICAKLIK KONTROL CİHAZI

ÜRÜN KODU	048 095 000304
ÖLÇÜLER	36x90x65mm RAYA MONTAJ
GÖSTERGE	3 HANE 7 SEGMENT
SENSÖR	PTC
ÖLÇME SKALASI	-50...+150 °C
DUYARLILIK	± C
DOĞRULUK	±%1 (Tam Skalanın)
KONTROL DURUMU	ON-OFF
OUT ÇIKIŞI	RÖLE, 250V AC, 2A, REZİSTİF YÜK
ALARM ÇIKIŞI	RÖLE, 250V AC, 2A, REZİSTİF YÜK
HEAT SET AYARI	LoL...UPL C (Hst)
ALARM SET AYARI	AtP=Abs,-Ab; LoL...C(Ast) Atp=rEL, -rL; (HSt+rAL), (HSt-20)...(Hst+20) C
HEAT HİSTERESİZ	1...20 C (Hhs)
ALARM HİSTERESİZ	1...20 C (Hhs)
OFFSET	-20...+20 °C
ISITMA / SOĞUTMA	H-C; Ht(Isıtma), CL (Soğutma); SEÇMELİ
BESLEME VOLTAJ	100...240V AC, 50/60 Hz
GÜÇ TÜKETİMİ	<6VA
ÇALIŞMA SICAKLIĞI	-20 °C...55 °C
İŞLETME İRTİFASI	<2000m
ADET	1
FİYAT	194,49 \$

\* NOT: PTC SENSÖR CİHAZ DAHİLİNDEDİR.



### HT-310 SICAKLIK VE NEM KONTROL CİHAZI

ÜRÜN KODU	048 095 000305
ÖLÇÜLER	35x77mm
GÖSTERGE	3 HANE 7 SEGMENT
SENSÖR	DİJİTAL SICAKLIK NEM SENSÖRÜ
ÖLÇME SKALASI	-19,9...+80,0C, 5...95%RH
DUYARLILIK	±0,1C, ±1%RH
DOĞRULUK	±%1 (C), ±%3 (%RH) (Tam Skalanın)
KONTROL DURUMU	ON-OFF
C OUT ÇIKIŞI	RÖLE (NA+NK), 250V AC, 2A, REZİSTİF YÜK
%RH OUT ÇIKIŞI	RÖLE (NA), 250V AC, 2A, REZİSTİF YÜK
ISITMA / SOĞUTMA	Ht(Isıtma), CL (Soğutma); SEÇMELİ
BESLEME VOLTAJ	100...220V AC, 50/60 Hz
GÜÇ TÜKETİMİ	<6VA
ÇALIŞMA SICAKLIĞI	0°C...55°C
İŞLETME İRTİFASI	<2000m
ADET	1
FİYAT	222,96 \$

\* NOT: SICAKLIK VE NEM SENSÖRÜ CİHAZ DAHİLİNDEDİR.



# ENERJİ TASARRUFU SAĞLAR

Doğru sıcaklık değerini korumak için ısıtma veya soğutma cihazlarını açıp kapatarak veya bir ısı transfer sıvısının akışını gerektiği gibi düzenleyerek kontrol yapar.



## PROMEX SERİSİ THERMOSTAT ve HİGROSTAT



### ISITMA THERMOSTAT - NK

ÜRÜN KODU	048 095 000300
AYAR SAHASI	0-60°C
KONTAK TİPİ	NK
KORUMA SINIFI	IP20
AĞIRLIK	45 GR
ADET / KOLİ	135
FİYAT	11,39 \$

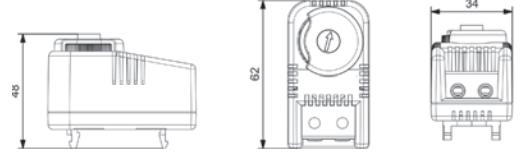

### SOĞUTMA THERMOSTAT - NA

ÜRÜN KODU	048 095 000301
AYAR SAHASI	0-60°C
KONTAK TİPİ	NA
KORUMA SINIFI	IP20
AĞIRLIK	45 GR
ADET / KOLİ	135
FİYAT	11,39 \$

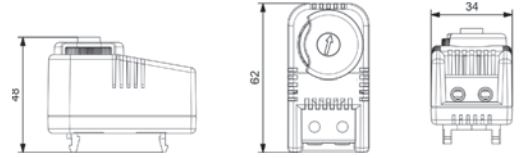

### DUAL THERMOSTAT - NK+NA

ÜRÜN KODU	048 095 000302
AYAR SAHASI	0-60°C / 0-60°C
KONTAK TİPİ	NK+NA
KORUMA SINIFI	IP20
AĞIRLIK	80 GR
ADET / KOLİ	60
FİYAT	23,27 \$

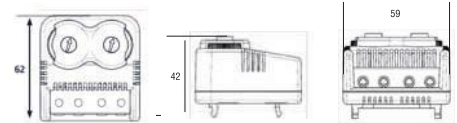

### MEKANİK HİGROSTAT - 1CO

ÜRÜN KODU	048 095 000303
AYAR SAHASI	%10-90RH
KONTAK TİPİ	1CO
KORUMA SINIFI	IP20
AĞIRLIK	180 GR
ADET / KOLİ	30
FİYAT	90,13 \$

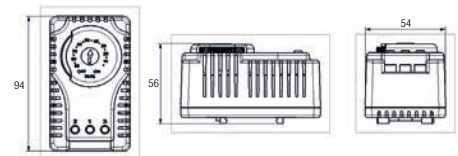

# ECOFAN SERİSİ THERMOSTAT ve HİGROSTAT



## SOĞUTUCU THERMOSTAT

ÜRÜN KODU	048 095 101141
AYAR SAHASI	0-60°C
KONTAK TİPİ	NO
KORUMA SINIFI	IP20
AĞIRLIK	45 GR
ADET / KOLİ	1
FİYAT	6,55 \$

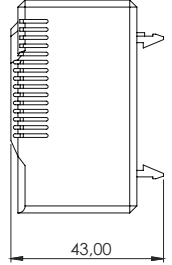
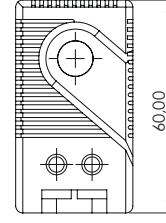
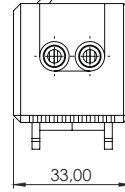

## ISITICI THERMOSTAT

ÜRÜN KODU	048 095 101140
AYAR SAHASI	0-60°C
KONTAK TİPİ	NC
KORUMA SINIFI	IP20
AĞIRLIK	45 GR
ADET / KOLİ	1
FİYAT	6,55 \$

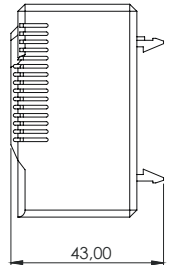
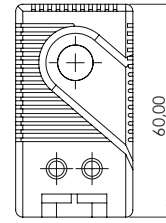
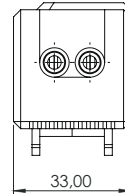

## MULTİ THERMOSTAT

ÜRÜN KODU	048 095 101142
AYAR SAHASI	0-60°C / 0-60°C
KONTAK TİPİ	NC+NO
KORUMA SINIFI	IP20
AĞIRLIK	80 GR
ADET / KOLİ	1
FİYAT	22,59 \$

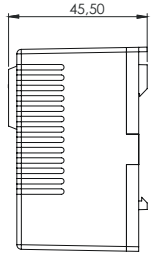
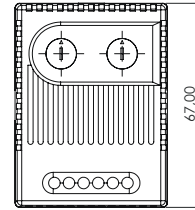
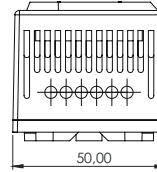

## HİGROSTAT

ÜRÜN KODU	048 095 101143
AYAR SAHASI	%40-90RH
KONTAK TİPİ	1CO
KORUMA SINIFI	IP20
AĞIRLIK	180 GR
ADET / KOLİ	1
FİYAT	67,77 \$

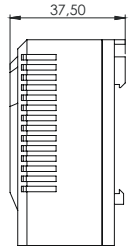
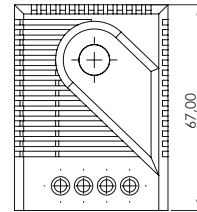
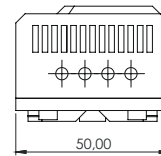

## ODA THERMOSTAT

ÜRÜN KODU	048 095 101144
AYAR SAHASI	%10-90RH
KONTAK TİPİ	1CO
KORUMA SINIFI	IP20
AĞIRLIK	180 GR
ADET / KOLİ	1
FİYAT	72,29 \$

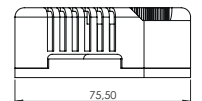
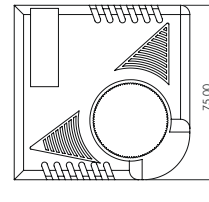



## POMEX SERİSİ TEPE FANLARI



IP54



Poliüretan Conta



Radyal Fan

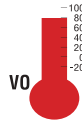

VO Alev İletmez ABS

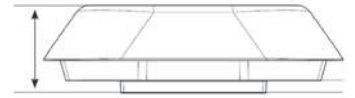
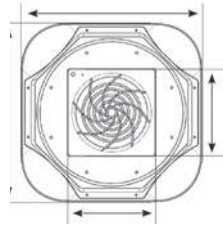

### TEPE FANLARI

Ürün Kodu	Fan Tipi	Besleme	Güç (W)	Nominal Akım	Gürültü Seviyesi	Kapasite	Adet	Fiyat
048 095 000100	Ø172x163x51 AKSİYEL	220V AC 50/60 Hz	25/32W	0,11/0,15A	57 dB	400 m³/h	1	128,08 \$
048 095 000101	Ø190x68 RADYAL	220V AC 50/60 Hz	58/75W	0,26/0,34A	62 dB	560 m³/h	1	192,14 \$
048 095 000102	Ø220X71 RADYAL	220V AC 50/60 Hz	85/90W	0,38/0,44A	73 dB	970 m³/h	1	224,4 \$



Vidasız hızlı ve kolay montaj !



IP54



Poliüretan Conta



Radyal Fan

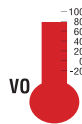

VO Alev İletmez ABS



Hızlı ve Kolay Montaj

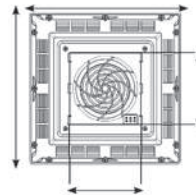

Ürün Kodu	Fan Tipi	Besleme	Güç (W)	Nominal Akım	Gürültü Seviyesi	Kapasite	Adet	Fiyat
048 095 000200	Ø172x163x51 AKSİYEL	220V AC 50/60 Hz	25/32W	0,11/0,15A	57 dB	400 m³/h	1	128,08 \$
048 095 000201	Ø190x68 RADYAL	220V AC 50/60 Hz	58/75W	0,26/0,34A	62 dB	560 m³/h	1	192,14 \$
048 095 000202	Ø220X71 RADYAL	220V AC 50/60 Hz	85/90W	0,38/0,44A	73 dB	970 m³/h	1	224,4 \$

## ECOFAN SERİSİ TEPE FANLARI



IP54



Poliüretan Conta



Radyal Fan

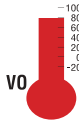

VO Alev İletmez ABS

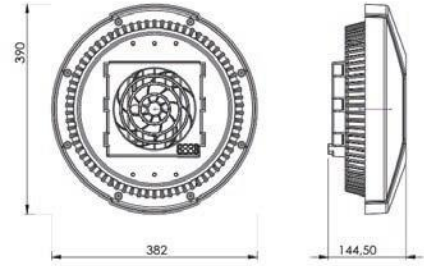

### TEPE FANLARI

Ürün Kodu	Fan Tipi	Besleme	Güç (W)	Nominal Akım	Gürültü Seviyesi	Kapasite	Adet	Fiyat (\$)
048 095 100100	MTF300	230V AC 50/60 Hz	35W	0,15A	51 dB	300 m³/h	1	126,5 \$
048 095 100101	MTF 600	230V AC 50/60 Hz	65W	0,30A	60 dB	634 m³/h	1	153,61 \$
048 095 100102	MTF 900	230V AC 50/60 Hz	90W	0,48A	60 dB	900 m³/h	1	167,16 \$
048 095 100103	MTF 1200	230V AC 50/60 Hz	90W	0,48A	90 dB	1200 m³/h	1	180,71 \$

## KOLAY MONTAJ FİLTRELER

ÜRÜN KODU	048 095 000400
ÖLÇÜ	120x120x20,5 mm
KESİM ÖLÇÜSÜ	92x92 mm
KORUMA SINIFI	IP54
ADET / KOLİ	200
FİYAT	6,64 \$



ÜRÜN KODU	048 095 000401
ÖLÇÜ	160x160x31 mm
KESİM ÖLÇÜSÜ	125x125 mm
KORUMA SINIFI	IP54
ADET / KOLİ	100
FİYAT	8,09 \$



ÜRÜN KODU	048 095 000402
ÖLÇÜ	210x210x31 mm
KESİM ÖLÇÜSÜ	177x177 mm
KORUMA SINIFI	IP54
ADET / KOLİ	100
FİYAT	12,83 \$



ÜRÜN KODU	048 095 000403
ÖLÇÜ	260x260x31 mm
KESİM ÖLÇÜSÜ	223x223 mm
KORUMA SINIFI	IP54
ADET / KOLİ	50
FİYAT	18,52 \$



ÜRÜN KODU	048 095 000404
ÖLÇÜ	325x325x31 mm
KESİM ÖLÇÜSÜ	291x291 mm
KORUMA SINIFI	IP54
ADET / KOLİ	50
FİYAT	32,01 \$



## PROJE CEPLERİ

ÜRÜN KODU	048 095 000902
ÜRÜN ADI	PROJE CEBİ A4
ADET / KOLİ	10
FİYAT	4,74 \$

ÜRÜN KODU	048 095 000903
ÜRÜN ADI	PROJE CEBİ A5
ADET / KOLİ	10
FİYAT	3,8 \$



## FİLTRELİ FANLAR



ÜRÜN KODU	048 095 000500
ÖLÇÜ (mm)	120x120x58,5
KESİM ÖLÇÜSÜ (mm)	92x92
FAN TİPİ	80x80x38
BESLEME (V AC)	230V-50/60Hz
GÜÇ (W)	14 (13)
HIZ (rpm)	2800
FİLTRELİ (m <sup>3</sup> /h)	30
FİLTRESİZ (m <sup>3</sup> /h)	41
NOMİNAL AKIM	0,08 / 0,07
GÜRÜLTÜ SEVİYESİ (db)	28 (31)
AD. / FİYAT	38,45 \$



ÜRÜN KODU	048 095 000501
ÖLÇÜ (mm)	160x160x69
KESİM ÖLÇÜSÜ (mm)	125x125
FAN TİPİ	120x120x38
BESLEME (V AC)	230V-50/60Hz
GÜÇ (W)	26 (23)
HIZ (rpm)	2700
FİLTRELİ (m <sup>3</sup> /h)	100
FİLTRESİZ (m <sup>3</sup> /h)	140
NOMİNAL AKIM	0,14 / 0,13
GÜRÜLTÜ SEVİYESİ (db)	42 (46)
AD. / FİYAT	45,09 \$



ÜRÜN KODU	048 095 000502
ÖLÇÜ (mm)	120x120x58,5
KESİM ÖLÇÜSÜ (mm)	92x92
FAN TİPİ	80x80x38
BESLEME (V AC)	230V-50/60Hz
GÜÇ (W)	14 (13)
HIZ (rpm)	2800
FİLTRELİ (m <sup>3</sup> /h)	30
FİLTRESİZ (m <sup>3</sup> /h)	41
NOMİNAL AKIM	0,8 / 0,7
GÜRÜLTÜ SEVİYESİ (db)	28 (31)
AD. / FİYAT	45,09 \$



ÜRÜN KODU	048 095 000600
ÖLÇÜ (mm)	160x160x69
KESİM ÖLÇÜSÜ (mm)	125x125
FAN TİPİ	120x120x38
BESLEME (V AC)	230V-50/60Hz
GÜÇ (W)	26 (23)
HIZ (rpm)	2700
FİLTRELİ (m <sup>3</sup> /h)	100
FİLTRESİZ (m <sup>3</sup> /h)	140
NOMİNAL AKIM	0,14 / 0,13
GÜRÜLTÜ SEVİYESİ (db)	42 (46)
AD. / FİYAT	51,23 \$



ÜRÜN KODU	048 095 000601
ÖLÇÜ (mm)	210x210x98
KESİM ÖLÇÜSÜ (mm)	177x177
FAN TİPİ	120x120x38
BESLEME (V AC)	230V-50/60Hz
GÜÇ (W)	26 (23)
HIZ (rpm)	2700
FİLTRELİ (m <sup>3</sup> /h)	125
FİLTRESİZ (m <sup>3</sup> /h)	175
NOMİNAL AKIM	0,14 / 0,13
GÜRÜLTÜ SEVİYESİ (db)	42 (46)
AD. / FİYAT	71,16 \$



ÜRÜN KODU	048 095 000602
ÖLÇÜ (mm)	210x210x83
KESİM ÖLÇÜSÜ (mm)	177x177
FAN TİPİ	173x163x51
BESLEME (V AC)	230V-50/60Hz
GÜÇ (W)	37 (35)
HIZ (rpm)	2400
FİLTRELİ (m <sup>3</sup> /h)	175
FİLTRESİZ (m <sup>3</sup> /h)	245
NOMİNAL AKIM	0,23 / 0,22
GÜRÜLTÜ SEVİYESİ (db)	52 (53)
AD. / FİYAT	89,68 \$

## FİLTRELİ FANLAR

ÜRÜN KODU	048 095 000603
ÖLÇÜ (mm)	260x260x103
KESİM ÖLÇÜSÜ (mm)	223x223
FAN TİPİ	120x120x38
BESLEME (V AC)	230V-50/60Hz
GÜÇ (W)	26 (23)
HIZ (rpm)	2700
FİLTRELİ (m <sup>3</sup> /h)	115
FİLTRESİZ (m <sup>3</sup> /h)	130
NOMİNAL AKIM	0,14 / 0,13
GÜRÜLTÜ SEVİYESİ (db)	42 (46)
AD. / FİYAT	76,85 \$



ÜRÜN KODU	048 095 000604
ÖLÇÜ (mm)	260x260x116
KESİM ÖLÇÜSÜ (mm)	223x223
FAN TİPİ	172x1263x51
BESLEME (V AC)	230V-50/60Hz
GÜÇ (W)	37 (35)
HIZ (rpm)	2400
FİLTRELİ (m <sup>3</sup> /h)	240
FİLTRESİZ (m <sup>3</sup> /h)	270
NOMİNAL AKIM	0,23 / 0,22
GÜRÜLTÜ SEVİYESİ (db)	52 (53)
AD. / FİYAT	102,47 \$



ÜRÜN KODU	048 095 000605
ÖLÇÜ (mm)	260x260x111
KESİM ÖLÇÜSÜ (mm)	223x223
FAN TİPİ	225x225x80
BESLEME (V AC)	230V-50/60Hz
GÜÇ (W)	66 (75)
HIZ (rpm)	2600
FİLTRELİ (m <sup>3</sup> /h)	650
FİLTRESİZ (m <sup>3</sup> /h)	900
NOMİNAL AKIM	0,35 / 0,38
GÜRÜLTÜ SEVİYESİ (db)	60 (63)
AD. / FİYAT	256,16 \$



ÜRÜN KODU	048 095 000606
ÖLÇÜ (mm)	325x325x145
KESİM ÖLÇÜSÜ (mm)	291x291
FAN TİPİ	225x225x80
BESLEME (V AC)	230V-50/60Hz
GÜÇ (W)	66 (75)
HIZ (rpm)	2600
FİLTRELİ (m <sup>3</sup> /h)	700
FİLTRESİZ (m <sup>3</sup> /h)	950
NOMİNAL AKIM	0,35 / 0,38
GÜRÜLTÜ SEVİYESİ (db)	60 (63)
AD. / FİYAT	279,88 \$



ÜRÜN KODU	048 095 000607
ÖLÇÜ (mm)	325x325x111
KESİM ÖLÇÜSÜ (mm)	291x291
FAN TİPİ	280x280x80
BESLEME (V AC)	230V-50/60Hz
GÜÇ (W)	110 (140)
HIZ (rpm)	2600
FİLTRELİ (m <sup>3</sup> /h)	850
FİLTRESİZ (m <sup>3</sup> /h)	1200
NOMİNAL AKIM	0,50 / 0,72
GÜRÜLTÜ SEVİYESİ (db)	65 (68)
AD. / FİYAT	288,42 \$





MINİ ISITICI



PTC ISITICI



SLİM ISITICI

## PANO ISITICILARI

Ürün Kodu	Ürün Adı	Besleme	Koruma Sınıfı	Ölçüler (AxBxC)mm	Bağlantı	Adet	Fiyat
048 095 000700	15W PTC PANO ISITICISI	100-250V AC-DC	IP20	60x50x27	KABLO	1	41,95 \$
048 095 000701	25W PTC PANO ISITICISI	100-250V AC-DC	IP20	70x50x27	KABLO	1	49,34 \$
048 095 000702	30W PTC PANO ISITICISI	100-250V AC-DC	IP20	128x70x59	KLEMENS	1	61,67 \$
048 095 000703	50W PTC PANO ISITICISI	100-250V AC-DC	IP20	138x70x59	KLEMENS	1	74,00 \$
048 095 000704	75W PTC PANO ISITICISI	100-250V AC-DC	IP20	178x70x59	KLEMENS	1	117,19 \$
048 095 000705	100W PTC PANO ISITICISI	100-250V AC-DC	IP20	188x70x59	KLEMENS	1	125,19 \$
048 095 000706	150W PTC PANO ISITICISI	100-250V AC-DC	IP20	228x70x59	KLEMENS	1	141,86 \$
048 095 000707	30W SLIM PTC PANO ISITICISI	100-250V AC-DC	IP20	128x27x80	KLEMENS	1	58,58 \$
048 095 000708	50W SLIM PTC PANO ISITICISI	100-250V AC-DC	IP20	138x27x80	KLEMENS	1	66,62 \$
048 095 000709	75W SLIM PTC PANO ISITICISI	100-250V AC-DC	IP20	178x27x80	KLEMENS	1	108,53 \$
048 095 000710	100W SLIM PTC PANO ISITICISI	100-250V AC-DC	IP20	188x27x80	KLEMENS	1	116,57 \$
048 095 000711	150W SLIM PTC PANO ISITICISI	100-250V AC-DC	IP20	228x27x80	KLEMENS	1	133,2 \$



FANLI PTC ISITICI



FANLI ISITICI



400W PLASTİK FANLI ISITICI

## FANLI PANO ISITICILARI

Ürün Kodu	Ürün Adı	Besleme	Koruma Sınıfı	Ölçüler (AxBxC)mm	Bağlantı	Adet	Fiyat
048 095 000800	100W FANLI PTC PANO ISITICISI	230V AC 50/60 Hz	IP20	170x89x60	KLEMENS	1	166,53 \$
048 095 000801	150W FANLI PTC PANO ISITICISI	230V AC 50/60 Hz	IP20	210x89x60	KLEMENS	1	233,10 \$
048 095 000802	250W FANLI REZİSTANS PANO ISITICISI	230V AC 50/60 Hz	IP20	152x110x80	KLEMENS	1	249,77 \$
048 095 000803	500W FANLI REZİSTANS PANO ISITICISI	230V AC 50/60 Hz	IP20	182x110x80	KLEMENS	1	283,68 \$
048 095 000804	750W FANLI REZİSTANS PANO ISITICISI	230V AC 50/60 Hz	IP20	232x110x80	KLEMENS	1	325,01 \$
048 095 000805	200/300/400W FANLI PTC PANO ISITICISI	230V AC 50/60 Hz	IP20	99x70x67	KABLO	1	291,06 \$



Ürün Kodu	Ürün Adı	Kutu Adet	Koli Adet	Fiyat (₺)
-----------	----------	-----------	-----------	-----------

### SÜPER ETANJ PLASTİK RAKORLAR C€

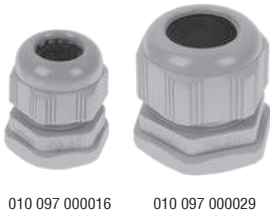

010 097 000007	PG-7 PLASTİK RAKOR	450 ad.	4500	7,04
010 097 000009	PG-9 PLASTİK RAKOR	300 ad.	3000	8,11
010 097 000011	PG-11 PLASTİK RAKOR	200 ad.	2000	10,14
010 097 000135	PG-13,5 PLASTİK RAKOR	175 ad.	1750	11,21
010 097 000016	PG-16 PLASTİK RAKOR	125 ad.	1250	13,54
010 097 000021	PG-21 PLASTİK RAKOR	75 ad.	750	19,68
010 097 000029	PG-29 PLASTİK RAKOR	40 ad.	400	31,19
010 097 000036	PG-36 PLASTİK RAKOR	20 ad.	200	57,85
010 097 000042	PG-42 PLASTİK RAKOR	15 ad.	150	74,84
010 097 000048	PG-48 PLASTİK RAKOR	12 ad.	120	85,88

### POLYAMİD SİRAL RAKORU

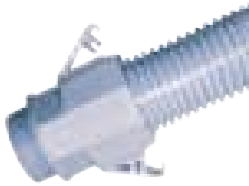

057 097 110007	PSR-7 SİRAL RAKORU (GRİ-SİYAH)	50 ad.		0,83 €
057 097 110009	PSR-9 SİRAL RAKORU (GRİ-SİYAH)	50 ad.		0,83 €
057 097 110011	PSR-11 SİRAL RAKORU (GRİ-SİYAH)	50 ad.		0,87 €
057 097 110135	PSR-13,5 SİRAL RAKORU (GRİ-SİYAH)	50 ad.		1,00 €
057 097 110016	PSR-16 SİRAL RAKORU (GRİ-SİYAH)	50 ad.		1,08 €
057 097 110021	PSR-21 SİRAL RAKORU (GRİ-SİYAH)	25 ad.		1,50 €
057 097 110029	PSR-29 SİRAL RAKORU (GRİ-SİYAH)	20 ad.		2,50 €
057 097 110036	PSR-36 SİRAL RAKORU (GRİ-SİYAH)	10 ad.		3,50 €
057 097 110048	PSR-48 SİRAL RAKORU (GRİ-SİYAH)	1 ad.		4,79 €

### POLYAMİD SİRAL DİRSEĞİ



057 097 120007	PSRD-7 SİRAL RAKORU 90° DİRSEK (GRİ-SİYAH)	1 ad.		1,16 €
057 097 120009	PSRD-9 SİRAL RAKORU 90° DİRSEK (GRİ-SİYAH)	1 ad.		1,24 €
057 097 120011	PSRD-11 SİRAL RAKORU 90° DİRSEK (GRİ-SİYAH)	1 ad.		1,36 €
057 097 120135	PSRD-13,5 SİRAL RAKORU 90° DİRSEK (GRİ-SİYAH)	1 ad.		1,61 €
057 097 120016	PSRD-16 SİRAL RAKORU 90° DİRSEK (GRİ-SİYAH)	1 ad.		1,86 €
057 097 120021	PSRD-21 SİRAL RAKORU 90° DİRSEK (GRİ-SİYAH)	1 ad.		2,97 €

### POLYAMİD SİRAL KROŞELERİ



057 097 160007	PG-7 POLYAMİD SİRAL KROŞESİ (GRİ-SİYAH)	50 ad.		0,61 €
057 097 160009	PG-9 POLYAMİD SİRAL KROŞESİ (GRİ-SİYAH)	50 ad.		0,61 €
057 097 160011	PG-11 POLYAMİD SİRAL KROŞESİ (GRİ-SİYAH)	50 ad.		0,61 €
057 097 160135	PG-13,5 POLYAMİD SİRAL KROŞESİ (GRİ-SİYAH)	50 ad.		0,65 €
057 097 160016	PG-16 POLYAMİD SİRAL KROŞESİ (GRİ-SİYAH)	50 ad.		0,69 €
057 097 160021	PG-21 POLYAMİD SİRAL KROŞESİ (GRİ-SİYAH)	25 ad.		0,78 €
057 097 160029	PG-29 POLYAMİD SİRAL KROŞESİ (GRİ-SİYAH)	25 ad.		1,47 €
057 097 160036	PG-36 POLYAMİD SİRAL KROŞESİ (GRİ-SİYAH)	25 ad.		2,25 €
057 097 160048	PG-48 POLYAMİD SİRAL KROŞESİ (GRİ-SİYAH)	10 ad.		3,12 €

### PP POLYPROPİLEN SİRALLER C€



	Rakor Ölçüsü	Ort. İç Çap	Ort. Dış Çap				
001 020 160007 00 XX	MUT/PP-7 PP SİRAL BORU	PSR7	7	10,1	100 mt.	1000	5,25
001 020 160009 00 XX	MUT/PP-8,5 PP SİRAL BORU		8,4	12,05	100 mt.	1000	5,65
001 020 160010 00 XX	MUT/PP-10 PP SİRAL BORU	PSR9	10,2	13,1	100 mt.	1000	6,18
001 020 160012 00 XX	MUT/PP-12 PP SİRAL BORU	PSR11	12,3	15,9	50 mt.	500	8,71
001 020 160014 00 XX	MUT/PP-14 PP SİRAL BORU	PSR13,5	14,1	18,35	50 mt.	250	10,74
001 020 160017 00 XX	MUT/PP-17 PP SİRAL BORU	PSR16	17	21,45	50 mt.	250	13,40
001 020 160019 00 XX	MUT/PP-19 PP SİRAL BORU		19	24,25	50 mt.	250	15,02
001 020 160023 00 XX	MUT/PP-23 PP SİRAL BORU	PSR21	23,25	28,5	50 mt.	250	17,21
001 020 160026 00 XX	MUT/PP-26 PP SİRAL BORU		26,2	31,3	25 mt.	125	19,23
001 020 160029 00 XX	MUT/PP-29 PP SİRAL BORU	PSR29	29,1	34,3	25 mt.	125	21,47
001 020 160036 00 XX	MUT/PP-36 PP SİRAL BORU	PSR36	35,8	42,2	25 mt.	125	31,35
001 020 160048 00 XX	MUT/PP-48 PP SİRAL BORU	PSR48	48,5	54,5	25 mt.	125	38,28

### PA6 POLYAMİD SİRALLER (ALEV YAYMAYAN) C€



001 020 170007 00 XX	MUT/PA6-7 (A. YAYMAYAN)	PSR7	7	10,1	100 mt.	1000	9,11
001 020 170009 00 XX	MUT/PA6-8,5 (A. YAYMAYAN)		8,4	12,05	100 mt.	1000	9,90
001 020 170010 00 XX	MUT/PA6-10 (A. YAYMAYAN)	PSR9	10,2	13,1	100 mt.	1000	10,81
001 020 170012 00 XX	MUT/PA6-12 (A. YAYMAYAN)	PSR11	12,3	15,9	50 mt.	500	16,44
001 020 170014 00 XX	MUT/PA6-14 (A. YAYMAYAN)	PSR13,5	14,1	18,35	50 mt.	250	20,00
001 020 170017 00 XX	MUT/PA6-17 (A. YAYMAYAN)	PSR16	17	21,45	50 mt.	250	24,17
001 020 170019 00 XX	MUT/PA6-19 (A. YAYMAYAN)		19	24,25	50 mt.	250	29,70
001 020 170023 00 XX	MUT/PA6-23 (A. YAYMAYAN)	PSR21	23,25	28,5	50 mt.	250	33,04
001 020 170026 00 XX	MUT/PA6-26 (A. YAYMAYAN)		26,2	31,3	25 mt.	125	37,59
001 020 170029 00 XX	MUT/PA6-29 (A. YAYMAYAN)	PSR29	29,1	34,3	25 mt.	125	43,40
001 020 170036 00 XX	MUT/PA6-36 (A. YAYMAYAN)	PSR36	36,2	42,2	25 mt.	125	73,48
001 020 170048 00 XX	MUT/PA6-48 (A. YAYMAYAN)	PSR48	48,5	54,5	25 mt.	125	84,96

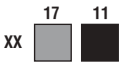

### POLYAMİD YARIKLI SİRAL BORU (ALEV YAYMAYAN)



001 020 470007 00 XX	Ø7 POLYAMİD YARIKLI SİRAL BORU(ALEV YAYMAYAN)				100 mt.	1000	9,75
001 020 470009 00 XX	Ø8,5 POLYAMİD YARIKLI SİRAL BORU(ALEV YAYMAYAN)				100 mt.	1000	10,59
001 020 470010 00 XX	Ø10 POLYAMİD YARIKLI SİRAL BORU(ALEV YAYMAYAN)				100 mt.	1000	11,57
001 020 470012 00 XX	Ø12 POLYAMİD YARIKLI SİRAL BORU(ALEV YAYMAYAN)				100 mt.	500	17,59
001 020 470014 00 XX	Ø14 POLYAMİD YARIKLI SİRAL BORU(ALEV YAYMAYAN)				50 mt.	250	21,02
001 020 470017 00 XX	Ø17 POLYAMİD YARIKLI SİRAL BORU(ALEV YAYMAYAN)				50 mt.	250	25,79
001 020 470019 00 XX	Ø19 POLYAMİD YARIKLI SİRAL BORU(ALEV YAYMAYAN)				50 mt.	250	32,47
001 020 470023 00 XX	Ø23 POLYAMİD YARIKLI SİRAL BORU(ALEV YAYMAYAN)				50 mt.	250	35,82
001 020 470026 00 XX	Ø26 POLYAMİD YARIKLI SİRAL BORU(ALEV YAYMAYAN)				25 mt.	125	40,22
001 020 470029 00 XX	Ø29 POLYAMİD YARIKLI SİRAL BORU(ALEV YAYMAYAN)				25 mt.	125	45,37
001 020 470036 00 XX	Ø36 POLYAMİD YARIKLI SİRAL BORU(ALEV YAYMAYAN)				25 mt.	125	76,40
001 020 470048 00 XX	Ø48 POLYAMİD YARIKLI SİRAL BORU(ALEV YAYMAYAN)				25 mt.	125	88,83



# KABLO BAĞLARI

Kendinden Kilitlemeli Sistem  
Kolay ve Hızlı Montaj  
1.Sınıf Malzeme



STANDART TİP

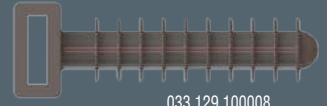

033 129 10008



062 129 171009



062 129 171011



062 129 132020  
062 129 132828

062 129 500003



062 129 151530

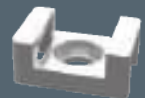

062 129 151017  
062 129 151723



062 129 142525 062 129 132525 062 129 191325

Beyaz Ürün Kodu	Siyah Ürün Kodu		Ürün Adı	Kutu Adet	Koli Adet	Fiyat (₺)
<b>MUTLUSAN KABLO BAĞLARI (SİYAH-BEYAZ) CE</b>						
062 129 025100	062 129 125100	2,5x100	KABLO BAĞI	1000 ad.	80000	0,217
062 129 025140	062 129 125140	2,5x140	KABLO BAĞI	100 ad.	50000	0,325
062 129 025200	062 129 125200	2,5x200	KABLO BAĞI	100 ad.	35000	0,476
062 129 036150	062 129 136150	3,6x150	KABLO BAĞI	100 ad.	30000	0,554
062 129 036205	062 129 136205	3,6x205	KABLO BAĞI	100 ad.	25000	0,723
062 129 036250	062 129 136250	3,6x250	KABLO BAĞI	100 ad.	22500	0,875
062 129 036300	062 129 136300	3,6x300	KABLO BAĞI	100 ad.	17500	1,074
062 129 036370	062 129 136370	3,6x370	KABLO BAĞI	100 ad.	16000	1,373
062 129 048200	062 129 148200	4,8x200	KABLO BAĞI	100 ad.	17000	1,066
062 129 048250	062 129 148250	4,8x250	KABLO BAĞI	100 ad.	15000	1,293
062 129 048300	062 129 148300	4,8x300	KABLO BAĞI	100 ad.	15000	1,611
062 129 048350	062 129 148350	4,8x350	KABLO BAĞI	100 ad.	12000	1,851
062 129 048400	062 129 148400	4,8x400	KABLO BAĞI	100 ad.	10000	2,105
062 129 048450	062 129 148450	4,8x450	KABLO BAĞI	100 ad.	10000	2,509
062 129 008250	062 129 108250	8x250	KABLO BAĞI	100 ad.	8000	2,586
062 129 008300	062 129 108300	8x300	KABLO BAĞI	100 ad.	6000	3,353
062 129 008380	062 129 108380	8x380	KABLO BAĞI	100 ad.	6000	3,644
062 129 008450	062 129 108450	8x450	KABLO BAĞI	100 ad.	5000	4,075
062 129 008550	062 129 108550	8x550	KABLO BAĞI	100 ad.	4000	5,463
062 129 008750	062 129 108750	8x750	KABLO BAĞI	100 ad.	2000	8,735
062 129 009762	062 129 109762	9x762	KABLO BAĞI	100 ad.	1500	11,648
062 129 009940	062 129 109940	9x940	KABLO BAĞI	100 ad.	1500	13,458

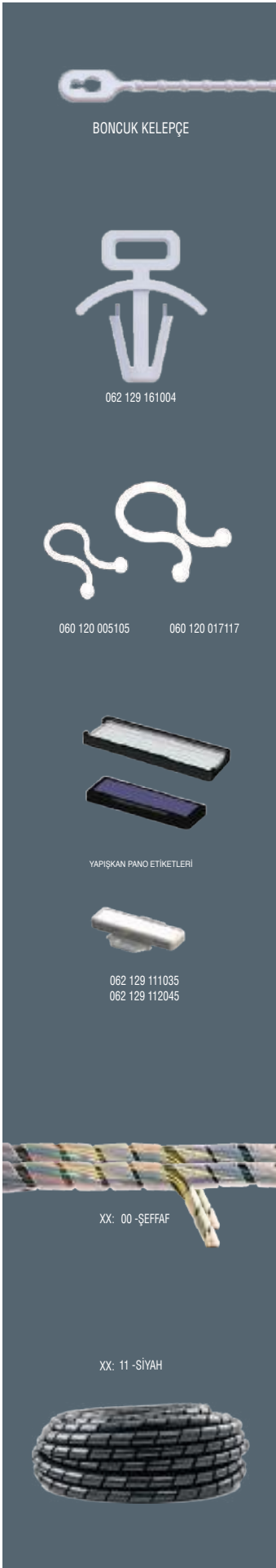

Ürün Kodu	Ürün Adı	Kutu Adet	Koli Adet	Fiyat (₺)		
<b>KROŞE VE KLİPSLER</b>						
062 129 132020	20x20 YAPIŞKANLI KROŞE	100 ad.	25000	1,083		
062 129 132828	28x28 YAPIŞKANLI KROŞE	100 ad.	12500	1,815		
062 129 131316	13x16 YAPIŞKANLI KLİPS	100 ad.	7000	1,143		
062 129 191325	13x25 YAPIŞKANLI KLİPS	100 ad.	5000	1,494		
062 129 132525	25x25 YAPIŞKANLI KLİPS (BEYAZ)	100 ad.	3000	2,33		
062 129 142525	25x25 YAPIŞKANLI KLİPS (SİYAH)	100 ad.	2000	2,503		
062 129 151017	10x17 VİDALI KROŞE	250 ad.	12500	0,835		
062 129 151530	15x30 VİDALI KROŞE	100 ad.	5000	1,404		
062 129 151723	17x23 VİDALI KROŞE	250 ad.	5000	1,21		
062 129 161004	DÜBELLİ KROŞE 6 DELİK İÇİN	500 ad.	15000	0,674		
062 129 171009	DUVAR KROŞESİ 6 DELİK İÇİN	250 ad.	7500	1,176		
033 129 100008	DUVAR KROŞESİ 8 DELİK İÇİN	250 ad.	4000	1,433		
062 129 171011	KANAL KROŞESİ 6 DELİK İÇİN	250 ad.	7500	1,148		
062 129 500003	KABLO KLİPSİ 6,4 (1/4")	100 ad.		0,75		
062 129 500004	KABLO KLİPSİ 7,9 (5/16")	100 ad.		0,854		
062 129 500005	KABLO KLİPSİ 10,9 ( 3/8")	100 ad.		0,901		
<b>KELEPÇELER</b>						
062 129 010101	2x105 BONCUK KELEPÇE	1000 ad.	25000	0,312		
062 129 010102	3,5x165 BONCUK KELEPÇE	500 ad.	8000	0,732		
062 129 500000	3,5x235 BONCUK KELEPÇE	100 ad.	5000	1,161		
060 120 005105	EA.05.105 BURMA KELEPÇE	500 ad.	70000	0,47		
060 120 007107	EA.07.107 BURMA KELEPÇE	500 ad.	60000	0,489		
060 120 010110	EA.10.110 BURMA KELEPÇE	500 ad.	50000	0,607		
060 120 014114	EA.14.114 BURMA KELEPÇE	500 ad.	40000	0,621		
060 120 017117	EA.17.117 BURMA KELEPÇE	500 ad.	25000	0,726		
<b>ETİKETLER</b>						
062 129 111035	10X35 KABLO BAĞI ETİKETİ	100 ad.	4000	1,945		
062 129 112045	20X45 KABLO BAĞI ETİKETİ	100 ad.	1500	3,605		
062 129 121730	17X30 YAPIŞKANLI PANO ETİKETİ	100 ad.	5000	2,268		
062 129 121750	17X50 YAPIŞKANLI PANO ETİKETİ	50 ad.	3000	3,012		
062 129 122075	17X75 YAPIŞKANLI PANO ETİKETİ	25 ad.	1500	4,127		
<b>HELEZON PANO SİRALİ</b>						
		İç Çap	Dış Çap			
001 020 500001 05 XX	NO.1 PANO SİRALİ (50cm)	5	6	100 ad.	4000	2,10
001 020 500002 05 XX	NO.2 PANO SİRALİ (50cm)	7	8	100 ad.	3000	3,13
001 020 500003 05 XX	NO.3 PANO SİRALİ (50cm)	10	11	100 ad.	2000	3,90
001 020 500004 05 XX	NO.4 PANO SİRALİ (50cm)	13	14	50 ad.	800	7,97
001 020 500005 05 XX	NO.5 PANO SİRALİ (50cm)	16	17	25 ad.	800	8,19
<b>HELEZON PANO SİRALİ (RULO)</b>						
001 020 600001 00 XX	NO.1 PANO SİRALİ (100cm)	5	6	100 mt.	4000	4,39
001 020 600002 00 XX	NO.2 PANO SİRALİ (100cm)	7	8	100 mt.	3000	5,83
001 020 600003 00 XX	NO.3 PANO SİRALİ (100cm)	10	11	100 mt.	2000	7,80
001 020 600004 00 XX	NO.4 PANO SİRALİ (100cm)	13	14	50 mt.	800	15,95
001 020 600005 00 XX	NO.5 PANO SİRALİ (100cm)	16	17	50 mt.	800	16,38

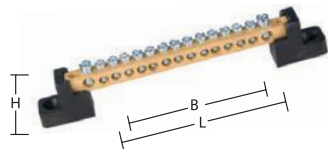
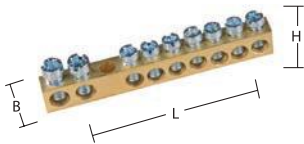

### RAY KLEMENSLER - VİDALI

CE

Ürün Kodu	Ürün Adı	Kutu Adet	Fiyat (₺)
010 094 000025	2,5 mm RAY KLEMENSİ	100	16,70
010 094 000004	4 mm RAY KLEMENSİ	100	17,89
010 094 000006	6 mm RAY KLEMENSİ	100	28,63
010 094 000010	10 mm RAY KLEMENSİ	100	35,78
010 094 000016	16 mm RAY KLEMENSİ	30	59,64
010 094 000035	35 mm RAY KLEMENSİ	20	106,75
010 094 010001	KLEMENS DURDURUCU	100	16,16

### RAY KLEMENSLER - TOPRAKLAMALI

CE

Ürün Kodu	Ürün Adı	Kutu Adet	Fiyat (₺)
010 094 010003	2.5 mm TOPRAKLAMALI RAY KLEMENSİ	100	65,06
010 094 010008	4 mm TOPRAKLAMALI RAY KLEMENSİ	100	74,54
010 094 010004	6 mm TOPRAKLAMALI RAY KLEMENSİ	100	105,49
010 094 010009	10 mm TOPRAKLAMALI RAY KLEMENSİ	100	110,24
010 094 010005	16 mm TOPRAKLAMALI RAY KLEMENSİ	30	171,68
010 094 010010	35 mm TOPRAKLAMALI RAY KLEMENSİ	20	230,19

### YAY BASKILI RAY KLEMENSLER

CE

Ürün Kodu	Ürün Adı	Kutu Adet	Fiyat (₺)
010 094 010011	2,5 mm RAY KLEMENSİ (YAY BASKILI)	100	19,08
010 094 010012	4 mm RAY KLEMENSİ (YAY BASKILI)	100	25,64
010 094 010013	6 mm RAY KLEMENSİ (YAY BASKILI)	100	47,71
010 094 010014	10 mm RAY KLEMENSİ (YAY BASKILI)	100	53,08

### SİGORTALI RAY KLEMENSLER

CE

Ürün Kodu	Ürün Adı	Kutu Adet	Fiyat (₺)
010 094 000051	SİGORTALI RAY KLEMENS	75	122,25

### DEKAFİX

Ürün Kodu	Ürün Adı	Kutu Adet	Fiyat (₺)
010 094 010006	YAZILI DEKAFİX (1 ADET FİYATI)	500	1,21
010 094 010007	YAZISIZ DEKAFİX (1 ADET FİYATI)	500	0,93

### PANO TOPRAKLAMA KLEMENSLERİ (6x8 mm) 63A

Ürün Kodu	Ürün Adı	L	B	H	Kutu Adet	Fiyat (₺)
014 102 006304	4 DELİK PANO TOPRAKLAMA KLEMENS	6	8	33	1500	27,11
014 102 006305	5 DELİK PANO TOPRAKLAMA KLEMENS	6	8	38	1500	29,82
014 102 006306	6 DELİK PANO TOPRAKLAMA KLEMENS	6	8	45	1250	37,95
014 102 006307	7 DELİK PANO TOPRAKLAMA KLEMENS	6	8	50	1000	40,66
014 102 006309	9 DELİK PANO TOPRAKLAMA KLEMENS	6	8	62	1000	46,08
014 102 006310	10 DELİK PANO TOPRAKLAMA KLEMENS	6	8	68	750	56,93
014 102 006312	12 DELİK PANO TOPRAKLAMA KLEMENS	6	8	80	750	67,77

### PANO TOPRAKLAMA KLEMENSLERİ AYAKLI (6,5X9 mm) 80A

Ürün Kodu	Ürün Adı	L	B	H	Kutu Adet	Fiyat (₺)
014 102 008006	6 DELİK AYAKLI DAĞITIM ÜNİTESİ	85	70	22	200	62,23
014 102 008010	10 DELİK AYAKLI DAĞITIM ÜNİTESİ	108	95	22	150	82,97
014 102 008012	12 DELİK AYAKLI DAĞITIM ÜNİTESİ	120	106	22	150	87,12
014 102 008015	15 DELİK AYAKLI DAĞITIM ÜNİTESİ	138	124	22	125	106,31
014 102 008020	20 DELİK AYAKLI DAĞITIM ÜNİTESİ	165	152	22	100	140,01

### 1 KUTUP DAĞITIM ÜNİTESİ 125A

Ürün Kodu	Ürün Adı	Cinsi	L	B	H	Koli Adet	Fiyat (₺)
014 102 112507	125 A. 1 KUTUP DAĞITIM ÜNİTESİ	2+5	76	44	42	70	140,01
014 102 112510	125 A. 1 KUTUP DAĞITIM ÜNİTESİ	2+8	100	44	42	60	163,35
014 102 112512	125 A. 1 KUTUP DAĞITIM ÜNİTESİ	2+10	115	44	42	55	189,28
014 102 112515	125 A. 1 KUTUP DAĞITIM ÜNİTESİ	2+13	135	44	42	45	239,84
014 102 112520	125 A. 1 KUTUP DAĞITIM ÜNİTESİ	2+18	170	44	42	35	298,18
014 102 112522	125 A. 1 KUTUP DAĞITIM ÜNİTESİ	2+20	185	44	42	30	329,29

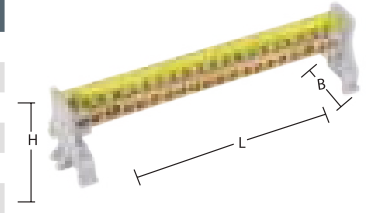

### 2 KUTUP DAĞITIM ÜNİTESİ 125A

Ürün Kodu	Ürün Adı	Cinsi	L	B	H	Koli Adet	Fiyat (₺)
014 102 212507	125 A. 2 KUTUP DAĞITIM ÜNİTESİ	2+5	81	90	50	20	285,21
014 102 212510	125 A. 2 KUTUP DAĞITIM ÜNİTESİ	2+8	103	90	50	16	311,14
014 102 212512	125 A. 2 KUTUP DAĞITIM ÜNİTESİ	2+10	118	90	50	12	342,26
014 102 212515	125 A. 2 KUTUP DAĞITIM ÜNİTESİ	2+13	142	90	50	10	440,79
014 102 212520	125 A. 2 KUTUP DAĞITIM ÜNİTESİ	2+18	178	90	50	8	560,06

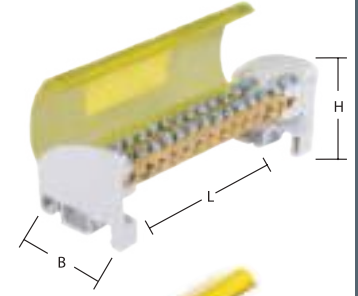

### 4 KUTUP DAĞITIM ÜNİTESİ 125A

Ürün Kodu	Ürün Adı	Cinsi	L	B	H	Koli Adet	Fiyat (₺)
014 102 412507	125 A. 4 KUTUP DAĞITIM ÜNİTESİ	2+5	60	80	75	10	544,50
014 102 412510	125 A. 4 KUTUP DAĞITIM ÜNİTESİ	2+8	83	80	75	8	596,36
014 102 412512	125 A. 4 KUTUP DAĞITIM ÜNİTESİ	2+10	97	80	75	6	653,40
014 102 412515	125 A. 4 KUTUP DAĞITIM ÜNİTESİ	2+13	120	80	75	5	808,97
014 102 412520	125 A. 4 KUTUP DAĞITIM ÜNİTESİ	2+18	155	80	75	4	1.052,70
014 102 412522	125 A. 4 KUTUP DAĞITIM ÜNİTESİ	2+20	170	80	75	4	1.120,11
014 102 412525	125 A. 4 KUTUP DAĞITIM ÜNİTESİ	2+23	191	80	75	4	1.296,43

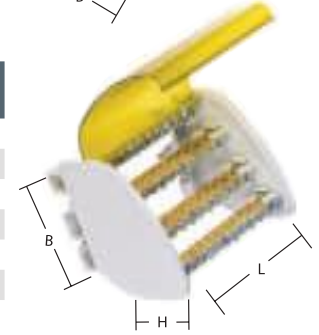

**GEÇMELİ ve  
TIRNAK TİP  
BUAT  
KLEMENSLER**

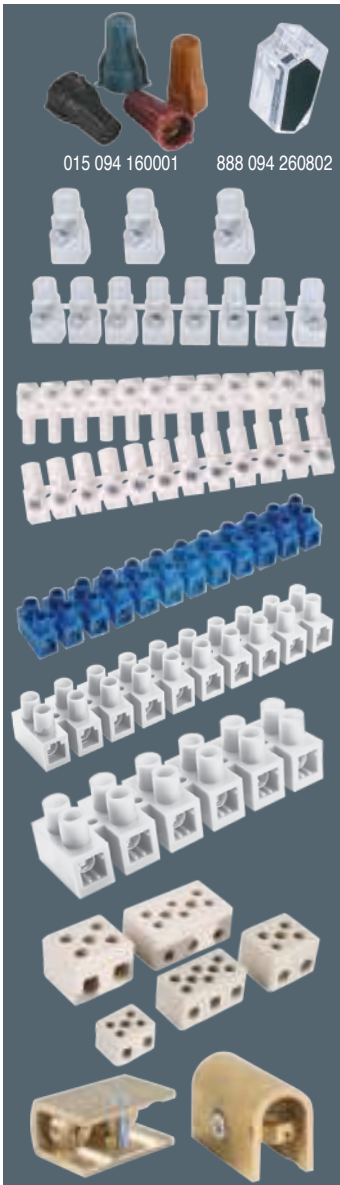

Ürün Kodu	Ürün Adı	Kutu Adet	Koli Adet	Fiyat (₺)
<b>SWISS GEÇMELİ BUAT KLEMENS</b>				
999 094 225000	2'Lİ GEÇMELİ BUAT KLEMENS (0,5-4 mm <sup>2</sup> )	100	6000	0,149 \$
999 094 325000	3'LÜ GEÇMELİ BUAT KLEMENS (0,5-4 mm <sup>2</sup> )	100	6000	0,264 \$
999 094 425000	4'LÜ GEÇMELİ BUAT KLEMENS (0,5-4 mm <sup>2</sup> )	100	6000	0,304 \$
999 094 525000	5'Lİ GEÇMELİ BUAT KLEMENS (0,5-4 mm <sup>2</sup> )	100	6000	0,329 \$
<b>SWISS TIRNAKLI BUAT KLEMENS</b>				
999 094 241000	2'Lİ TIRNAKLI BUAT KLEMENS (0,5-2,5 mm <sup>2</sup> )	100	2400	0,464 \$
999 094 341000	3'LÜ TIRNAKLI BUAT KLEMENS (0,5-2,5 mm <sup>2</sup> )	100	2400	0,606 \$
999 094 541000	5'Lİ TIRNAKLI BUAT KLEMENS (0,5-2,5 mm <sup>2</sup> )	50	1200	0,959 \$
<b>GEÇMELİ BUAT KLEMENSLERİ</b>				
888 094 260802	BM802 GEÇMELİ BUAT KLEMENSİ (2'Lİ)	400	6400	0,149 \$
015 094 160001	NO. 2 ZEYTİN (BUAT) KLEMENS	1000		1,807
<b>ŞEFFAF ISIYA DAYANIKLI BUAT KLEMENSLER</b>				
888 094 000105	NO.2 ŞEFFAF BUAT KLEMENS (1 ADET FİYAT)		560	4,95
888 094 000205	NO.3 ŞEFFAF BUAT KLEMENS (1 ADET FİYAT)		360	7,00
888 094 000405	NO.4 ŞEFFAF BUAT KLEMENS (1 ADET FİYAT)		200	11,52
888 094 000605	NO.5 ŞEFFAF BUAT KLEMENS (1 ADET FİYAT)		120	15,59
<b>GEÇMELİ SOKET KLEMENSLER</b>				
999 999 991212	12'Lİ GEÇMELİ SOKET KLEMENS	25	500	144,12
<b>PLASTİK SIRA KLEMENSLER</b>				
015 094 150001	NO. 1 SIRA KLEMENSLER (2,5-4 mm <sup>2</sup> )	50	1000	40,43
015 094 150002	NO. 2 SIRA KLEMENSLER (4-6 mm <sup>2</sup> )	50	800	51,28
015 094 150003	NO. 3 SIRA KLEMENSLER (6-10 mm <sup>2</sup> )	50	400	66,19
015 094 150004	NO. 4 SIRA KLEMENSLER (10-16 mm <sup>2</sup> )	50	400	72,51
015 094 150005	NO. 5 SIRA KLEMENSLER (16-25 mm <sup>2</sup> )	50	400	78,84
<b>ISIYA DAYANIKLI SIRA KLEMENSLER</b> <span style="float: right;">CE</span>				
015 094 170001	NO. 1 ISIYA DAYANIKLI KLEMENSLER (2,5-4 mm <sup>2</sup> )	50	1000	42,24
015 094 170002	NO. 2 ISIYA DAYANIKLI KLEMENSLER (4-6 mm <sup>2</sup> )	50	800	53,99
015 094 170003	NO. 3 ISIYA DAYANIKLI KLEMENSLER (6-10 mm <sup>2</sup> )	50	400	70,25
015 094 170004	NO. 4 ISIYA DAYANIKLI KLEMENSLER (10-16 mm <sup>2</sup> )	50	400	76,58
015 094 170005	NO. 5 ISIYA DAYANIKLI KLEMENSLER (16-25 mm <sup>2</sup> )	50	400	83,81
<b>PORSELEN KLEMENSLER</b> <span style="float: right;">CE</span>				
015 094 180002	NO. 1-2'Lİ PORSELEN KLEMENS (2,5-4 mm <sup>2</sup> )	396		14,03
015 094 180003	NO. 1-3'LÜ PORSELEN KLEMENS (2,5-4 mm <sup>2</sup> )	220		17,33
015 094 180004	NO. 2-2'Lİ PORSELEN KLEMENS (4-6 mm <sup>2</sup> )	200		17,33
015 094 180005	NO. 2-3'LÜ PORSELEN KLEMENS (4-6 mm <sup>2</sup> )	150		24,75
015 094 180006	NO. 3-2'Lİ PORSELEN KLEMENS (6-10 mm <sup>2</sup> )	104		24,75
015 094 180007	NO. 3-3'LÜ PORSELEN KLEMENS (6-10 mm <sup>2</sup> )	64		31,35
<b>U KLEMENSLER</b>				
014 094 030006	6'LİK U KLEMENS	300		22,73
014 094 030010	10'LÜK U KLEMENS	250		33,76
014 094 030016	16'LİK U KLEMENS	100		45,19
014 094 030025	25'LİK U KLEMENS	100		51,82
014 094 030035	35'LİK U KLEMENS	75		63,53
014 094 030050	50'LİK U KLEMENS	50		99,83
014 094 030070	70'LİK U KLEMENS	40		137,26
014 094 030095	95'LİK U KLEMENS	25		166,07
014 094 030120	120'LİK U KLEMENS	20		221,20
014 094 030150	150'LİK U KLEMENS	15		294,94

Ürün Kodu	Ürün Adı	Kutu Adet	Koli Adet	Fiyat (₺)
<b>İZOLELİ TEK GİRİŞLİ YÜKSÜK</b>				
014 100 010508	ITY-0508 İZO.TEK GİRİŞ. YÜKSÜK 0,50 mm	1000		0,376
014 100 017508	ITY-7508 İZO.TEK GİRİŞ. YÜKSÜK 0,75 mm	1000		0,376
014 100 011008	ITY-1008 İZO.TEK GİRİŞ. YÜKSÜK 1,00 mm	1000		0,376
014 100 011508	ITY-1508 İZO.TEK GİRİŞ. YÜKSÜK 1,50 mm	1000		0,415
014 100 012508	ITY-2508 İZO.TEK GİRİŞ. YÜKSÜK 2,50 mm	500		0,541
014 100 014009	ITY-4009 İZO.TEK GİRİŞ. YÜKSÜK 4,00 mm	500		0,901
014 100 016012	ITY-6012 İZO.TEK GİRİŞ. YÜKSÜK 6,00 mm	250		1,215
014 100 011012	ITY-1012 İZO.TEK GİRİŞ. YÜKSÜK 10,00 mm	100		1,544
014 100 011612	ITY-1612 İZO.TEK GİRİŞ. YÜKSÜK 16,00 mm	100		2,147
014 100 012516	ITY-2516 İZO.TEK GİRİŞ. YÜKSÜK 25,00 mm	50		3,605
014 100 013516	ITY-3516 İZO.TEK GİRİŞ. YÜKSÜK 35,00 mm	40		4,467
014 100 015020	ITY-5020 İZO.TEK GİRİŞ. YÜKSÜK 50,00 mm	25		8,465
<b>İZOLELİ ÇİFT GİRİŞLİ YÜKSÜK</b>				
014 100 020508	ICY-0508 İZO.ÇİFT GİRİŞ. YÜKSÜK 2x0,5 mm	1000		0,674
014 100 027508	ICY-7508 İZO.ÇİFT GİRİŞ. YÜKSÜK 2x0,75 mm	500		0,721
014 100 021008	ICY-1008 İZO.ÇİFT GİRİŞ. YÜKSÜK 2x1 mm	500		0,768
014 100 021508	ICY-1508 İZO.ÇİFT GİRİŞ. YÜKSÜK 2x1,5 mm	500		0,925
014 100 022510	ICY-2510 İZO.ÇİFT GİRİŞ. YÜKSÜK 2x2,5 mm	250		1,489
014 100 024012	ICY-4012 İZO.ÇİFT GİRİŞ. YÜKSÜK 2x4 mm	200		1,724
014 100 026014	ICY-6014 İZO.ÇİFT GİRİŞ. YÜKSÜK 2x6 mm	100		2,147
<b>İZOLELİ YUVARLAK TİP PABUÇ</b>				
014 100 030154	IYP-1,5-4 İZO.YUV.TİP PAB. 0,5-1,5 mm(M4)	200		1,85
014 100 030155	IYP-1,5-5 İZO.YUV.TİP PAB. 0,5-1,5 mm(M5)	200		1,865
014 100 030156	IYP-1,5-6 İZO.YUV.TİP PAB. 0,5-1,5 mm(M6)	200		2,978
014 100 030158	IYP-1,5-8 İZO.YUV.TİP PAB. 0,5-1,5 mm(M8)	200		2,978
014 100 030254	IYP-2,5-4 İZO.YUV.TİP PAB. 1,5-2,5 mm(M4)	200		2,273
014 100 030255	IYP-2,5-5 İZO.YUV.TİP PAB. 1,5-2,5 mm(M5)	200		2,304
014 100 030256	IYP-2,5-6 İZO.YUV.TİP PAB. 1,5-2,5 mm(M6)	200		3,292
014 100 030258	IYP-2,5-8 İZO.YUV.TİP PAB. 1,5-2,5 mm(M8)	200		3,292
014 100 036004	IYP-6-4 İZO.YUV.TİP PAB. 4-6 mm(M4)	100		4,859
014 100 036005	IYP-6-5 İZO.YUV.TİP PAB. 4-6 mm(M5)	100		4,859
014 100 036006	IYP-6-6 İZO.YUV.TİP PAB. 4-6 mm(M6)	100		5,486
014 100 036008	IYP-6-8 İZO.YUV.TİP PAB. 4-6 mm(M8)	100		7,054
<b>İZOLELİ ÇATAL TİP PABUÇ</b>				
014 100 040154	ICP-1,5-4 İZO.ÇTL.TİP PAB. 0,5-1,5 mm(M4)	200		1,724
014 100 040155	ICP-1,5-5 İZO.ÇTL.TİP PAB. 0,5-1,5 mm(M5)	200		1,803
014 100 040156	ICP-1,5-6 İZO.ÇTL.TİP PAB. 0,5-1,5 mm(M6)	200		2,038
014 100 040254	ICP-2,5-4 İZO.ÇTL.TİP PAB.1,5-2,5 MM(M4)	200		1,928
014 100 040255	ICP-2,5-5 İZO.ÇTL.TİP PAB.1,5-2,5 MM(M5)	200		1,959
014 100 040256	ICP-2,5-6 İZO.ÇTL.TİP PAB.1,5-2,5 MM(M6)	200		2,586
014 100 046004	ICP-6-4 İZO.ÇTL.TİP PAB. 4-6 mm(M4)	100		4,232
014 100 046005	ICP-6-5 İZO.ÇTL.TİP PAB. 4-6 mm(M5)	100		4,311
014 100 046006	ICP-6-6 İZO.ÇTL.TİP PAB. 4-6 mm(M6)	100		5,721
<b>İZOLELİ İĞNE TİP TERMİNAL</b>				
014 100 050015	IIT-1,5 İZOLELİ İĞNE TİP TERM.0,5-1,5 mm	200		1,959
014 100 050025	IIT-2,5 İZOLELİ İĞNE TİP TERM.1,5-2,5 mm	200		2,351
014 100 050040	IIT-4 İZOLELİ İĞNE TİP TERM.4-6 mm	100		5,643
<b>İZOLELİ EK MUF</b>				
014 100 070015	IEM-1,5 İZOLELİ EK MUF 0,5-1,5 mm	200		2,586
014 100 070025	IEM-2,5 İZOLELİ EK MUF 1,5-2,5 mm	200		2,618
014 100 070040	IEM-4 İZOLELİ EK MUF 4-6 mm	100		4,389
<b>İZOLELİ FASTON ERKEK TERMİNAL</b>				
014 100 060015	IFE-1,5 İZO. FASTON ERK. TERM. 1,5 mm	200		1,831
014 100 060025	IFE-2,5 İZO. FASTON ERK. TERM. 2,5 mm	200		1,919
014 100 060040	IFE-4 İZO. FASTON ERK. TERM. 4 mm	200		2,274
<b>İZOLELİ FASTON DIŞI TERMİNAL</b>				
014 100 080510	IDT-0,5-1 YARIM İZO. DIŞI TERM.0,5-1MM	100		1,948
014 100 081525	IDT-1,5-2,5 YARIM İZO. DIŞI TERM.1,5-2,5MM	100		1,979
014 100 084060	IDT-4-6 YARIM İZO. DIŞI TERM.4-6 MM	100		2,285
<b>TAM İZOLELİ DIŞI TERMİNAL</b>				
014 100 090510	TDT-0,5-1 TAM İZO.DIŞI TERM. 0,5-1 mm	100		2,667
014 100 091525	TDT-1,5-2,5 TAM İZO.DIŞI TERM.1,5-2,5 mm	100		2,778
014 100 094060	TDT-4-6 TAM İZO.DIŞI TERM. 4-6 mm	100		3,189
<b>YUVARLAK DIŞI TERMİNAL</b>				
014 100 100510	YDT-0,5-1 YUV. DIŞI TERM. 0,5-1 mm	200		5,251
014 100 101525	YDT-1,5-2,5 YUV. DIŞI TERM. 1,5-2,5 mm	100		5,878
014 100 104060	YDT-4-6 YUV. DIŞI TERM. 4-6 mm	100		7,367
<b>YUVARLAK ERKEK TERMİNAL</b>				
014 100 110510	YET-0,5-1 YUV. ERKEK TERM. 0,5-1 mm	200		4,389
014 100 111525	YET-1,5-2,5 YUV. ERKEK TERM.1,5-2,5 mm	200		4,938
014 100 114060	YET-4-6 YUV. ERKEK TERM. 4-6 mm	200		6,662
<b>FASTON TİP TERMİNALLER İZOLESİZ</b>				
065 100 140003	TSF-1-D 6,3 FASTON TİP TERMİNAL	300		1,609
065 100 140002	TSF-1-D MİNİ 4,8 FASTON TİP TERMİNAL	500		1,248
065 100 140004	TSF-1-E FASTON TİP TERMİNAL	300		1,642



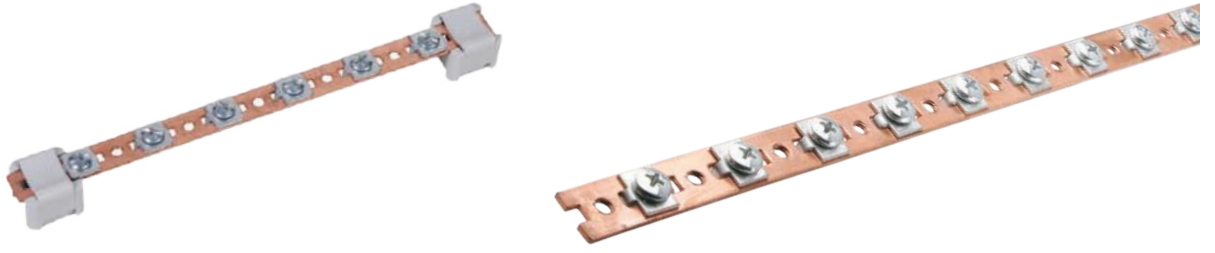

### TOPRAKLAMA BARASI VE MESNEDİ

Ürün Kodu	Ürün Adı	Adet	Fiyat (₺)
034 025 040000	TOPRAKLAMA BARASI 1,5 mm (31 VİDA)	40	648,21
034 025 100001	TOPRAKLAMA BARASI MESNEDİ	100	7,35

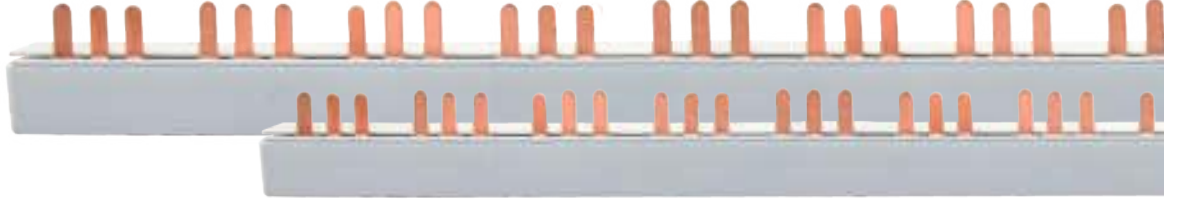

### TRİFAZE BARALAR

Ürün Kodu	Ürün Adı	Adet	Fiyat (₺)
034 025 040004	TRİFAZE MÜŞTEREK BARA İĞNE UÇLU 80A - 53 cm	24	537,47
034 025 040005	TRİFAZE MÜŞTEREK BARA İĞNE UÇLU 63A - 53 cm	24	482,68
034 025 040006	TRİFAZE MÜŞTEREK BARA İĞNE UÇLU 80A - 106 cm	24	1.074,93
034 025 040007	TRİFAZE MÜŞTEREK BARA İĞNE UÇLU 63A - 106 cm	24	965,35



### MONOFAZE BARALAR

Ürün Kodu	Ürün Adı	Adet	Fiyat (₺)
034 025 040002	MONOFAZE MÜŞTEREK BARA İĞNE UÇLU 106 cm	50	432,14
034 025 040003	MONOFAZE MÜŞTEREK BARA İĞNE UÇLU 53 cm	50	225,89

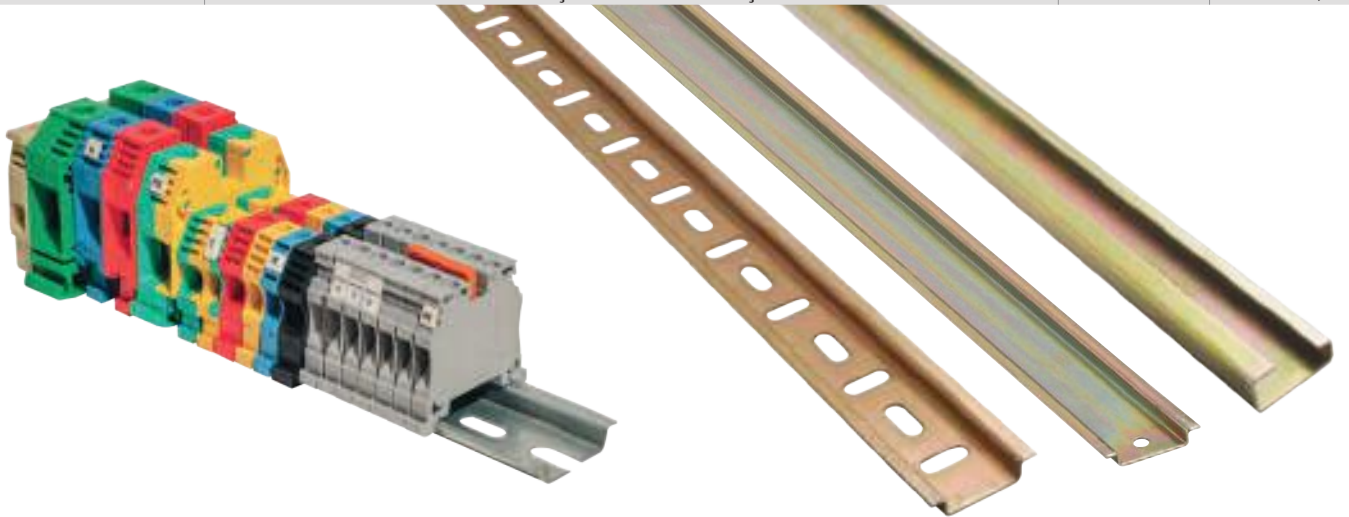

### RAYLAR

Ürün Kodu	Ürün Adı	Adet	Fiyat (₺)
001 025 020100 00 00	KLEMENS RAYI(1mt.)	25 mt.	151,40
001 025 000100 00 00	W OTOMAT RAYI(1M) (1mt. Fiyatı)	50 mt.	76,72
001 025 000200 00 00	W OTOMAT RAYI(2M) (1mt. Fiyatı)	50 mt.	76,72
001 025 000033 00 00	W OTOMAT RAYI (33 cm)	CE 50 mt.	26,26
001 025 900100 00 00	W OTOMAT RAYI(DELİKLİ)(1M)(1mt Fiyatı)	CE 50 mt.	83,66
001 025 900200 00 00	W OTOMAT RAYI(DELİKLİ)(2M)(1mt Fiyatı)	CE 50 mt.	83,66

## EKO KABLO PABUÇLARI

Ürün Kodu	Ürün Adı	Çivata	D3	D2	D1	L	A	Kutu Adet	Fiyat (₺)
123 037 000016	16-06 EKO TİP KABLO PABUCU	M6	6,5	5,8	7,4	30	12	500	11,22
123 037 000025	25-08 EKO TİP KABLO PABUCU	M8	8,5	7	9,2	40	14	350	19,83
123 037 000035	35-08 EKO TİP KABLO PABUCU	M8	8,5	8,2	10,7	44	15,3	200	26,09
123 037 000050	50-10 EKO TİP KABLO PABUCU	M10	10,5	10,2	12,8	52	20	150	31,31
123 037 000070	70-10 EKO TİP KABLO PABUCU	M10	10,5	11,7	14,7	55	22	100	52,18
123 037 000095	95-12 EKO TİP KABLO PABUCU	M12	13	13,6	16,7	59	26	70	60,28
123 037 000120	120-12 EKO TİP KABLO PABUCU	M12	13	15,5	19	70	29	50	83,30
123 037 000150	150-12 EKO TİP KABLO PABUCU	M12	13	16,7	21	77	32	40	136,67
123 037 000185	185-16 EKO TİP KABLO PABUCU	M16	17	18,8	23	85	35	30	157,84
123 037 000240	240-16 EKO TİP KABLO PABUCU	M16	17	21,2	26	90	38,5	24	245,25

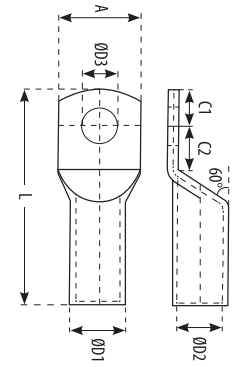

## STANDART KABLO PABUÇLARI

Ürün Kodu	Ürün Adı	Çivata	D3	D2	D1	L	A	Kutu Adet	Fiyat (₺)
123 037 500010	10-05 STANDART TİP KABLO PABUCU	M5	5,2	4,7	6,5	27,5	10,5	800	11,48
123 037 500011	10-06 STANDART TİP KABLO PABUCU	M6	6,5	4,7	6,5	27,5	10,5	800	11,48
123 037 500012	10-08 STANDART TİP KABLO PABUCU	M8	8,5	4,7	6,5	27,5	10,5	800	11,78
123 037 500016	16-06 STANDART TİP KABLO PABUCU	M6	6,5	5,8	7,4	30	12	500	16,96
123 037 500017	16-08 STANDART TİP KABLO PABUCU	M8	8,5	5,8	7,8	30	12	500	17,22
123 037 500018	16-10 STANDART TİP KABLO PABUCU	M10	10,5	5,8	7,8	30	12	500	17,22
123 037 500024	25-06 STANDART TİP KABLO PABUCU	M6	6,5	7	9,2	40	14	350	27,92
123 037 500025	25-08 STANDART TİP KABLO PABUCU	M8	8,5	7	9,2	40	14	350	28,18
123 037 500026	25-10 STANDART TİP KABLO PABUCU	M10	10,5	7	9,5	40	14	350	28,44
123 037 500034	35-06 STANDART TİP KABLO PABUCU	M6	6,5	8,2	10,7	44	15,3	200	37,31
123 037 500035	35-08 STANDART TİP KABLO PABUCU	M8	8,5	8,2	10,7	44	15,3	200	37,57
123 037 500036	35-10 STANDART TİP KABLO PABUCU	M10	10,5	8,2	10,7	44	15,3	200	37,83
123 037 500037	35-12 STANDART TİP KABLO PABUCU	M12	13	8,2	10,7	44	15,3	200	38,57
123 037 500049	50-08 STANDART TİP KABLO PABUCU	M8	8,5	10,2	12,8	52	20	150	57,15
123 037 500050	50-10 STANDART TİP KABLO PABUCU	M10	10,5	10,2	12,8	52	20	150	56,36
123 037 500051	50-12 STANDART TİP KABLO PABUCU	M12	13	10,2	12,8	52	20	150	56,62
123 037 500069	70-08 STANDART TİP KABLO PABUCU	M8	8,5	11,7	14,7	55	22	100	75,84
123 037 500070	70-10 STANDART TİP KABLO PABUCU	M10	10,5	11,7	14,7	55	22	100	70,71
123 037 500071	70-12 STANDART TİP KABLO PABUCU	M12	13	11,7	14,7	55	22	100	72,71
123 037 500094	95-10 STANDART TİP KABLO PABUCU	M10	10,5	13,6	16,7	59	26	70	88,71
123 037 500095	95-12 STANDART TİP KABLO PABUCU	M12	13	13,6	16,7	59	26	70	88,97
123 037 500119	120-10 STANDART TİP KABLO PABUCU	M10	10,5	15,5	19	70	29	50	120,57
123 037 500120	120-12 STANDART TİP KABLO PABUCU	M12	13	15,5	19	70	29	50	120,28
123 037 500149	150-10 STANDART TİP KABLO PABUCU	M10	10,5	16,7	21	77	32	40	195,68
123 037 500150	150-12 STANDART TİP KABLO PABUCU	M12	13	16,7	21	77	32	40	196,20
123 037 500183	185-10 STANDART TİP KABLO PABUCU	M10	10,5	18,8	23	85	35	30	234,82
123 037 500184	185-12 STANDART TİP KABLO PABUCU	M12	13	18,8	23	85	35	30	234,82
123 037 500185	185-16 STANDART TİP KABLO PABUCU	M16	17	18,8	23	85	35	30	234,82
123 037 500238	240-10 STANDART TİP KABLO PABUCU	M10	10,5	21,2	26	90	38,5	24	319,61
123 037 500239	240-12 STANDART TİP KABLO PABUCU	M12	13	21,2	26	90	38,5	24	319,61
123 037 500240	240-16 STANDART TİP KABLO PABUCU	M16	17	21,2	26	90	38,5	24	319,61
123 037 500299	300-12 STANDART TİP KABLO PABUCU	M12	13	23,5	28,6	100	43	20	443,54
123 037 500300	300-16 STANDART TİP KABLO PABUCU	M16	17	23,5	28,6	100	43	20	443,54



## BORU TİP SIKMALI EK MUFLAR

Ürün Kodu	Ürün Adı	D2	D3	L	Kutu Adet	Fiyat (₺)
123 037 300016	16 mm² BORU TİP SIKMALI EK MUF	5,8	7,4	30	500	13,83
123 037 300025	25 mm² BORU TİP SIKMALI EK MUF	7,2	9,2	40	300	22,44
123 037 300035	35 mm² BORU TİP SIKMALI EK MUF	8,5	11	44	200	28,70
123 037 300050	50 mm² BORU TİP SIKMALI EK MUF	10	13	52	150	36,53
123 037 300070	70 mm² BORU TİP SIKMALI EK MUF	11,5	14,7	55	100	57,40
123 037 300095	95 mm² BORU TİP SIKMALI EK MUF	13,5	16,7	59	70	67,84
123 037 300120	120 mm² BORU TİP SIKMALI EK MUF	15,6	19	70	50	93,23
123 037 300150	150 mm² BORU TİP SIKMALI EK MUF	17	21	77	40	147,41
123 037 300185	185 mm² BORU TİP SIKMALI EK MUF	19	23	85	30	173,94
123 037 300240	240 mm² BORU TİP SIKMALI EK MUF	21	26	90	24	269,78





## MUTLUSAN SANAYİ TİPİ FİŞ - PRİZ GRUBU (MONOFAZE 1x16A)



ÜRÜN KODU	010 083 300027
ÜRÜN ADI	MUT-27 1x16 A MONO. TOP. ERKEK FİŞ (EĞİK)
ADET/KOLİ	40/320
FİYAT (₺)	46,53



ÜRÜN KODU	010 083 300028
ÜRÜN ADI	MUT-28 1x16 A MONO. TOP. ERKEK FİŞ (DÜZ)
ADET/KOLİ	40/320
FİYAT (₺)	46,53



ÜRÜN KODU	010 083 300029
ÜRÜN ADI	MUT-29 1x16 A MONO. TOP. DİŞİ FİŞ
ADET/KOLİ	25/200
FİYAT (₺)	81,10



ÜRÜN KODU	010 083 500296
ÜRÜN ADI	MUT-29/6 1x16 A MONO. TOP. DUVAR PRİZ
ADET/KOLİ	20/150
FİYAT (₺)	101,97



ÜRÜN KODU	010 083 500293
ÜRÜN ADI	MUT-29/3 1x16 A MONO. 3'LÜ GRUP PRİZ
ADET/KOLİ	12/96
FİYAT (₺)	164,90



ÜRÜN KODU	010 083 500294
ÜRÜN ADI	MUT-29/4 1x16 A MONO. 4'LÜ GRUP PRİZ
ADET/KOLİ	10/80
FİYAT (₺)	208,73



ÜRÜN KODU	010 083 501292
ÜRÜN ADI	MUT-29/2A 1x16 A MONO. 2'Lİ GRUP PRİZ ANAHTARLI
ADET/KOLİ	12/96
FİYAT (₺)	292,22



ÜRÜN KODU	010 083 501293
ÜRÜN ADI	MUT-29/3A 1x16 A MONO. 3'LÜ GRUP PRİZ ANAHTARLI
ADET/KOLİ	10/80
FİYAT (₺)	350,59



ÜRÜN KODU	010 083 500292
ÜRÜN ADI	MUT-29/2 1x16 A MONO. 2'Lİ GRUP PRİZ
ADET/KOLİ	14/112
FİYAT (₺)	127,63

## MUTLUSAN SANAYİ TİPİ FİŞ - PRİZ GRUBU (TRİFAZE 3x25A)



ÜRÜN KODU	010 083 400030
ÜRÜN ADI	MUT-30 3x25 A TRİFAZE ERKEK FİŞ
ADET/KOLİ	25/200
FİYAT (₺)	102,10



ÜRÜN KODU	010 083 400031
ÜRÜN ADI	MUT-31 3x25 A TRİFAZE DİŞİ FİŞ (SEYYAR)
ADET/KOLİ	20/160
FİYAT (₺)	161,02



ÜRÜN KODU	010 083 600315
ÜRÜN ADI	MUT-31/5 3x25 A TRİFAZE DUVAR PRİZİ
ADET/KOLİ	20/160
FİYAT (₺)	190,83



ÜRÜN KODU	010 083 600311
ÜRÜN ADI	MUT-31/1 1 TRİFAZE + 1 MONOFAZE GR. PRİZ
ADET/KOLİ	10/80
FİYAT (₺)	346,78



ÜRÜN KODU	010 083 600312
ÜRÜN ADI	MUT-31/2 TRİFAZE GRUP PRİZ -2'Lİ
ADET/KOLİ	10/80
FİYAT (₺)	384,02



ÜRÜN KODU	010 083 600313
ÜRÜN ADI	MUT-31/3 TRİFAZE GRUP PRİZ -3'LÜ
ADET/KOLİ	10/80
FİYAT (₺)	437,78



ÜRÜN KODU	010 083 600316
ÜRÜN ADI	MUT-31/6 2 TRİFAZE + 1 MONOFAZE GR. PRİZ
ADET/KOLİ	10/80
FİYAT (₺)	437,78



ÜRÜN KODU	010 083 600317
ÜRÜN ADI	MUT-31/7 1 TRİFAZE + 2 MONOFAZE GR. PRİZ
ADET/KOLİ	10/80
FİYAT (₺)	437,78

## MUTLUSAN SANAYİ TİPİ FİŞ - PRİZ GRUBU (TRİFAZE 3x16A)

CE



ÜRÜN KODU	010 083 400060
ÜRÜN ADI	MUT-60 3x16 A TRİFAZE ERKEK FİŞ
ADET/KOLİ	30/240
FİYAT (₺)	178,91

CE



ÜRÜN KODU	010 083 400061
ÜRÜN ADI	MUT-61 3x16 A TRİFAZE SEYYAR DIŞI FİŞ
ADET/KOLİ	25/200
FİYAT (₺)	218,86

CE



ÜRÜN KODU	010 083 400062
ÜRÜN ADI	MUT-62 3x16 A TRİFAZE DUVAR PRİZİ
ADET/KOLİ	20/160
FİYAT (₺)	274,32

## MUTLUSAN SANAYİ TİPİ FİŞ - PRİZ GRUBU (TRİFAZE 3x32A)

CE



ÜRÜN KODU	010 083 400070
ÜRÜN ADI	MUT-70 3x32 A TRİFAZE ERKEK FİŞ
ADET/KOLİ	20/160
FİYAT (₺)	256,43

CE



ÜRÜN KODU	010 083 400071
ÜRÜN ADI	MUT-71 3x32 A TRİFAZE SEYYAR DIŞI FİŞ
ADET/KOLİ	15/120
FİYAT (₺)	292,22

CE



ÜRÜN KODU	010 083 400072
ÜRÜN ADI	MUT-72 3x32 A TRİFAZE DUVAR PRİZİ
ADET/KOLİ	20/160
FİYAT (₺)	384,65



## MUTLUSAN CEE NORM SANAYİ TİPİ FİŞ - PRİZ GRUBU



CEE	ÜRÜN KODU	010 083 000316
	ÜRÜN ADI	MUT-301 CEE NORM 3/16 A DÜZ FİŞ (YENİ ÜRÜN)
	ADET/KOLİ	16/128
	FİYAT (₺)	186,14



CEE	ÜRÜN KODU	010 083 010316
	ÜRÜN ADI	MUT-302 CEE NORM 3/16 UZATMA PRİZ (YENİ ÜRÜN)
	ADET/KOLİ	15/120
	FİYAT (₺)	238,54



CEE	ÜRÜN KODU	010 083 020316
	ÜRÜN ADI	MUT-303 CEE NORM 3/16 MAKİNE PRİZİ (YENİ ÜRÜN)
	ADET/KOLİ	20/160
	FİYAT (₺)	232,67



CEE	ÜRÜN KODU	010 083 030316
	ÜRÜN ADI	MUT-304 CEE NORM 3/16 DUVAR PRİZİ (YENİ ÜRÜN)
	ADET/KOLİ	8/64
	FİYAT (₺)	304,28



CEE	ÜRÜN KODU	010 083 000416
	ÜRÜN ADI	MUT-401 CEE NORM 4/16 A DÜZ FİŞ (YENİ ÜRÜN)
	ADET/KOLİ	16/128
	FİYAT (₺)	195,17



CEE	ÜRÜN KODU	010 083 010416
	ÜRÜN ADI	MUT-402 CEE NORM 4/16 A UZATMA PRİZ (YENİ ÜRÜN)
	ADET/KOLİ	15/120
	FİYAT (₺)	251,19



CEE	ÜRÜN KODU	010 083 020416
	ÜRÜN ADI	MUT-403 CEE NORM 4/16 A MAKİNE PRİZİ (YENİ ÜRÜN)
	ADET/KOLİ	20/160
	FİYAT (₺)	246,22



CEE	ÜRÜN KODU	010 083 030416
	ÜRÜN ADI	MUT-404 CEE NORM 4/16 A DUVAR PRİZİ (YENİ ÜRÜN)
	ADET/KOLİ	8/64
	FİYAT (₺)	325,29



CEE	ÜRÜN KODU	010 083 000516
	ÜRÜN ADI	MUT-101 CEE NORM 5x16 A DÜZ FİŞ
	ADET/KOLİ	16/128
	FİYAT (₺)	224,99



CEE	ÜRÜN KODU	010 083 020516
	ÜRÜN ADI	MUT-103 CEE NORM 5x16 A MAKİNE PRİZİ
	ADET/KOLİ	20/160
	FİYAT (₺)	283,27



CEE	ÜRÜN KODU	010 083 010516
	ÜRÜN ADI	MUT-102 CEE NORM 5x16 A UZATMA PRİZİ
	ADET/KOLİ	15/120
	FİYAT (₺)	288,69



CEE	ÜRÜN KODU	010 083 030516
	ÜRÜN ADI	MUT-104 CEE NORM 5x16 A DUVAR PRİZİ
	ADET/KOLİ	8/64
	FİYAT (₺)	374,08

## MUTLUSAN CEE NORM SANAYİ TİPİ FİŞ - PRİZ GRUBU



CE	ÜRÜN KODU	010 083 000332
	ÜRÜN ADI	MUT-310 CEE NORM 3/32 A DÜZ FİŞ (YENİ ÜRÜN)
	ADET/KOLİ	12/112
	FİYAT (₺)	256,61



CE	ÜRÜN KODU	010 083 010332
	ÜRÜN ADI	MUT-320 CEE NORM 3/32 UZATMA PRİZ (YENİ ÜRÜN)
	ADET/KOLİ	12/96
	FİYAT (₺)	304,28



CE	ÜRÜN KODU	010 083 020332
	ÜRÜN ADI	MUT-330 CEE NORM 3/32 MAKİNE PRİZİ (YENİ ÜRÜN)
	ADET/KOLİ	14/112
	FİYAT (₺)	262,04



CE	ÜRÜN KODU	010 083 030332
	ÜRÜN ADI	MUT-340 CEE NORM 3/32 DUVAR PRİZİ (YENİ ÜRÜN)
	ADET/KOLİ	8/64
	FİYAT (₺)	334,32



CE	ÜRÜN KODU	010 083 000432
	ÜRÜN ADI	MUT-410 CEE NORM 4/32 A DÜZ FİŞ (YENİ ÜRÜN)
	ADET/KOLİ	14/112
	FİYAT (₺)	271,07



CE	ÜRÜN KODU	010 083 010432
	ÜRÜN ADI	MUT-420 CEE NORM 4/32 A UZATMA PRİZ (YENİ ÜRÜN)
	ADET/KOLİ	12/96
	FİYAT (₺)	325,29



CE	ÜRÜN KODU	010 083 020432
	ÜRÜN ADI	MUT-430 CEE NORM 4/32 A MAKİNE PRİZİ (YENİ ÜRÜN)
	ADET/KOLİ	14/112
	FİYAT (₺)	277,85



CE	ÜRÜN KODU	010 083 030432
	ÜRÜN ADI	MUT-440 CEE NORM 4/32 A DUVAR PRİZİ (YENİ ÜRÜN)
	ADET/KOLİ	8/64
	FİYAT (₺)	354,65



CE	ÜRÜN KODU	010 083 000532
	ÜRÜN ADI	MUT-201 CEE NÖRM 5x32 A DÜZ FİŞ
	ADET/KOLİ	14/112
	FİYAT (₺)	298,18



CE	ÜRÜN KODU	010 083 020532
	ÜRÜN ADI	MUT-203 CEE NÖRM 5x32 A MAKİNE PRİZİ
	ADET/KOLİ	14/112
	FİYAT (₺)	305,41



CE	ÜRÜN KODU	010 083 010532
	ÜRÜN ADI	MUT-202 CEE NÖRM 5x32 A UZATMA PRİZİ
	ADET/KOLİ	12/96
	FİYAT (₺)	357,81



CE	ÜRÜN KODU	010 083 030532
	ÜRÜN ADI	MUT-204 CEE NÖRM 5x32 A DUVAR PRİZİ
	ADET/KOLİ	8/64
	FİYAT (₺)	390,12

## MUTLUSAN SANAYİ TİPİ FİŞ - PRİZ GRUBU (MONOFAZE 1x16A)



CE

ÜRÜN KODU	010 083 500298
ÜRÜN ADI	MUT-29/8 MONOFAZE TOP. PANO PRİZİ
ADET/KOLİ	40/320
FİYAT (₺)	55,46



CE

ÜRÜN KODU	010 083 500297
ÜRÜN ADI	MUT-29/7 MONOFAZE DUVAR PRİZİ (PLS.)
ADET/KOLİ	30/240
FİYAT (₺)	89,45



CE

ÜRÜN KODU	010 083 500299
ÜRÜN ADI	MUT-29/9 MONOFAZE MAKİNE PRİZİ
ADET/KOLİ	20/160
FİYAT (₺)	112,71



CE

ÜRÜN KODU	010 083 502910
ÜRÜN ADI	MUT-29/10 MONOFAZE DUVAR PRİZİ
ADET/KOLİ	15/120
FİYAT (₺)	149,69

## MUTLUSAN SANAYİ TİPİ FİŞ - PRİZ GRUBU (TRİFAZE 3x16A)



CE

ÜRÜN KODU	010 083 400064
ÜRÜN ADI	MUT-64 3x16 TRİFAZE MAKİNE PRİZİ (PLS.)
ADET/KOLİ	20/160
FİYAT (₺)	179,50



CE

ÜRÜN KODU	010 083 400063
ÜRÜN ADI	MUT-63 3x16 TRİFAZE DUVAR PRİZİ (PLS.)
ADET/KOLİ	12/96
FİYAT (₺)	200,97

## MUTLUSAN SANAYİ TİPİ FİŞ - PRİZ GRUBU (TRİFAZE 3x25A)



CE

ÜRÜN KODU	010 083 400318
ÜRÜN ADI	MUT-31/8 3x25 TRİFAZE MAKİNE PRİZİ (PLS.)
ADET/KOLİ	20/160
FİYAT (₺)	149,69



CE

ÜRÜN KODU	010 083 400319
ÜRÜN ADI	MUT-31/9 3x25 TRİFAZE DUVAR PRİZİ (PLS.)
ADET/KOLİ	15/120
FİYAT (₺)	190,83

## MUTLUSAN SANAYİ TİPİ FİŞ - PRİZ GRUBU (TRİFAZE 3x32A)



CE

ÜRÜN KODU	010 083 400074
ÜRÜN ADI	MUT-74 3x32 TRİFAZE MAKİNE PRİZİ (PLS.)
ADET/KOLİ	20/160
FİYAT (₺)	218,86



CE

ÜRÜN KODU	010 083 400073
ÜRÜN ADI	MUT-73 3x32 TRİFAZE DUVAR PRİZİ (PLS.)
ADET/KOLİ	12/96
FİYAT (₺)	256,43

## SİNTAŞ SANAYİ TİPİ FİŞ - PRİZLER

Ürün Kodu	Ürün Adı	Kutu Adet	Koli Adet	Fiyat (₺)
019 107 016250	16X25 A.4 KUTUPLU FİŞ-PRİZ	1	30	687,62
019 107 016252	16X25 A.4 KUTUPLU PRİZ	1	45	363,24
019 107 016251	16X25 A.4 KUTUPLU FİŞ	1	60	324,38
019 107 025400	25x40 A.4 KUTUPLU FİŞ-PRİZ	1	15	929,78
019 107 025402	25x40 A.4 KUTUPLU PRİZ	1	25	485,22
019 107 025401	25x40 A.4 KUTUPLU FİŞ	1	35	444,56
019 107 040630	40X63 A.4 KUTUPLU FİŞ-PRİZ	1	10	1.260,03
019 107 040632	40X63 A.4 KUTUPLU PRİZ	1	15	659,61
019 107 040631	40X63 A.4 KUTUPLU FİŞ	1	25	600,42
019 107 063100	63X100 A.4 KUTUPLU FİŞ-PRİZ	1	5	2.042,07
019 107 063102	63X100 A.4 KUTUPLU PRİZ	1	10	1.077,06
019 107 063101	63X100 A.4 KUTUPLU FİŞ	1	15	965,01



## SİNTAŞ SANAYİ TİPİ SEYYAR PRİZLER

Ürün Kodu	Ürün Adı	Kutu Adet	Koli Adet	Fiyat (₺)
019 107 016253	16X25 A.4 KUTUPLU SEYYAR PRİZ	1	45	363,24
019 107 025403	25x40 A.4 KUTUPLU SEYYAR PRİZ	1	25	485,22
019 107 040633	40X63 A.4 KUTUPLU SEYYAR PRİZ	1	15	659,61
019 107 063103	63X100 A.4 KUTUPLU SEYYAR PRİZ	1	10	1.077,06

## KABLO MAKARASI

Ürün Kodu	Ürün Adı	Kutu Adet	Koli Adet	Fiyat
005 083 700045	MONOFAZE PLS. BOŞ MAKARA 50 mt. KAPASİTELİ (4 MONOFAZE PRİZLİ)	1	1	23,72 \$



## TERMOPLASTİK BUATLAR VE KOMBİNASYON KUTULARI (GRİ-BEYAZ)

IP65

ÜRÜN KODU	001 046 000101 00 00
ÜRÜN ADI	85x85 KARE ANTİGRON BUAT
ADET/KOLİ	10/300
FİYAT (₺)	30,38

IP65

ÜRÜN KODU	001 046 071827 00 17/Gri 001 046 071827 00 00/Beyaz
ÜRÜN ADI	180x270x100 (14 ÇIKIŞ) TERMOPLASTİK BUAT
ADET/KOLİ	2/8
FİYAT (₺)	291,60 Gri / 329,17 Beyaz

IP65

ÜRÜN KODU	001 046 076131 00 17
ÜRÜN ADI	138x226x131 TERMOPLASTİK BUAT
ADET/KOLİ	1/8
FİYAT (₺)	274,80

IP40

ÜRÜN KODU	001 046 078080 00 17/Gri 001 046 078080 00 00/Beyaz
ÜRÜN ADI	80x80x48 (7 ÇIKIŞLI) TERMOPLASTİK BUAT
ADET/KOLİ	18/108
FİYAT (₺)	34,89 Gri / 36,4 Beyaz

IP65

ÜRÜN KODU	001 046 078226 00 17
ÜRÜN ADI	138x226x127 KOMBİNASYON KUTUSU
ADET/KOLİ	1/8
FİYAT (₺)	297,80

IP65

ÜRÜN KODU	001 046 072698 00 44
ÜRÜN ADI	138x226x98 (ŞEFFAF) TERMOPLASTİK BUAT
ADET/KOLİ	1/8
FİYAT (₺)	284,55

IP40

ÜRÜN KODU	001 046 078585 00 17/Gri 001 046 078585 00 00/Beyaz
ÜRÜN ADI	85x85x48 TERMOPLASTİK BUAT
ADET/KOLİ	18/108
FİYAT (₺)	32,92 Gri / 36,14 Beyaz

IP65

ÜRÜN KODU	001 046 075311 00 17
ÜRÜN ADI	225x311x132 KOMBİNASYON KUTUSU
ADET/KOLİ	1/4
FİYAT (₺)	492,12

IP65

ÜRÜN KODU	001 046 076131 00 44
ÜRÜN ADI	138x226x131 (ŞEFFAF) TERMOPLASTİK BUAT
ADET/KOLİ	1/8
FİYAT (₺)	293,99

IP40

ÜRÜN KODU	001 046 070090 00 17/Gri 001 046 070090 00 00/Beyaz
ÜRÜN ADI	Ø90 TERMOPLASTİK BUAT
ADET/KOLİ	18/108
FİYAT (₺)	58,6 Gri / 62,7 Beyaz

IP65

ÜRÜN KODU	001 046 071199 00 17
ÜRÜN ADI	225x311x99 TERMOPLASTİK BUAT
ADET/KOLİ	1/4
FİYAT (₺)	358,84

IP65

ÜRÜN KODU	001 046 071199 00 44
ÜRÜN ADI	225x311x99 (ŞEFFAF) TERMOPLASTİK BUAT
ADET/KOLİ	1/4
FİYAT (₺)	448,09

IP65

ÜRÜN KODU	001 046 071010 00 17/Gri 001 046 071010 00 00/Beyaz
ÜRÜN ADI	110x110x74 (8 ÇIKIŞ) TERMOPLASTİK BUAT
ADET/KOLİ	10/40
FİYAT (₺)	83,5 Gri / 90,14 Beyaz

IP65

ÜRÜN KODU	001 046 071130 00 17
ÜRÜN ADI	225x311x130 TERMOPLASTİK BUAT
ADET/KOLİ	1/4
FİYAT (₺)	396,96

IP65

ÜRÜN KODU	001 046 071130 00 44
ÜRÜN ADI	225x311x130 (ŞEFFAF) TERMOPLASTİK BUAT
ADET/KOLİ	1/4
FİYAT (₺)	473,07

IP65

ÜRÜN KODU	001 046 071118 00 17/Gri 001 046 071118 00 00/Beyaz
ÜRÜN ADI	110x180x77 (10 ÇIKIŞ) TERMOPL. BUAT
ADET/KOLİ	5/30
FİYAT (₺)	122,59 Gri / 133,57 Beyaz

IP65

ÜRÜN KODU	001 046 072698 00 17
ÜRÜN ADI	138x226x98 TERMOPLASTİK BUAT
ADET/KOLİ	1/8
FİYAT (₺)	237,83

## ALEV YAYMAYAN TERMOPLASTİK BUATLAR VE KOMBİNASYON KUTULARI (GRİ-BEYAZ)



IP40



ÜRÜN KODU	001 046 098080 00 17
ÜRÜN ADI	80x80x48 (7 ÇIKIŞLI) TERMOPLASTİK BUAT - A.YAYMAYAN
ADET/KOLİ	18/108
FİYAT (₺)	59,82

IP65



ÜRÜN KODU	001 046 098226 00 17
ÜRÜN ADI	138x226x127 KOMBİNASYON KUTUSU - A.YAYMAYAN
ADET/KOLİ	1/8
FİYAT (₺)	435,21

IP65



ÜRÜN KODU	001 046 092698 00 44
ÜRÜN ADI	138x226x98 (ŞEFFAF) TERMOPLASTİK BUAT - A.YAYMAYAN
ADET/KOLİ	1/8
FİYAT (₺)	327,64

IP40



ÜRÜN KODU	001 046 098585 00 17/Gri 001 046 098585 00 00/Beyaz
ÜRÜN ADI	85x85x48 TERMOPLASTİK BUAT - A.YAYMAYAN
ADET/KOLİ	18/108
FİYAT (₺)	71,15 Gri / 77,71 Beyaz

IP65



ÜRÜN KODU	001 046 095311 00 17
ÜRÜN ADI	225x311x132 KOMBİNASYON KUTUSU - A.YAYMAYAN
ADET/KOLİ	1/4
FİYAT (₺)	710,35

IP65



ÜRÜN KODU	001 046 096131 00 44
ÜRÜN ADI	138x226x131 (ŞEFFAF) TERMOPLASTİK BUAT - A.YAYMAYAN
ADET/KOLİ	1/8
FİYAT (₺)	356,49

IP40



ÜRÜN KODU	001 046 090090 00 17/Gri 001 046 090090 00 00/Beyaz
ÜRÜN ADI	Ø90 TERMOPLASTİK BUAT - A.YAYMAYAN
ADET/KOLİ	18/108
FİYAT (₺)	61,79 Gri / 66,12 Beyaz

IP65



ÜRÜN KODU	001 046 091199 00 17
ÜRÜN ADI	225x311x99 TERMOPLASTİK BUAT - A.YAYMAYAN
ADET/KOLİ	1/4
FİYAT (₺)	575,35

IP65



ÜRÜN KODU	001 046 091199 00 44
ÜRÜN ADI	225x311x99 (ŞEFFAF) TERMOPLASTİK BUAT - A.YAYMAYAN
ADET/KOLİ	1/4
FİYAT (₺)	559,31

IP65



ÜRÜN KODU	001 046 091010 00 17/Gri 001 046 091010 00 00/Beyaz
ÜRÜN ADI	110x110x74 (8 ÇIKIŞ) TERMOPLASTİK BUAT - A.YAYMAYAN
ADET/KOLİ	10/40
FİYAT (₺)	162,72 Gri / 174,11 Beyaz

IP65



ÜRÜN KODU	001 046 091130 00 17
ÜRÜN ADI	225x311x130 TERMOPLASTİK BUAT - A.YAYMAYAN
ADET/KOLİ	1/4
FİYAT (₺)	640,81

IP65



ÜRÜN KODU	001 046 091130 00 44
ÜRÜN ADI	225x311x130 (ŞEFFAF) TERMOPLASTİK BUAT - A.YAYMAYAN
ADET/KOLİ	1/4
FİYAT (₺)	586,28

IP65



ÜRÜN KODU	001 046 091118 00 17/Gri 001 046 091118 00 00/Beyaz
ÜRÜN ADI	110x180x77 (10 ÇIKIŞ) TERMOPLS. BUAT - A.YAYMAYAN
ADET/KOLİ	5/30
FİYAT (₺)	277,69 Gri / 297,13 Beyaz

IP65



ÜRÜN KODU	001 046 092698 00 17
ÜRÜN ADI	138x226x98 TERMOPLASTİK BUAT - A.YAYMAYAN
ADET/KOLİ	1/8
FİYAT (₺)	343,11

IP65



ÜRÜN KODU	001 046 091827 00 17/Gri 001 046 091827 00 00/Beyaz
ÜRÜN ADI	180x270x100 (14 ÇIKIŞ) TERMOPLS. BUAT A.YAYMAYAN
ADET/KOLİ	2/8
FİYAT (₺)	613,29 Gri / 650,09 Beyaz

IP65



ÜRÜN KODU	001 046 096131 00 17
ÜRÜN ADI	138x226x131 TERMOPLASTİK BUAT - A.YAYMAYAN
ADET/KOLİ	1/8
FİYAT	393,51



## KOMBİNASYON PANOLARI



ÜRÜN KODU	010 104 000180
ÜRÜN ADI	MK-325-2 3x25 A 1 ADET ÖN+ 1x16 A 2 ADET YAN
ADET/KOLİ	4
FİYAT (₺)	715,63



ÜRÜN KODU	010 104 000181
ÜRÜN ADI	MK-516-1 5x16 A 1 ADET ÖN+ 1x16 A 1 ADET YAN
ADET/KOLİ	6
FİYAT (₺)	506,90



ÜRÜN KODU	010 104 000182
ÜRÜN ADI	MK-516-2 5x16 A 1 ADET ÖN+ 1x16 A 2 ADET YAN
ADET/KOLİ	4
FİYAT (₺)	825,95



ÜRÜN KODU	010 104 000183
ÜRÜN ADI	MK-532-1 5x32 A 1 ADET ÖN+ 1x16 A 1 ADET YAN
ADET/KOLİ	6
FİYAT (₺)	551,63



ÜRÜN KODU	010 104 000184
ÜRÜN ADI	MK-532-2 5x32 A 1 ADET ÖN+ 1x16 A 2 ADET YAN
ADET/KOLİ	4
FİYAT (₺)	903,48



ÜRÜN KODU	010 104 000185
ÜRÜN ADI	MK-2325-2 3x25 A 2 ADET ÖN+ 1x16 A 2 ADET YAN
ADET/KOLİ	4
FİYAT (₺)	978,03



ÜRÜN KODU	010 104 000186
ÜRÜN ADI	MK-2516-2 5x16A 2 ADET ÖN+ 1x16 A 2 ADET YAN
ADET/KOLİ	4
FİYAT (₺)	1.225,51



ÜRÜN KODU	010 104 000187
ÜRÜN ADI	MK-2516-4 5x16 A 2 ADET ÖN+ 1x16 A 4 ADET YAN
ADET/KOLİ	4
FİYAT (₺)	1.341,80



ÜRÜN KODU	010 104 000188
ÜRÜN ADI	MK-2532-2 5x32 A 2 ADET ÖN+ 1x16 A 2 ADET YAN
ADET/KOLİ	4
FİYAT (₺)	1.431,26



ÜRÜN KODU	010 104 000189
ÜRÜN ADI	MK-2532-4 5x32 A 2 ADET ÖN+ 1x16 A 4 ADET YAN
ADET/KOLİ	4
FİYAT (₺)	1.541,58



ÜRÜN KODU	010 104 000190
ÜRÜN ADI	MK-5164-4 5x16A 4 ADET ÖN+ 1x16 A 4 ADET YAN
ADET/KOLİ	3
FİYAT (₺)	1.997,80



ÜRÜN KODU	010 104 000191
ÜRÜN ADI	MK-5324-4 5x32 A 4 ADET ÖN+ 1x16 A 4 ADET YAN
ADET/KOLİ	3
FİYAT (₺)	2.272,12

## KOMBİNASYON KUTULARI



ÜRÜN KODU	010 104 000192
ÜRÜN ADI	MK-51632-4 5x16A 2 ADET ÖN+5x32 A 2 AD. ÖN+ 1x16 A 4 ADET YAN
ADET/KOLİ	3
FİYAT (₺)	2.206,52



ÜRÜN KODU	001 046 075130 00 17
ÜRÜN ADI	1'Lİ KOMBİNASYON KUTUSU BOŞ 215x130 GRİ
ADET/KOLİ	1/10
FİYAT (₺)	297,67



ÜRÜN KODU	001 046 070220 00 17
ÜRÜN ADI	2'Lİ KOMBİNASYON KUTUSU BOŞ 290x220 GRİ
ADET/KOLİ	1/4
FİYAT (₺)	563,74

## KORUMA PANOLARI (YENİ ÜRÜN)



ÜRÜN KODU	010 104 000207
ÜRÜN ADI	GND MOB 16A MONOAZE MOBİL NÖTR TOPRAK REGÜLATÖRÜ
ADET/KOLİ	1
FİYAT (₺)	6.325,00



ÜRÜN KODU	010 104 000208
ÜRÜN ADI	GND MOB 32A MONOAZE MOBİL NÖTR TOPRAK REGÜLATÖRÜ
ADET/KOLİ	1
FİYAT (₺)	6.776,79



ÜRÜN KODU	010 104 000209
ÜRÜN ADI	GND MOB 32A TRİFAZE MOBİL NÖTR TOPRAK REGÜLATÖRÜ
ADET/KOLİ	1
FİYAT (₺)	11.204,29



ÜRÜN KODU	010 104 000210
ÜRÜN ADI	GND KOM KOMBİ NÖTR TOPRAK REGÜLATÖRÜ
ADET/KOLİ	1
FİYAT (₺)	4.517,86



ÜRÜN KODU	010 104 000211
ÜRÜN ADI	YMMUT3 MAKİNE KORUMA PANOSU
ADET/KOLİ	1
FİYAT (₺)	9.035,71

## KUTU MONTAJLI ÜRÜNLER



ÜRÜN KODU	010 104 000120
ÜRÜN ADI	MS-KK31 1'Lİ KUTULU START BUTONU (1NO)
ADET/KOLİ	18
FİYAT (₺)	149,09



ÜRÜN KODU	010 104 000121
ÜRÜN ADI	MS-KK42 1'Lİ KUTULU STOP BUTONU (1NC)
ADET/KOLİ	18
FİYAT (₺)	149,09



ÜRÜN KODU	010 104 000122
ÜRÜN ADI	MS-KK51 1'Lİ KUTULU START BUTONU (1NO)
ADET/KOLİ	18
FİYAT (₺)	149,09



ÜRÜN KODU	010 104 000123
ÜRÜN ADI	MS-BX71 1'Lİ KUTULU ALARM BUTONU (1NO)
ADET/KOLİ	18
FİYAT (₺)	155,65



ÜRÜN KODU	010 104 000124
ÜRÜN ADI	MS-BX81 1'Lİ KUTULU AYDINLATMA BUTONU (1NO)
ADET/KOLİ	18
FİYAT (₺)	155,65



ÜRÜN KODU	010 104 000125
ÜRÜN ADI	MS-KK7325 1'Lİ KUTULU İKİZ STOP BUTONU (1NO+1NC)
ADET/KOLİ	18
FİYAT (₺)	211,71



ÜRÜN KODU	010 104 000126
ÜRÜN ADI	MS-KK4151 1'Lİ KUTULU İŞARETLİ İKİZ BUTONU (1NO+1NO)
ADET/KOLİ	18
FİYAT (₺)	217,67



ÜRÜN KODU	010 104 000127
ÜRÜN ADI	MS-KBZ 1'Lİ KUTULU KABİN ALTI İKAZ LAMBASI BUZZERLİ
ADET/KOLİ	18
FİYAT (₺)	279,67

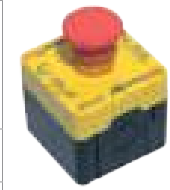

ÜRÜN KODU	010 090 050009
ÜRÜN ADI	MS-BX542 1'Lİ KUTULU ACİL STOP BUTONU (1NC)
ADET/KOLİ	18
FİYAT (₺)	178,91



ÜRÜN KODU	010 104 000129
ÜRÜN ADI	MS-BX542E 1'Lİ KUTULU EMERGENCY STOP BUTONU (1NC)
ADET/KOLİ	18
FİYAT (₺)	184,87



ÜRÜN KODU	010 104 000130
ÜRÜN ADI	MS-BX542ASP 1'Lİ KUT. MÜHÜRLÜ TİP KOR. ACİL STOP BUTONU (1NC)
ADET/KOLİ	12
FİYAT (₺)	328,73



ÜRÜN KODU	010 104 000131
ÜRÜN ADI	MS-BYP3K 1'Lİ KUTULU 3 KADEME BY-PASS ANAHTARI
ADET/KOLİ	12
FİYAT (₺)	584,43



ÜRÜN KODU	010 104 000132
ÜRÜN ADI	MS-BYK4K 1'Lİ KUTULU 4 KADEME BY-PASS ANAHTARLI
ADET/KOLİ	12
FİYAT (₺)	651,22



ÜRÜN KODU	010 104 000133
ÜRÜN ADI	MS-KANT 1'Lİ KUTULU KAYICI RESET ANAHTARI
ADET/KOLİ	12
FİYAT (₺)	256,42

## EKO SERİSİ KUMANDA KUTULARI

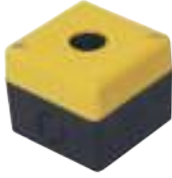

ÜRÜN KODU	010 104 000105
ÜRÜN ADI	EKO101S EKO 1'Lİ BOŞ KUMANDA KUTUSU
ADET/KOLİ	90
FİYAT (₺)	45,89



ÜRÜN KODU	010 104 000106
ÜRÜN ADI	EKO201S EKO 1'Lİ KORUMALI BOŞ KUMANDA KUTUSU
ADET/KOLİ	50
FİYAT (₺)	49,64



ÜRÜN KODU	010 104 000107
ÜRÜN ADI	EKO301S EKO 1'Lİ ACİL STOP ETİ. KOR.YAZILI KUMANDA KUTUSU
ADET/KOLİ	50
FİYAT (₺)	149,09



ÜRÜN KODU	010 104 000156
ÜRÜN ADI	EKO401S EKO 1'Lİ ACİL STOPLU KUMANDA KUTUSU
ADET/KOLİ	50
FİYAT (₺)	144,57

## BOŞ KUMANDA KUTULARI



ÜRÜN KODU	010 091 010001
ÜRÜN ADI	1'Lİ ETANJ BUTON KUTUSU EUROBOX
ADET/KOLİ	24
FİYAT (₺)	81,92



ÜRÜN KODU	010 091 010002
ÜRÜN ADI	2'Lİ ETANJ BUTON KUTUSU EUROBOX
ADET/KOLİ	18
FİYAT (₺)	101,20



ÜRÜN KODU	010 091 010003
ÜRÜN ADI	3'LÜ ETANJ BUTON KUTUSU EUROBOX
ADET/KOLİ	12
FİYAT (₺)	135,54



ÜRÜN KODU	010 091 010004
ÜRÜN ADI	4'LÜ ETANJ BUTON KUTUSU EUROBOX
ADET/KOLİ	10
FİYAT (₺)	158,32

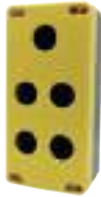

ÜRÜN KODU	010 104 000114
ÜRÜN ADI	SW-BX05SB 5'Lİ ETANJ BUTON KUTUSU EUROBOX
ADET/KOLİ	8
FİYAT (₺)	320,68



ÜRÜN KODU	010 104 000115
ÜRÜN ADI	SW-BX06SB 6'Lİ ETANJ BUTON KUTUSU EUROBOX
ADET/KOLİ	8
FİYAT (₺)	320,68



ÜRÜN KODU	010 104 000116
ÜRÜN ADI	SW-BX07SB 7'Lİ ETANJ BUTON KUTUSU EUROBOX
ADET/KOLİ	6
FİYAT (₺)	320,68

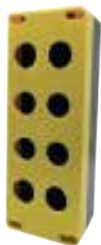

ÜRÜN KODU	010 104 000117
ÜRÜN ADI	SW-BX08SB 8'Lİ ETANJ BUTON KUTUSU EUROBOX
ADET/KOLİ	6
FİYAT (₺)	320,68



ÜRÜN KODU	010 104 000118
ÜRÜN ADI	SW-BX09SB 9'LÜ ETANJ BUTON KUTUSU EUROBOX
ADET/KOLİ	1
FİYAT (₺)	510,52



ÜRÜN KODU	010 104 000119
ÜRÜN ADI	SW-BX10SB 10'LU ETANJ BUTON KUTUSU EUROBOX
ADET/KOLİ	1
FİYAT (₺)	510,52

## ASANSÖR KUYU DİBİ SETLERİ VE KUMANDALARI



ÜRÜN KODU	010 104 000134
ÜRÜN ADI	MS-KYD02 2'Lİ ASANSÖR KUYU DİBİ BUTON 220V 16A TOP. PRİZ+ACİL STOP BUTON
ADET/KOLİ	9
FİYAT (₺)	304,51



ÜRÜN KODU	010 104 000135
ÜRÜN ADI	MS-KYD03 ACİL STOP BUTON + SEÇİCİ BUTON (2NO) 220V 16A TOP. PANO PRİZİ
ADET/KOLİ	6
FİYAT (₺)	462,18



ÜRÜN KODU	010 104 000136
ÜRÜN ADI	MS-KYD04 6'Lİ ACİL STOP BUT.+2 AD. OKLU BUT. (1NO) 1 İKİZ BUT. ( 2NO) 1 SEÇ.BUT. (2NO)
ADET/KOLİ	5
FİYAT (₺)	757,37



ÜRÜN KODU	010 104 000137
ÜRÜN ADI	MS-KYD05 ACİL STOP BUT.+ 2 OKLU BUT.ORTAK OKLU (1NO) SEÇ.BUT. (2NO-1NC)
ADET/KOLİ	4
FİYAT (₺)	699,42



ÜRÜN KODU	010 104 000138
ÜRÜN ADI	MS-KYD06 ACİL STOP BUT.+ 2 OKLU BUT.(2NO)1 ORTAK BUT.(1NO) ALARM BUT.+SEÇ.BUT. (2NO-1NC)
ADET/KOLİ	2
FİYAT (₺)	757,37



ÜRÜN KODU	010 104 000139
ÜRÜN ADI	KY2-ALR KORUMALI ACİL STOP BUT.(1NC) NO KONTAKLI ALARM BUTONU KOMBİNASYON
ADET/KOLİ	10
FİYAT (₺)	304,14



ÜRÜN KODU	010 104 000140
ÜRÜN ADI	MS-KY5-24 KOR.ACİL STOP BUT.(1NC) LAMB.VAVİEN (1NO)24V KATTA LED (1NO) ALARM BUT. 16A.KAP.PRİZ
ADET/KOLİ	4
FİYAT (₺)	793,71



ÜRÜN KODU	010 104 000141
ÜRÜN ADI	MS-KY3 KOR.ACİL STOP BUT.+ ALARM BUT.+16A KAPAKLI PRİZ KOMBİNASYON
ADET/KOLİ	5
FİYAT (₺)	441,30



ÜRÜN KODU	010 104 000142
ÜRÜN ADI	MS-KY3ES5012 KOR. ACİL STOP BUT. +ALARM+9V PİLLİ 130 dB KOMBİNASYON
ADET/KOLİ	5
FİYAT (₺)	715,63



ÜRÜN KODU	010 104 000143
ÜRÜN ADI	MS-KY4ES5012 KOR. ACİL STOP BUT. +9V PİLLİ 130 dB ALARM + 16A KAP. PRİZ KOMBİNASYON
ADET/KOLİ	4
FİYAT (₺)	793,71



ÜRÜN KODU	010 091 020001
ÜRÜN ADI	MS-LV4 YUKARI (1NO)AŞAĞI (1NO) 0-1 REVİZYON (1NO) ACİL STOP BUT. (1NC) EL TERMİNALİ (EL KUMANDA)
ADET/KOLİ	6
FİYAT (₺)	561,50



ÜRÜN KODU	010 104 000145
ÜRÜN ADI	MS-LV5 YUKARI (1NO) ORTAK (1NO) AŞAĞI (1NO) 0-1 REVİZYON (1NO) ACİL STOP BUT.(1NC) 16A KAP. PRİZ EL TERMİNALİ
ADET/KOLİ	4
FİYAT (₺)	793,71



ÜRÜN KODU	010 104 000146
ÜRÜN ADI	MS3BY-BG53P 3KD. BY-PASSLI LAMBA BUT.(1NO) 24V KATTA LEDLİ REG.AÇMA (1NO) 16A KAP.PRİZ KOMBİNASYON
ADET/KOLİ	4
FİYAT (₺)	1.085,37



ÜRÜN KODU	010 104 000147
ÜRÜN ADI	MS9-BX07 YUKARI (1NO)AŞAĞI (1NO) ORTAK(1NO) 24V KATTA LEDLİ KOR. ACİL STOP(1NC) ALR. (1NO)LAM.(1NO) KOR.0-1REV.(1NO)16A
ADET/KOLİ	1
FİYAT (₺)	1.168,86



ÜRÜN KODU	010 104 000148
ÜRÜN ADI	MS102-ED21 3BY 3KD.BYP REG.KİL. (1NO) REG.AÇ(1NO) 24V KATTA LED FREN AÇMA (1NO) KOR.0-1SET RESET (1NO)
ADET/KOLİ	4
FİYAT (₺)	1.204,64



ÜRÜN KODU	010 104 000149
ÜRÜN ADI	MS201-ED21 REG.AÇ KAPA (2NO)24V KATTA LED LAMBA BUT. (1NO) FREN AÇMA1 (1NO) FREN AÇMA2(1NO)KOR.SET RESET (2NO)
ADET/KOLİ	4
FİYAT (₺)	805,08



010 104 000150



010 104 000151



010 104 000152

## LİFT KUMANDA BUTONU - ÇİFT KONTAKLI

Ürün Kodu	Ürün Adı	Koli Adet	Fiyat (₺)
010 104 000150	MLK-2 TEK HIZLI 2'Lİ LİFT KUMANDA - ÇİFT KONTAKLI -10A	1	1.192,71
010 104 000151	MLK-3 TEK HIZLI 3'LÜ LİFT KUMANDA - ÇİFT KONTAKLI -10A	1	1.610,16
010 104 000152	MLK-4 TEK HIZLI 4'LÜ LİFT KUMANDA - ÇİFT KONTAKLI -10A	1	1.866,60



010 092 000001



010 092 000002



010 092 000003



010 092 000004



010 092 000005



010 092 000006

## VİNÇ KUTULARI

Ürün Kodu	Ürün Adı	Koli Adet	Fiyat (₺)
010 092 000001	İKİLİ VİNÇ KUTUSU - TEK HIZLI	1	819,99
010 092 000002	ÜÇLÜ VİNÇ KUTUSU - TEK HIZLI	1	935,20
010 092 000003	DÖRTLÜ VİNÇ KUTUSU - TEK HIZLI	1	1.057,18
010 092 000004	BEŞLİ VİNÇ KUTUSU - TEK HIZLI	1	1.174,64
010 092 000005	ALTI Lİ VİNÇ KUTUSU - TEK HIZLI	1	1.432,16
010 092 000006	YEDİLİ VİNÇ KUTUSU - TEK HIZLI	1	1.549,63



010 104 000003



010 104 000004



010 104 000005



010 104 000006



010 104 000007



010 104 000008

## SWISS SERİSİ PLASTİK YAYLI BUTONLAR

Ürün Kodu	Ürün Adı	Koli Adet	Fiyat (₺)
010 104 000003	SW-AA42 22 mm PLASTİK YAYLI BUTON - STOP	10	63,25
010 104 000004	SW-AA31 22 mm PLASTİK YAYLI BUTON - START	10	63,25
010 104 000005	SW-AA51 22 mm PLASTİK YAYLI BUTON - START	10	63,25
010 104 000006	SW-AA61 22 mm PLASTİK YAYLI BUTON - START	10	63,25
010 104 000007	SW-AA21 22 mm PLASTİK YAYLI BUTON - START	10	63,25
010 104 000008	SW-AA11 22 mm PLASTİK YAYLI BUTON - START	10	63,25

## SWISS SERİSİ PLASTİK KALICI BUTONLAR

Ürün Kodu	Ürün Adı	Koli Adet	Fiyat (₺)
010 104 000195	SW-K42 22MM PLASTİK KALICI BUTON STOP (YENİ ÜRÜN)	10	119,27
010 104 000196	SW-K31 22MM PLASTİK KALICI BUTON START (YENİ ÜRÜN)	10	119,27
010 104 000197	SW-K51 22MM PLASTİK KALICI BUTON START (YENİ ÜRÜN)	10	119,27
010 104 000198	SW-K61 22MM PLASTİK KALICI BUTON START (YENİ ÜRÜN)	10	119,27
010 104 000199	SW-KA21 22MM PLASTİK KALICI BUTON START (YENİ ÜRÜN)	10	119,27
010 104 000200	SW-KA11 22MM PLASTİK KALICI BUTON START (YENİ ÜRÜN)	10	119,27



010 104 000009



010 104 000010



010 104 000011



010 104 000012



010 104 000013



010 104 000014

## SWISS SERİSİ PLASTİK YAYLI BUTONLAR

Ürün Kodu	Ürün Adı	Koli Adet	Fiyat (₺)
010 104 000009	SW-AA4322 22 mm PLASTİK YAYLI BUTON - STOP	10	66,41
010 104 000010	SW-AA3361 22 mm PLASTİK YAYLI BUTON - START	10	66,41
010 104 000011	SW-AA3351 22 mm PLASTİK YAYLI BUTON - START	10	66,41
010 104 000012	SW-AA3341 22 mm PLASTİK YAYLI BUTON - START	10	66,41
010 104 000013	SW-AA3371 22 mm PLASTİK YAYLI BUTON - START	10	66,41
010 104 000014	SW-AA3381 22 mm PLASTİK YAYLI BUTON - START	10	66,41



010 104 000015



010 104 000016



010 104 000017



010 104 000018



010 104 000019



010 104 000020



010 104 000021



010 104 000022



010 104 000023



010 104 000024

## SWISS SERİSİ PLASTİK YAYLI İKİZ BUTONLAR

Ürün Kodu	Ürün Adı	Koli Adet	Fiyat (₺)
010 104 000015	SW-AL7325 22 mm PLASTİK İKİZ BUTON (1NO+1NC)	10	129,66
010 104 000016	SW-AL7181 22 mm PLASTİK ALARM - LAMBA İKİZ BUTON (1NO+1NO)	10	142,76
010 104 000017	SW-AL4252 22 mm PLASTİK YUKARI AŞAĞI OKLU TERS YÖNLÜ İKİZ BUTON (1NO+1NO)	10	142,76
010 104 000018	SW-AL6171 22 mm PLASTİK ALARM ORTAK OKLU İKİZ BUTON (1NO+1NO)	10	142,76
010 104 000019	SW-AL6181 22 mm PLASTİK LAMBA ORTAK OKLU İKİZ BUTON (1NO+1NO)	10	142,76
010 104 000020	SW-AL7425 22 mm PLASTİK İŞARETLİ İKİZ BUTON (1NO+1NC)	10	142,76
010 104 000021	SW-AL7525 22 mm PLASTİK YAZILI İKİZ BUTON (1NO+1NC)	10	142,76
010 104 000022	SW-AL4151 22 mm PLASTİK YUKARI AŞAĞI OKLU BUTON (1NO+1NO)	10	142,76
010 104 000023	SW-AL7465L 22 mm PLASTİK İKİZ BUTON (1NO+1NC) LEDLİ 220V AC/DC	10	240,12
010 104 000024	SW-AL7465-24L 22 mm PLASTİK İKİZ BUTON (1NO+1NC) LEDLİ 24V AC/DC	10	240,12



010 104 000025



010 104 000026



010 104 000027



010 104 000028

## SWISS SERİSİ PLASTİK KALICI VE KAYICI MANDAL BUTONLAR

Ürün Kodu	Ürün Adı	Koli Adet	Fiyat (₺)
010 104 000025	SW-AD21 PLASTİK KALICI 0 - 1 MANDAL BUTON (1NO)	10	74,54
010 104 000026	SW-AD41 PLASTİK KAYICI 0 - 1 MANDAL BUTON (1NO)	10	84,48
010 104 000027	SW-AD33 PLASTİK KALICI 2 - 0 - 1 MANDAL BUTON (1NO+1NO)	10	108,43
010 104 000028	SW-AD53 PLASTİK KAYICI 2 - 0 - 1 MANDAL BUTON (1NO+1NO)	10	117,46



010 104 000029



010 104 000030



010 104 000031



010 104 000032

## SWISS SERİSİ PLASTİK ANAHTARLI KALICI VE KAYICI MANDAL BUTONLAR

Ürün Kodu	Ürün Adı	Koli Adet	Fiyat (₺)
010 104 000029	SW-AG21 PLASTİK KALICI 0 - 1 ANAHTARLI MANDAL BUTON (1NO)	10	197,88
010 104 000030	SW-AG41 PLASTİK KAYICI 0 - 1 ANAHTARLI MANDAL BUTON (1NO)	10	197,88
010 104 000031	SW-AG33 PLASTİK KALICI 2 - 0 - 1 ANAHTARLI MANDAL BUTON (1NO+1NO)	10	232,67
010 104 000032	SW-AG53 PLASTİK KAYICI 2 - 0 - 1 ANAHTARLI MANDAL BUTON (1NO+1NO)	10	232,67



010 104 000037



010 104 000038



010 104 000039

## SWISS SERİSİ PLASTİK KAYICI MANTAR BUTONLAR

Ürün Kodu	Ürün Adı	Koli Adet	Fiyat (₺)
010 104 000037	SW-AC42 40MM KAFA PLASTİK KAYICI MANTAR BUTON (1NC)	10	101,20
010 104 000038	SW-AC31 40MM KAFA PLASTİK KAYICI MANTAR BUTON (1NO)	10	101,20
010 104 000039	SW-AC51 40MM KAFA PLASTİK KAYICI MANTAR BUTON (1NO)	10	101,20





010 104 000033



010 104 000034



010 104 000035



010 104 000036

## SWISS SERİSİ PLASTİK MANTAR ACİL STOP BUTONLAR

Ürün Kodu	Ürün Adı	Koli Adet	Fiyat (₺)
010 104 000033	SW-AS142 40 mm KAFA PLASTİK ANAHTARLI MANTAR BUTON (1NC) ACİL STOP	10	225,89
010 104 000034	SW-AS542E 40 mm KAFA PLASTİK MANTAR BUTON (1NC) ACİL STOP ETİKETLİ	10	112,95
010 104 000035	SW-AS542 40 mm KAFA PLASTİK MANTAR BUTON (1NC) ACİL STOP	10	94,88
010 104 000036	SW-AS442 30 mm KAFA PLASTİK MANTAR BUTON (1NC) ACİL STOP	10	118,07



010 104 000040



010 104 000041



010 104 000042



010 104 000043



010 104 000044



010 104 000045



010 104 000046



010 104 000047

## SWISS SERİSİ PLASTİK LEDLİ, IŞIKLI, YAYLI BUTONLAR

Ürün Kodu	Ürün Adı	Koli Adet	Fiyat (₺)
010 104 000040	SW-AW3475 22 mm LEDLİ IŞIKLI YAYLI BUTON STOP - 110-240V AC	10	185,23
010 104 000041	SW-AW3475 22 mm LEDLİ IŞIKLI YAYLI BUTON STOP - 10-30V DC	10	185,23
010 104 000042	SW-AW3375 22 mm LEDLİ IŞIKLI YAYLI BUTON START - 110-240V AC	10	185,23
010 104 000043	SW-AW3375-24 22 mm LEDLİ IŞIKLI YAYLI BUTON START - 10-30V DC	10	185,23
010 104 000044	SW-AW3575 22 mm LEDLİ IŞIKLI YAYLI BUTON START - 110-240V AC	10	185,23
010 104 000045	SW-AW3575-24 22 mm LEDLİ IŞIKLI YAYLI BUTON START - 10-30V DC	10	185,23
010 104 000046	SW-AW3675 22 mm LEDLİ IŞIKLI YAYLI BUTON START - 110-240V AC	10	185,23
010 104 000047	SW-AW3675-24 22 mm LEDLİ IŞIKLI YAYLI BUTON START - 10-30V DC	10	185,23



010 104 000001



010 104 000002

## POTANSİYOMETRE

Ürün Kodu	Ürün Adı	Koli Adet	Fiyat (₺)
010 104 000001	MS22-5K POTANS 5K	15	357,81
010 104 000002	MS22-10K POTANS 10K	15	357,81



010 104 000054



010 104 000055



010 104 000056



010 104 000057



010 104 000058



010 104 000059

## SWISS SERİSİ 1-0-2 PLASTİK LEDLİ, IŞIKLI KALICI MANDAL BUTONLAR

Ürün Kodu	Ürün Adı	Koli Adet	Fiyat (₺)
010 104 000054	SW-AK323L 1-0-2 PLASTİK LEDLİ KALICI MANDAL BUTON (2NO) 110-240V AC	10	231,98
010 104 000055	SW-AK324L 1-0-2 PLASTİK LEDLİ KALICI MANDAL BUTON (2NC) 110-240V AC	10	231,98
010 104 000056	SW-AK325L 1-0-2 PLASTİK LEDLİ KALICI MANDAL BUTON (2NO) 110-240V AC	10	231,98
010 104 000057	SW-AK323-24L 1-0-2 PLASTİK LEDLİ KALICI MANDAL BUTON (2NO) 10-24V AC/DC	10	231,98
010 104 000058	SW-AK324-24L 1-0-2 PLASTİK LEDLİ KALICI MANDAL BUTON (2NC) 10-24V AC/DC	10	231,98
010 104 000059	SW-AK325-24L 1-0-2 PLASTİK LEDLİ KALICI MANDAL BUTON (2NO) 10-24V AC/DC	10	231,98



010 104 000048



010 104 000049



010 104 000050



010 104 000051



010 104 000052



010 104 000053

## SWISS SERİSİ 0-1 PLASTİK LEDLİ, IŞIKLI KALICI MANDAL BUTONLAR

Ürün Kodu	Ürün Adı	Koli Adet	Fiyat (₺)
010 104 000048	SW-AK123L 0-1 PLASTİK LEDLİ KALICI MANDAL BUTON (1NO) 110-240V AC	10	196,53
010 104 000049	SW-AK124L 0-1 PLASTİK LEDLİ KALICI MANDAL BUTON (1NC) 110-240V AC	10	196,53
010 104 000050	SW-AK125L 0-1 PLASTİK LEDLİ KALICI MANDAL BUTON (1NO) 110-240V AC	10	196,53
010 104 000051	SW-AK123-24L 0-1 PLASTİK LEDLİ KALICI MANDAL BUTON (1NO) 10-24V AC/DC	10	196,53
010 104 000052	SW-AK124-24L 0-1 PLASTİK LEDLİ KALICI MANDAL BUTON (1NC) 10-24V AC/DC	10	196,53
010 104 000053	SW-AK125-24L 0-1 PLASTİK LEDLİ KALICI MANDAL BUTON (1NO) 10-24V AC/DC	10	196,53



010 104 000064

010 104 000065

010 104 000066

010 104 000067

010 104 000068

010 104 000069

## SWISS SERİSİ METAL KAPLAMALI YAYLI BUTONLAR

Ürün Kodu	Ürün Adı	Koli Adet	Fiyat (₺)
010 104 000064	SW-BA42 22 mm YAYLI BUTON STOP (1NC)	10	70,03
010 104 000065	SW-BA31 22 mm YAYLI BUTON START (1NO)	10	70,03
010 104 000066	SW-BA51 22 mm YAYLI BUTON START (1NO)	10	70,03
010 104 000067	SW-BA11 22 mm YAYLI BUTON START (1NO)	10	70,03
010 104 000068	SW-BA61 22 mm YAYLI BUTON START (1NO)	10	70,03
010 104 000069	SW-BA21 22 mm YAYLI BUTON START (1NO)	10	70,03

## SWISS SERİSİ METAL KAPLAMALI KALICI BUTONLAR

Ürün Kodu	Ürün Adı	Koli Adet	Fiyat (₺)
010 104 000201	SW-BK42 22 MM YAYLI KALICI BUTON STOP (1NC) (YENİ ÜRÜN )	10	128,31
010 104 000202	SW-BK31 22 MM YAYLI KALICI BUTON START (1NC) (YENİ ÜRÜN )	10	128,31
010 104 000203	SW-BK51 22 MM YAYLI KALICI BUTON START (1NC) (YENİ ÜRÜN )	10	128,31
010 104 000204	SW-BK11 22 MM YAYLI KALICI BUTON START (1NC) (YENİ ÜRÜN )	10	128,31
010 104 000205	SW-BK61 22 MM YAYLI KALICI BUTON START (1NC) (YENİ ÜRÜN )	10	128,31
010 104 000206	SW-BK21 22 MM YAYLI KALICI BUTON START (1NC) (YENİ ÜRÜN )	10	128,31



010 104 000071

010 104 000072

010 104 000073

010 104 000074

010 104 000075

010 104 000076

## SWISS SERİSİ METAL KAPLAMALI İŞARETLİ YAYLI BUTONLAR

Ürün Kodu	Ürün Adı	Koli Adet	Fiyat (₺)
010 104 000071	SW-BA4322 22 mm İŞARETLİ YAYLI BUTON STOP (1NC)	10	76,33
010 104 000072	SW-BA3351 22 mm İŞARETLİ YAYLI BUTON START (1NO)	10	76,33
010 104 000073	SW-BA3341 22 mm İŞARETLİ YAYLI BUTON START (1NO)	10	76,33
010 104 000074	SW-BA3361 22 mm İŞARETLİ YAYLI BUTON START (1NO)	10	76,33
010 104 000075	SW-BA3371 22 mm İŞARETLİ YAYLI BUTON START (1NO)	10	76,33
010 104 000076	SW-BA3381 22 mm İŞARETLİ YAYLI BUTON START (1NO)	10	76,33



010 104 000077

010 104 000078

010 104 000079

## SWISS SERİSİ METAL KAPLAMALI İKİZ BUTONLAR

Ürün Kodu	Ürün Adı	Koli Adet	Fiyat (₺)
010 104 000077	SW-BL7325 22 mm PLASTİK İKİZ BUTON (1NO+1NC)	10	142,31
010 104 000078	SW-BL7425 22 mm PLASTİK İKİZ BUTON (1NO+1NC)	10	157,44
010 104 000079	SW-BL7525 22 mm PLASTİK YAZILI İKİZ BUTON (1NO+1NC)	10	157,44



010 104 000080

010 104 000081

010 104 000082

010 104 000083

010 104 000084

010 104 000085

010 104 000086

## SWISS SERİSİ METAL KAPLAMALI İKİZ BUTONLAR

Ürün Kodu	Ürün Adı	Koli Adet	Fiyat (₺)
010 104 000080	SW-BL4151 22 mm PLASTİK YUKARI AŞAĞI OKLU İKİZ BUTON (1NO+1NO)	10	157,44
010 104 000081	SW-BL4252 22 mm PLASTİK YUKARI AŞAĞI TERS YÖN OKLU İKİZ BUTON (1NO+1NO)	10	157,44
010 104 000082	SW-BL6171 22 mm PLASTİK ALARM ORTAK OKLU İKİZ BUTON (1NO+1NO)	10	157,44
010 104 000083	SW-BL7181 22 mm PLASTİK ALARM - LAMBA İKİZ BUTON (1NO+1NO)	10	157,44
010 104 000084	SW-BL6181 22 mm PLASTİK LAMBA ORTAK OKLU İKİZ BUTON (1NO+1NO)	10	157,44
010 104 000085	SW-BL7465L 22 mm PLASTİK İKİZ BUTON LEDLİ (220V AC)	10	264,29
010 104 000086	SW-BL7465L-24L 22 mm PLASTİK İKİZ BUTON LEDLİ (24V AC/DC)	10	264,29



010 104 000087



010 104 000088



010 104 000089



010 104 000090

## SWISS SERİSİ METAL KAPLAMALI KALICI VE KAYICI MANDAL BUTONLAR

Ürün Kodu	Ürün Adı	Koli Adet	Fiyat (₺)
010 104 000087	SW-BD21 0-1 KALICI MANDAL BUTON (1NO)	10	82,00
010 104 000088	SW-BD41 0-1 KAYICI MANDAL BUTON (1NO)	10	92,62
010 104 000089	SW-BD33 1-0-2 KALICI MANDAL BUTON (1NO+1NO)	10	119,72
010 104 000090	SW-BD53 1-0-2 KAYICI MANDAL BUTON (1NO+1NO)	10	131,02



010 104 000168



010 104 000169



010 104 000170



010 104 000171



010 104 000172



010 104 000173

## SWISS SERİSİ METAL KAPLAMALI 0-1 LEDLİ KALICI BUTONLAR

Ürün Kodu	Ürün Adı	Koli Adet	Fiyat (₺)
010 104 000168	SW-BK123L 0-1 LEDLİ İŞIKLI KALICI MANDAL BUTON (1NO) 110-240V AC	10	206,73
010 104 000169	SW-BK124L 0-1 LEDLİ İŞIKLI KALICI MANDAL BUTON (1NC) 110-240V AC	10	206,73
010 104 000170	SW-BK125L 0-1 LEDLİ İŞIKLI KALICI MANDAL BUTON (1NO) 110-240V AC	10	206,73
010 104 000171	SW-BK123L-24L 0-1 LEDLİ İŞIKLI KALICI MANDAL BUTON (1NO) 10-30V AC/DC	10	206,73
010 104 000172	SW-BK124L-24L 0-1 LEDLİ İŞIKLI KALICI MANDAL BUTON (1NC) 10-30V AC/DC	10	206,73
010 104 000173	SW-BK125L-24L 0-1 LEDLİ İŞIKLI KALICI MANDAL BUTON (1NC) 10-30V AC/DC	10	206,73



010 104 000160



010 104 000162



010 104 000164



010 104 000166



010 104 000161



010 104 000163



010 104 000165



010 104 000167

## SWISS SERİSİ METAL KAPLAMALI LEDLİ İŞIKLI YAYLI BUTONLAR

Ürün Kodu	Ürün Adı	Koli Adet	Fiyat (₺)
010 104 000160	BW-3475 22 mm LEDLİ İŞIKLI YAYLI BUTON STOP 110-240V AC	10	189,75
010 104 000161	BW-3475-24L 22 mm LEDLİ İŞIKLI YAYLI BUTON STOP 10-30V AC/DC	10	189,75
010 104 000162	BW-3375 22 mm LEDLİ İŞIKLI YAYLI BUTON START 110-240V AC	10	189,75
010 104 000163	BW-3375-24L 22 mm LEDLİ İŞIKLI YAYLI BUTON START 10-30V AC/DC	10	189,75
010 104 000164	BW-3575 22 mm LEDLİ İŞIKLI YAYLI BUTON START 110-240V AC	10	189,75
010 104 000165	BW-3575-24L 22 mm LEDLİ İŞIKLI YAYLI BUTON START 10-30V AC/DC	10	189,75
010 104 000166	BW-3675 22 mm LEDLİ İŞIKLI YAYLI BUTON START 110-240V AC	10	189,75
010 104 000167	BW-3675-24L 22 mm LEDLİ İŞIKLI YAYLI BUTON START 10-30V AC/DC	10	189,75



010 104 000174



010 104 000175



010 104 000176



010 104 000177



010 104 000178



010 104 000179

## SWISS SERİSİ METAL KAPLAMALI 0-1-2 LEDLİ KALICI MANDAL BUTONLAR

Ürün Kodu	Ürün Adı	Koli Adet	Fiyat (₺)
010 104 000174	BK-323L 1-0-2 PLASTİK LEDLİ KALICI MANDAL BUTON (2NO) 110-240V AC	10	241,08
010 104 000175	BK-324L 1-0-2 PLASTİK LEDLİ KALICI MANDAL BUTON (2NC) 110-240V AC	10	241,08
010 104 000176	BK-325L 1-0-2 PLASTİK LEDLİ KALICI MANDAL BUTON (2NO) 110-240V AC	10	241,08
010 104 000177	BK-323-24L 1-0-2 PLASTİK LEDLİ KALICI MANDAL BUTON (2NO) 10-24V AC/DC	10	241,08
010 104 000178	BK-324-24L 1-0-2 PLASTİK LEDLİ KALICI MANDAL BUTON (2NC) 10-24V AC/DC	10	241,08
010 104 000179	BK-325-24L 1-0-2 PLASTİK LEDLİ KALICI MANDAL BUTON (2NO) 10-24V AC/DC	10	241,08



010 104 000060



010 104 000061



010 104 000062

## YAYLI BUTON YEDEK KONTAKLARI VE KILIFI

Ürün Kodu	Ürün Adı	Koli Adet	Fiyat (₺)
010 104 000060	SW-BE101 KONTAK BLOK (NO)	50	35,24
010 104 000061	SW-BE102 KONTAK BLOK (NC)	50	35,24
010 104 000062	SW-BE103 İŞIK SOKETİ 10/30 110-240V AC	50	121,98

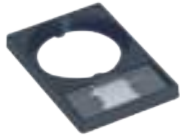

010 104 000091

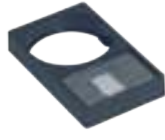

010 104 000092

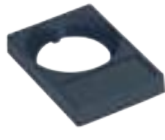

010 104 000093



010 093 000002



010 093 000001



010 093 000099

## BUTON AKSESUARLARI

Ürün Kodu	Ürün Adı	Koli Adet	Fiyat (₺)
010 104 000091	SW-BR1 PLASTİK BUTON ROZETİ 26x8 CAMLI	100	23,94
010 104 000092	SW-BR2 PLASTİK BUTON ROZETİ 26x18 CAMLI	100	27,11
010 104 000093	SW-SİE-R PLASTİK BUTON ROZETİ 27x12 CAMSIZ	100	21,74
010 093 000002	SW-BRY PLASTİK YAZILI BUTON ROZETİ	100	15,71
010 093 000001	SW-AP2 BUTON KORUMA KILIFI (YAYLI BUTONLAR İÇİN)	50	29,82
010 104 000099	SW-AP4 IP67 İKİZ BUTON KORUMA KILIFI (YAYLI BUTONLAR İÇİN)	50	29,82



010 104 000095



010 104 000096



010 093 000003



010 090 050008

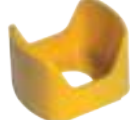

010 104 000101



010 104 000102



010 104 000104

## ACİL STOP ETİKETLERİ

Ürün Kodu	Ürün Adı	Koli Adet	Fiyat (₺)
010 104 000095	SW-ER60TE Ø60 mm PLASTİK ACİL DURDURMA + EMERGENCY ROZETİ (KALIN TİP) LAZER BASKI	50	29,82
010 104 000096	SW-ER60EN-Y Ø60 mm PLASTİK EMERGENCY ROZETİ (İNCE TİP) LAZER BASKI	50	22,59
010 093 000003	ACİL DURDURMA ETİKETİ	50	21,74
010 090 050008	SW-AKKM EMNİYET BASMA DÜĞMESİ MUHAFAZA	50	20,96
010 104 000101	SW-AKK ACİL STOP KORUMA KAPAĞI	50	41,75
010 104 000102	SW-AKKY ACİL STOP KORUMA KAPAĞI	50	42,94
010 104 000104	SW-MKKY MANDAL BUTON KORUMA KAPAĞI	50	41,75



999 999 995000

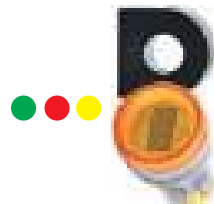

999 999 995001

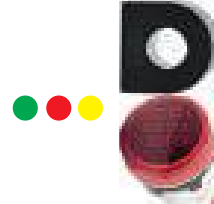

999 999 995002

## VOLTMETRE VE AMPERMETRE

Ürün Kodu	Ürün Adı	Koli Adet	Fiyat (₺)
999 999 995000	22 mm VOLTMETRE PLASTİK LED GÖSTERGELİ 12-500V AC	10	229,01
999 999 995001	22 mm AMPERMETRE (AKIM TRAFOLU) PLS. LED GÖS. 1A-100A AC / 60-380V AC	10	441,39
999 999 995002	22 mm VOLT + AMPERMETRE (AKIM TRAFOLU) PLS. LED GÖS. 12-500V AC / 1A-100A AC	10	562,50



010 090 010001



010 090 010005



010 090 010006



010 090 010007



010 090 010008



010 090 010009



010 090 010010

## MUTLUSAN SİNYAL VE KUMANDA BUTONLARI

Ürün Kodu	Ürün Adı	Koli Adet	Fiyat (₺)
010 090 010001	10 mm KABLOLU SİNYAL ARMATÜRÜ	100	19,44
010 090 010005	14 mm SİNYAL ARMATÜRÜ - 12V	50	24,40
010 090 010006	14 mm SİNYAL ARMATÜRÜ - 24V	50	24,40
010 090 010007	14 mm SİNYAL ARMATÜRÜ - 220V	50	24,40
010 090 010008	22 mm SİNYAL ARMATÜRÜ - 12V	24	27,55
010 090 010009	22 mm SİNYAL ARMATÜRÜ - 24V	24	27,55
010 090 010010	22 mm SİNYAL ARMATÜRÜ - 220V	24	27,55



010 090 010004



010 090 070002



010 111 070001



010 111 070002



010 111 070003



010 111 070004

## MUTLUSAN SİNYAL VE KUMANDA BUTONLARI

Ürün Kodu	Ürün Adı	Koli Adet	Fiyat (₺)
010 090 010004	22 mm SİNYAL ARM. LEDLİ - 220V	24	37,27
010 090 070002	22 mm SİNYAL ARM. LEDLİ - 24V	24	36,96
010 111 070001	BUZZER LEDLİ - 220V	24	168,28
010 111 070002	BUZZER LEDLİ - 24V	24	168,28
010 111 070003	BUZZER - 220V	24	134,18
010 111 070004	BUZZER LEDLİ - 24V	24	134,18



Ürün Kodu	Çap (Ø)	Ürün Adı	Çalışma Şekli	Besleme Gerilimi	Adet	Fiyat
<b>PRO SERİSİ 1 KATLI RGB METAL MULTİ RENK İKAZ LAMBALARI</b>						
129 087 000606	Ø50	PRO-X324	SABİT	24V DC	1	182,94 \$
129 087 000607		PRO-X324B	SABİT + BUZZER	24V DC	1	221,06 \$
<b>T6 SERİSİ RGB METAL MULTİ RENK İKAZ LAMBALARI</b>						
129 087 000671	Ø60	M-T6-243	MULTİ	24 V DC	1	38,12 \$
129 087 000672		M-T6-223	MULTİ	220V AC	1	45,75 \$
129 087 000673		MB-T6-243	MULTİ + BUZZER	24V DC	1	45,75 \$
129 087 000674		MB-T6-223	MULTİ + BUZZER	220V AC	1	53,38 \$
<b>R6 SERİSİ RGB METAL MULTİ RENK İKAZ LAMBALARI</b>						
129 087 000675	Ø60	M-R6-243	MULTİ	24 V DC	1	38,12 \$
129 087 000676		M-R6-223	MULTİ	220V AC	1	45,75 \$
129 087 000677		MB-R6-243	MULTİ + BUZZER	24V DC	1	45,75 \$
129 087 000678		MB-R6-223	MULTİ + BUZZER	220V AC	1	53,38 \$
<b>T7K SERİSİ RGB METAL MULTİ RENK İKAZ LAMBALARI</b>						
129 087 000679	Ø70	M-T7K-243	MULTİ	24 V DC	1	38,12 \$
129 087 000680		M-T7K-223	MULTİ	220V AC	1	45,75 \$
129 087 000681		MB-T7K-243	MULTİ + BUZZER	24V DC	1	45,75 \$
129 087 000682		MB-T7K-223	MULTİ + BUZZER	220V AC	1	53,38 \$
<b>R7K SERİSİ RGB METAL MULTİ RENK İKAZ LAMBALARI</b>						
129 087 000683	Ø70	M-R7K-243	MULTİ	24 V DC	1	38,12 \$
129 087 000684		M-R7K-223	MULTİ	220V AC	1	45,75 \$
129 087 000685		MB-R7K-243	MULTİ + BUZZER	24V DC	1	45,75 \$
129 087 000686		MB-R7K-223	MULTİ + BUZZER	220V AC	1	53,38 \$
<b>V7K SERİSİ RGB METAL MULTİ RENK İKAZ LAMBALARI</b>						
129 087 000687	Ø70	M-V7K-243	MULTİ	24 V DC	1	38,12 \$
129 087 000688		M-V7K-223	MULTİ	220V AC	1	45,75 \$
129 087 000689		MB-V7K-243	MULTİ + BUZZER	24V DC	1	45,75 \$
129 087 000690		MB-V7K-223	MULTİ + BUZZER	220V AC	1	53,38 \$
<b>QH SERİSİ RGB METAL MULTİ RENK İKAZ LAMBALARI</b>						
129 087 000691	Ø70	M-QH-324	MULTİ	24 V DC	1	60,98 \$
129 087 000692		M-QH-322	MULTİ	220V AC	1	68,61 \$
129 087 000693		MB-QH-324	MULTİ + BUZZER	24V DC	1	68,61 \$
129 087 000694		MB-QH-322	MULTİ + BUZZER	220V AC	1	76,23 \$
<b>BH SERİSİ RGB METAL MULTİ RENK İKAZ LAMBALARI</b>						
129 087 000695	Ø70	M-BH-324	MULTİ	24 V DC	1	60,98 \$
129 087 000696		M-BH-322	MULTİ	220V AC	1	68,61 \$
129 087 000697		MB-BH-324	MULTİ + BUZZER	24V DC	1	68,61 \$
129 087 000698		MB-BH-322	MULTİ + BUZZER	220V AC	1	76,23 \$
<b>BH SERİSİ MULTİ 105 dB 1-2-3 KATLI BORULU KORNALAR</b>						
129 087 000401		M-BH-241	MULTİ	24 V DC	1	60,98 \$
129 087 000403		M-BH-221	MULTİ	220V AC	1	68,61 \$
129 087 000405		M-BH-242	MULTİ	24 V DC	1	91,49 \$
129 087 000407		M-BH-222	MULTİ	220V AC	1	106,72 \$
129 087 000409		M-BH-243	MULTİ	24 V DC	1	106,72 \$
129 087 000411		M-BH-223	MULTİ	220V AC	1	121,98 \$
<b>QH SERİSİ MULTİ 105 dB 1-2-3 KATLI BORULU KORNALAR</b>						
129 087 000400		M-QH-241	MULTİ	24 V DC	1	60,98 \$
129 087 000402		M-QH-221	MULTİ	220V AC	1	68,61 \$
129 087 000404		M-QH-242	MULTİ	24 V DC	1	91,49 \$
129 087 000406		M-QH-222	MULTİ	220V AC	1	106,72 \$
129 087 000408		M-QH-243	MULTİ	24 V DC	1	106,72 \$
129 087 000410		M-QH-223	MULTİ	220V AC	1	121,97 \$
<b>B-B SERİSİ Ø70 BORULU KORNALAR (SÜREKLİ - KESİK KESİK)</b>						
129 087 000230		B-B-24	95dB/30cm	24 V	1	39,64 \$
129 087 000233		B-B-220	95dB/30cm	220V	1	39,64 \$
129 087 000631		B-BH-24	115dB/30cm	24 V	1	47,27 \$
129 087 000632		B-BH-220	115dB/30cm	220V	1	47,27 \$
<b>B-Q SERİSİ Ø70 BORULU KORNALAR (SÜREKLİ - KESİK KESİK)</b>						
129 087 000235		B-Q-24	95dB/30cm	24 V	1	39,64 \$
129 087 000238		B-Q-220	95dB/30cm	220V	1	39,64 \$
129 087 000633		B-QH-24	115dB/30cm	24 V	1	47,27 \$
129 087 000634		B-QH-220	115dB/30cm	220V	1	47,27 \$
<b>FM SERİSİ BUZZER (SÜREKLİ - KESİK KESİK)</b>						
129 087 000245		FM-12A-905AL70	90dB/30cm	12 V	1	24,39 \$
129 087 000246		FM-12Q-905L70	95dB/60cm	12 V	1	24,39 \$
129 087 000247		FM-24C-905L70	92dB/100cm	24 V	1	24,39 \$
129 087 000248		FM-220A-905AL70	95dB/30cm	220V	1	27,44 \$
129 087 000249		FM-24C-900L700	92dB/100cm	24 V	1	21,34 \$
129 087 000250		FM-220A-905A	90dB/300cm	220 V	1	27,44 \$
129 087 000251		FM-12A-905A	90dB/30cm	12 V	1	24,39 \$
129 087 000252		FM-120Q-905	90dB/30cm	12 V	1	21,34 \$



Ürün Kodu	Ürün Adı	Çalışma Şekli	Besleme Gerilimi	Adet	Fiyat
<b>PRO SERİSİ 1 KATLI IŞIKLI KOLONLAR</b>					
129 087 000608	PRO-241	SABİT	24V DC	1	189,75 \$
129 087 000609	PRO-241B	SABİT + BUZZER	24V DC	1	213,47 \$
<b>PRO SERİSİ 2 KATLI IŞIKLI KOLONLAR</b>					
129 087 000610	PRO-242	SABİT	24 V DC	1	213,47 \$
129 087 000611	PRO-242B	SABİT + BUZZER	220V AC	1	237,18 \$
<b>PRO SERİSİ 3 KATLI IŞIKLI KOLONLAR</b>					
129 087 000612	PRO-242	SABİT	24 V DC	1	237,18 \$
129 087 000613	PRO-242B	SABİT + BUZZER	220V AC	1	260,9 \$
<b>PRO SERİSİ 4 KATLI IŞIKLI KOLONLAR</b>					
129 087 000614	PRO-244	SABİT	24 V DC	1	260,9 \$
129 087 000615	PRO-244B	SABİT + BUZZER	220V AC	1	284,62 \$
<b>PRO SERİSİ 5 KATLI IŞIKLI KOLONLAR</b>					
129 087 000616	PRO-245	SABİT	24 V DC	1	284,62 \$
129 087 000617	PRO-245B	SABİT + BUZZER	220V AC	1	308,35 \$
<b>T5 SERİSİ 1 KATLI IŞIKLI KOLONLAR</b>					
129 087 000278	S-T5-241	SABİT	24 V DC	1	38,12 \$
129 087 000279	S-T5-221	SABİT	220V AC	1	45,75 \$
129 087 000281	F-T5-241	FLAŞÖRLÜ	24V DC	1	59,46 \$
129 087 000282	F-T5-221	FLAŞÖRLÜ	220V AC	1	64,03 \$
129 087 000284	Ç-T5-241	ÇAKAR	24 V DC	1	59,46 \$
129 087 000285	Ç-T5-221	ÇAKAR	220V AC	1	64,03 \$
129 087 000287	SB-T5-241	SABİT+BUZZER	24V DC	1	62,51 \$
129 087 000288	SB-T5-221	SABİT+BUZZER	220V AC	1	70,13 \$
129 087 000290	FB-T5-241	FLAŞÖRLÜ+BUZZER	24V DC	1	74,7 \$
129 087 000291	FB-T5-221	FLAŞÖRLÜ+BUZZER	220V AC	1	82,34 \$
<b>T5 SERİSİ 2 KATLI IŞIKLI KOLONLAR</b>					
129 087 000296	S-T5-242	SABİT	24 V DC	1	54,9 \$
129 087 000297	S-T5-222	SABİT	220V AC	1	57,93 \$
129 087 000299	F-T5-242	FLAŞÖRLÜ	24V DC	1	65,56 \$
129 087 000300	F-T5-222	FLAŞÖRLÜ	220V AC	1	77,75 \$
129 087 000302	SB-T5-242	SABİT+BUZZER	24 V DC	1	71,66 \$
129 087 000303	SB-T5-222	SABİT+BUZZER	220V AC	1	79,28 \$
129 087 000305	FB-T5-242	FLAŞÖRLÜ+BUZZER	24V DC	1	80,81 \$
129 087 000306	FB-T5-222	FLAŞÖRLÜ+BUZZER	220V AC	1	88,44 \$
<b>T5 SERİSİ 3 KATLI IŞIKLI KOLONLAR</b>					
129 087 000308	S-T5-243	SABİT	24 V DC	1	57,93 \$
129 087 000309	S-T5-223	SABİT	220V AC	1	62,51 \$
129 087 000311	F-T5-243	FLAŞÖRLÜ	24V DC	1	74,7 \$
129 087 000312	F-T5-223	FLAŞÖRLÜ	220V AC	1	82,34 \$
129 087 000314	SB-T5-243	SABİT+BUZZER	24 V DC	1	89,97 \$
129 087 000315	SB-T5-223	SABİT+BUZZER	220V AC	1	97,57 \$
129 087 000317	FB-T5-243	FLAŞÖRLÜ+BUZZER	24V DC	1	97,57 \$
129 087 000318	FB-T5-223	FLAŞÖRLÜ+BUZZER	220V AC	1	106,72 \$
<b>T7 SERİSİ 1 KATLI IŞIKLI KOLONLAR</b>					
129 087 000651	M-T7-241	MULTİ	24 V DC	1	38,16 \$
129 087 000652	M-T7-221	MULTİ	220V AC	1	45,79 \$
129 087 000653	MB-T7-241	MULTİ + BUZZER	24V DC	1	45,75 \$
129 087 000654	MB-T7-221	MULTİ + BUZZER	220V AC	1	53,38 \$
<b>T7 SERİSİ 2 KATLI IŞIKLI KOLONLAR</b>					
129 087 000655	M-T7-242	MULTİ	24 V DC	1	51,89 \$
129 087 000656	M-T7-222	MULTİ	220V AC	1	61,05 \$
129 087 000657	MB-T7-242	MULTİ + BUZZER	24V DC	1	60,97 \$
129 087 000658	MB-T7-222	MULTİ + BUZZER	220V AC	1	68,60 \$
<b>T7 SERİSİ 3 KATLI IŞIKLI KOLONLAR</b>					
129 087 000659	M-T7-243	MULTİ	24 V DC	1	61,05 \$
129 087 000660	M-T7-223	MULTİ	220V AC	1	79,20 \$
129 087 000661	MB-T7-243	MULTİ + BUZZER	24V DC	1	68,60 \$
129 087 000662	MB-T7-223	MULTİ + BUZZER	220V AC	1	76,23 \$
<b>T7 SERİSİ 4 KATLI IŞIKLI KOLONLAR</b>					
129 087 000663	M-T7-244	MULTİ	24 V DC	1	74,25 \$
129 087 000664	M-T7-224	MULTİ	220V AC	1	82,5 \$
129 087 000665	MB-T7-244	MULTİ + BUZZER	24V DC	1	82,5 \$
129 087 000666	MB-T7-224	MULTİ + BUZZER	220V AC	1	99,38 \$
<b>T7 SERİSİ 5 KATLI IŞIKLI KOLONLAR</b>					
129 087 000667	M-T7-245	MULTİ	24 V DC	1	82,5 \$
129 087 000668	M-T7-225	MULTİ	220V AC	1	90,75 \$
129 087 000669	MB-T7-245	MULTİ + BUZZER	24V DC	1	90,75 \$
129 087 000670	MB-T7-225	MULTİ + BUZZER	220V AC	1	99,37 \$



İŞIKLI KOLONLARDA KIRMIZI SABİT RENKTİR. DİĞER RENKLER SİPARİŞLE YAPILIP, İADESİ YOKTUR.



Ürün Kodu	Çap (Ø)	Ürün Adı	Çalışma Şekli	Besleme Gerilimi	Adet	Fiyat
-----------	---------	----------	---------------	------------------	------	-------

#### T6 SERİSİ MULTİ FONKSİYON İKAZ LAMBALARI

129 087 000441	Ø60	M-T6-24K	MULTİ	24 V DC	1	30,49 \$
129 087 000442		M-T6-22K	MULTİ	220V AC	1	43,6 \$
129 087 000443		MB-T6-24K	MULTİ + BUZZER	24V DC	1	38,12 \$
129 087 000444		MB-T6-22K	MULTİ + BUZZER	220V AC	1	45,75 \$

#### R6 SERİSİ MULTİ FONKSİYON İKAZ LAMBALARI

129 087 000635	Ø60	M-R6-24K	MULTİ	24 V DC	1	30,49 \$
129 087 000636		M-R6-22K	MULTİ	220V AC	1	38,12 \$
129 087 000637		MB-R6-24K	MULTİ + BUZZER	24V DC	1	38,12 \$
129 087 000638		MB-R6-22K	MULTİ + BUZZER	220V AC	1	45,75 \$

#### F7 SERİSİ 12...80V/DC MOBİL UYGULAMA İÇİN İKAZ LAMBALARI

129 087 000622	Ø70	M-F7-24K	MULTİ	24 V DC	1	60,98 \$
129 087 000623		M-F7-22K	MULTİ	220V AC	1	68,61 \$
129 087 000624		MB-F7-24K	MULTİ + BUZZER	24V DC	1	68,61 \$
129 087 000625		MB-F7-22K	MULTİ + BUZZER	220V AC	1	76,23 \$

#### T7K SERİSİ MULTİ FONKSİYON İKAZ LAMBALARI

129 087 000639	Ø70	M-T7K-24K	MULTİ	24 V DC	1	38,16 \$
129 087 000640		M-T7K-22K	MULTİ	220V AC	1	45,79 \$
129 087 000641		MB-T7K-24K	MULTİ + BUZZER	24V DC	1	45,79 \$
129 087 000642		MB-T7K-22K	MULTİ + BUZZER	220V AC	1	53,38 \$

#### V8 SERİSİ MULTİ FONKSİYON Q84 İKAZ LAMBALARI

129 087 000445	Ø80	M-V8-24K	MULTİ	24 V DC	1	60,98 \$
129 087 000446		M-V8-22K	MULTİ	220V AC	1	68,61 \$
129 087 000447		MB-V8-24K	MULTİ + BUZZER	24V DC	1	68,61 \$
129 087 000448		MB-V8-22K	MULTİ + BUZZER	220V AC	1	76,23 \$

#### T8 SERİSİ MULTİ FONKSİYON İKAZ LAMBALARI

129 087 000449	Ø80	M-T8-24K	MULTİ	24 V DC	1	65,56 \$
129 087 000450		M-T8-22K	MULTİ	220V AC	1	73,18 \$
129 087 000451		MB-T8-24K	MULTİ + BUZZER	24V DC	1	73,18 \$
129 087 000452		MB-T8-22K	MULTİ + BUZZER	220V AC	1	80,81 \$

#### VT8 SERİSİ MULTİ FONKSİYON Q84 İKAZ LAMBALARI

129 087 000453	Ø80	M-VT8-24K	MULTİ	24 V DC	1	65,56 \$
129 087 000454		M-VT8-22K	MULTİ	220V AC	1	73,18 \$
129 087 000455		MB-VT8-24K	MULTİ + BUZZER	24V DC	1	73,18 \$
129 087 000456		MB-VT8-22K	MULTİ + BUZZER	220V AC	1	80,81 \$

#### T9 SERİSİ MULTİ FONKSİYON İKAZ LAMBALARI

129 087 000457	Ø90	M-T9-24K	MULTİ	24 V DC	1	60,98 \$
129 087 000458		M-T9-22K	MULTİ	220V AC	1	68,61 \$
129 087 000459		MB-T9-24K	MULTİ + BUZZER	24V DC	1	68,61 \$
129 087 000460		MB-T9-22K	MULTİ + BUZZER	220V AC	1	76,23 \$

#### T10 SERİSİ MULTİ FONKSİYON İKAZ LAMBALARI

129 087 000643	Ø100	M-T10-24K	MULTİ	24 V DC	1	68,61 \$
129 087 000644		M-T10-22K	MULTİ	220V AC	1	76,23 \$
129 087 000645		MB-T10-24K	MULTİ + BUZZER	24V DC	1	76,23 \$
129 087 000646		MB-T10-22K	MULTİ + BUZZER	220V AC	1	83,86 \$

#### T12 SERİSİ MULTİ FONKSİYON İKAZ LAMBALARI

129 087 000647	Ø120	M-T12-24K	MULTİ	24 V DC	1	76,23 \$
129 087 000648		M-T12-22K	MULTİ	220V AC	1	83,86 \$
129 087 000649		MB-T12-24K	MULTİ + BUZZER	24V DC	1	83,86 \$
129 087 000650		MB-T12-22K	MULTİ + BUZZER	220V AC	1	91,49 \$

#### HEAVY DUTY SERİSİ İKAZ LAMBALARI

Ürün Kodu	Ürün Adı	Çalışma Şekli	Besleme Gerilimi	Adet	Fiyat
129 087 000619	HD-22K	MULTİ	12-24V DC/220V AC	1	182,94 \$
129 087 000618	HD-22B	7 FARKLI SES	12-24V DC/220V AC	1	236,32 \$
129 087 000620	HD-22BK	MULTİ IŞIK+7 FARKLI SES	12-24V DC/220V AC	1	495,5 \$

## Eko Serisi Koli Bazında Proje Ürünleri



## EKO SERİSİ

EKO SERİSİ ABS PANO (KUTUSUZ)			
Ürün Kodu	Ürün Adı	Koli Adeti	Fiyat
050 901 203013	EKO 20X30X13 ABS OPAK PANO	15	437,58
050 901 253515	EKO 25X35X15 ABS OPAK PANO	12	651,86
050 901 304017	EKO 30X40X17 ABS OPAK PANO	10	869,14
050 901 304022	EKO 30X40X22 ABS OPAK PANO	8	1.017,22
050 901 305019	EKO 35X50X19 ABS OPAK PANO	5	1.242,00
050 901 405018	EKO 40X50X18 ABS OPAK PANO	5	1.397,58
050 901 405024	EKO 40X50X24 ABS OPAK PANO	4	1.548,53
050 901 406020	EKO 40X60X20 ABS OPAK PANO	4	1.755,38
050 901 506022	EKO 50X60X22 ABS OPAK PANO	4	2.428,57
050 901 507025	EKO 50X70X25 ABS OPAK PANO	3	2.552,73
050 901 608026	EKO 60X80X26 ABS OPAK PANO	3	4.020,86
EKO SERİSİ KLEMENSSİZ (KUTUSUZ) OTOMAT KUTUSU			
Ürün Kodu	Ürün Adı	Koli Adeti	Fiyat
050 931 1X0002	EKO KLEMENSSİZ 2 Lİ S/Ü / S/A SİGORTA KUTUSU	40	63,21
050 931 1X0004	EKO KLEMENSSİZ 4 LÜ S/Ü / S/A SİGORTA KUTUSU	27	95,45
050 931 1X0006	EKO KLEMENSSİZ 6 Lİ S/Ü / S/A SİGORTA KUTUSU	24	115,48
050 931 1X0008	EKO KLEMENSSİZ 8 Lİ S/Ü / S/A SİGORTA KUTUSU	16	161,44
050 931 1X0012	EKO KLEMENSSİZ 12 Lİ S/Ü / S/A SİGORTA KUTUSU	18	207,88
050 931 1X0018	EKO KLEMENSSİZ 18 Lİ S/Ü / S/A SİGORTA KUTUSU	12	273,00
050 931 1X0024	EKO KLEMENSSİZ 24 LÜ S/Ü / S/A SİGORTA KUTUSU	11	334,29
050 931 1X0036	EKO KLEMENSSİZ 36 Lİ S/Ü / S/A SİGORTA KUTUSU	8	400,65
EKO SERİSİ KLEMENSLİ (KUTUSUZ) OTOMAT KUTUSU			
Ürün Kodu	Ürün Adı	Koli Adeti	Fiyat
050 931 2X0004	EKO KLEMENSLİ 4 LÜ S/Ü / S/A SİGORTA KUTUSU	27	102,95
050 931 2X0006	EKO KLEMENSLİ 6 Lİ S/Ü / S/A SİGORTA KUTUSU	24	128,76
050 931 2X0008	EKO KLEMENSLİ 8 Lİ S/Ü / S/A SİGORTA KUTUSU	16	190,91
050 931 2X0012	EKO KLEMENSLİ 12 Lİ S/Ü / S/A SİGORTA KUTUSU	18	223,62
050 931 2X0018	EKO KLEMENSLİ 18 Lİ S/Ü / S/A SİGORTA KUTUSU	12	329,71
050 931 2X0024	EKO KLEMENSLİ 24 LÜ S/Ü / S/A SİGORTA KUTUSU	11	362,11
050 931 2X0036	EKO KLEMENSLİ 36 Lİ S/Ü / S/A SİGORTA KUTUSU	8	442,34
EKO SERİSİ BUATLAR (KUTUSUZ)			
Ürün Kodu	Ürün Adı	Koli Adeti	Fiyat
050 905 285285	EKO 85X85X40 KARE ANTİGRON BUAT	200	15,05
050 905 080040	EKO 80X40X35 TERMOPLASTİK BUAT	200	13,89
050 905 085085	EKO 85X85X50 TERMOPLASTİK BUAT	160	23,10
050 905 185185	EKO 85X85X50 TERMOPLASTİK BUAT (VİDALI)	130	35,25
050 905 080120	EKO 80X120X55 TERMOPLASTİK BUAT	85	42,83
050 905 100100	EKO 100X100X50 TERMOPLASTİK BUAT	84	42,55
050 905 110110	EKO 110X110X74 TERMOPLASTİK BUAT	104	47,41
050 905 120150	EKO 120X150X80 TERMOPLASTİK BUAT	30	73,29
050 905 150150	EKO 150X150X80 TERMOPLASTİK BUAT	57	81,57
050 905 190150	EKO 190X150X80 TERMOPLASTİK BUAT	22	91,51
050 905 200200	EKO 200X200X80 TERMOPLASTİK BUAT	32	109,74
050 905 210120	EKO 210X120X74 TERMOPLASTİK BUAT	28	95,13
050 905 260150	EKO 260X150X80 TERMOPLASTİK BUAT	19	127,50
050 905 280210	EKO 280X210X74 TERMOPLASTİK BUAT	17	162,39
050 905 380280	EKO 380X280X90 TERMOPLASTİK BUAT	10	235,27



\* Koli bazında proje ürünleri yıl sonu prim sistemine dahil değildir.

\* X yerine sıva üstü için 0, sıva altı için 1 rakamını yazınız.

# Promex Rakor

## PLASTİK KABLO RAKORU



IP 68



Ürün Kodu	Ürün Adı	Kablo Sıkma Çapı	Delik Çapı	Fiyat
<b>PROMEX SMART PLASTİK KABLO RAKORU</b>				
057 097 411X16	16'LİK SMART KABLO RAKORU	5-10 mm	16 mm	0,9417 €
057 097 412X20	20'LİK SMART KABLO RAKORU	6-12 mm	20 mm	0,9917 €
057 097 422X25	25'LİK SMART KABLO RAKORU	11-17 mm	25 mm	1,4310 €
057 097 422X32	32'LİK SMART KABLO RAKORU	15-21 mm	32 mm	2,4075 €
057 097 422X40	40'LİK SMART KABLO RAKORU	19-28 mm	40 mm	4,0320 €



Ürün Kodu	Ürün Adı	Kablo Sıkma Çapı	Delik Çapı	Fiyat
<b>PROMEX PG PLASTİK KABLO RAKORU</b>				
057 097 211X07	PG 7 PLASTİK KABLO RAKORU	3-6.5 mm	13	0,3007 €
057 097 212X09	PG 9 PLASTİK KABLO RAKORU	4-8 mm	15,5	0,3153 €
057 097 213X11	PG 11 PLASTİK KABLO RAKORU	5-10 mm	19	0,3740 €
057 097 214X14	PG 13,5 PLASTİK KABLO RAKORU	6-12 mm	20,5	0,4253 €
057 097 215X16	PG 16 PLASTİK KABLO RAKORU	10-14 mm	22,5	0,4921 €
057 097 216X21	PG 21 PLASTİK KABLO RAKORU	13-18 mm	28,5	0,7764 €
057 097 217X29	PG 29 PLASTİK KABLO RAKORU	18-25 mm	37,5	1,4156 €
057 097 218X36	PG 36 PLASTİK KABLO RAKORU	22-32 mm	47,5	2,4058 €
057 097 219X42	PG 42 PLASTİK KABLO RAKORU	30-38 mm	54,5	2,9592 €
057 097 220X48	PG 48 PLASTİK KABLO RAKORU	34-44 mm	60,5	3,3447 €



Ürün Kodu	Ürün Adı	Kablo Sıkma Çapı	Delik Çapı (Diş Çekilmiş)	Delik Çapı (Diş Çekme)	Fiyat
<b>PROMEX METRİK PLASTİK KABLO RAKORU</b>					
057 097 310X12	M12X1,5 METRİK PLASTİK RAKOR	3-6,5 mm	12 mm	10,5 mm	0,3923 €
057 097 311X16	M16X1,5 METRİK PLASTİK RAKOR	5-10 mm	16 mm	14,5 mm	0,3800 €
057 097 312X20	M20X1,5 METRİK PLASTİK RAKOR	6-12 mm	20 mm	18,5 mm	0,4294 €
057 097 313X20	M20X1,5 METRİK PLASTİK RAKOR	10-14 mm	20 mm	18,5 mm	0,5358 €
057 097 314X20	M20X1,5 METRİK PLASTİK RAKOR	10-14 mm	20 mm	18,5 mm	0,5386 €
057 097 315X25	M25X1,5 METRİK PLASTİK RAKOR	13-18 mm	25 mm	23,5 mm	0,7897 €
057 097 316X25	M25X1,5 METRİK PLASTİK RAKOR	13-18 mm	25 mm	23,5 mm	0,8400 €
057 097 317X32	M32X1,5 METRİK PLASTİK RAKOR	18-25 mm	32 mm	30,5 mm	1,6680 €
057 097 318X40	M40X1,5 METRİK PLASTİK RAKOR	22-32 mm	40 mm	38,5 mm	2,6535 €
057 097 319X50	M50X1,5 METRİK PLASTİK RAKOR	30-38 mm	50 mm	48,5 mm	3,4937 €
057 097 320X63	M63X1,5 METRİK PLASTİK RAKOR	34-44 mm	63 mm	61,5 mm	3,9947 €



Bu ürün kodlarında X ürün rengini belirtmektedir. Sipariş vereceğiniz zaman ürün kodunda X yazan yere aşağıdaki renk kodlarından bir tanesini yazmanız gerekir

0 = Açık gri

1 = Siyah

3 = Gri

\*Smart rakorların çıkartma somunları harici olarak satılmaktadır.



Promex Rakorlar Hakkında  
Daha fazla Bilgi için



#### **Mutlusan Plastik Elektrik San ve Tic. A.Ş.**

İkitelli Org.San. Bölgesi Mahallesi Enkoop Cad.  
No:7 Başakşehir- İstanbul  
Tel : +90 (212) 485 05 44 (PBX)  
Faks : +90 (212) 485 10 12

#### **Karaköy Şube**

Okçumusa Cad. Güneşhan İş Hanı No : 24/10  
Karaköy-İstanbul  
Tel : +90 (212) 237 06 02 (PBX)  
Fax: +90 (212) 237 77 47

#### **Perpa Şube**

Perpa Tic. Merkezi. A Blok Kat: 2  
No: 9-009 Okmeydanı - İstanbul  
Tel : +90 (212) 320 05 78 (PBX)  
Fax: +90 (212) 320 05 81

[mutlusan.com.tr](http://mutlusan.com.tr)

